



# Perle 10G Media Converter Modules

---

## Installation Guide

**CM-10G-ST**

**C-10G-ST**

**CM-10G-XT**

**C-10G-XT**

**CM-10G-XTX**

**C-10G-XTX**

**CM-10G-XTSH**

**C-10G-XTSH**

**CM-10G-XTXH**

**C-10G-XTXH**



# Overview

This document contains instructions necessary for the installation and operation of the Perle 10G Media Converter modules that are used in conjunction with a Perle Media Converter chassis. Each module contains two pluggable transceiver ports that permit connections of SFP+ fiber, XFP fiber and copper modules. The C model modules are the unmanaged modules and the CM models are the managed modules. For information on the management options of the CM modules refer to the Perle MCR-MGT User's Guide that came with your Perle Management Module. The Cx-10G modules support low power transceivers, whereas the Cx-10G-XTSH and Cx-10G-XTXH support high power (power level 4) transceivers. The high power modules take two slots within a Perle Media Converter chassis. All combination of modules within the chassis cannot exceed the chassis power input consumption. The full power consumption for Perle Media Converter chassis can be found on the Perle website.

Models	Port 1	Port 2
CM-10G-STC	SFP+	SFP+
C-10G-STC	SFP+	SFP+
CM-10G-XTS	XFP	SFP+
C-10G-XTS	XFP	SFP+
CM-10G-XTX	XFP	XFP
C-10G-XTX	XFP	XFP
High Power Models	Port 1	Port 2
CM-10G-XTSH	XFP	SFP+
C-10G-XTSH	XFP	SFP+
CM-10G-XTXH	XFP	XFP
C-10G-XTXH	XFP	XFP

**Note:** *The Cx-10G media converter modules can be populated with two 1G fiber/copper modules to operate at 1G. However with 1G modules the Cx-10G does not support the Loopback Auto Detect feature.*

# Getting to know your Cx-10G Media Converter Module

Your Cx-10G Media Converter module package includes:

- A Cx-10G Media Converter module with two pluggable transceiver ports
- This guide

## Cx-10G Front View

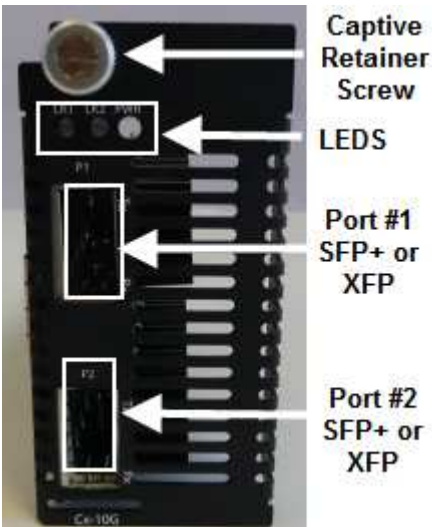

## Installation

The default switch settings (all switches in the UP position) will work for most installations. The default Auto-Jumper is set to Auto. These are the steps required to configure the Perle 10G Media Converter module:

1. Set the Auto-Jumper switch. (optional)
2. Set the DIP switch settings. (optional)
3. Install the module into the chassis. (See Installing Modules)

4. Insert appropriate modules into the pluggable transceiver ports.
5. Connect fiber or copper cables to the installed modules.
6. The Media Converter module is automatically powered up.

## Cx-10G-STs

### 1 - Operating Mode

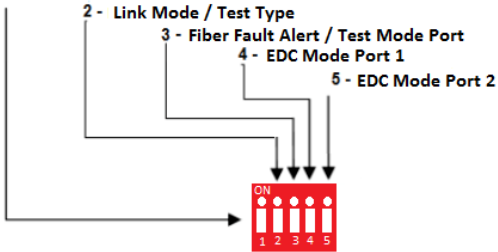

## Cx-10G-XTS, Cx-10G-XTSH

### 1 - Operating Mode

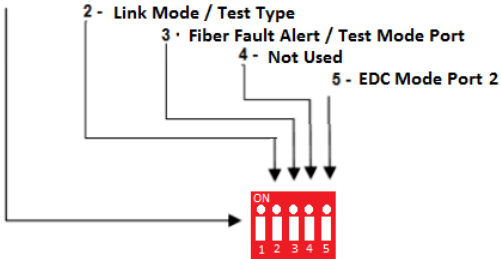

# Cx-10G-XTX, Cx-10G-XTXH

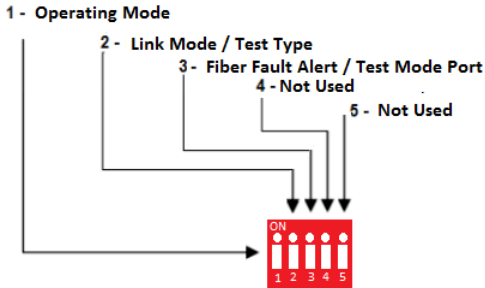

## Installing Modules

1. Set any jumpers and/or DIP switches on the module to the desired operating mode.
2. Gently slide the module into the slot until it becomes flush with the front of the chassis. Light pressure may be needed to seat the module. Do not force the module as you might damage the module. If there is resistance, remove the module and check the module's backplane connector for damage to the pins. If the module's backplane connector is not damaged, try to reinsert the module again
3. Tighten the Captive retainer screw to ensure the module is locked in place.

**Caution:** *Observe electrostatic discharge precautions when installing or removing the module(s) from the Chassis. Failure to observe this caution could result in damage to the module(s) and/or chassis.*

# Auto-Config Jumper (CM models only)

The Auto-Config jumper (J5) is located on the upper edge, at the midpoint of the module.

Strapping pins 1 and 2 of the jumper will set the module in SW mode and strapping pins 2 and 3 will set it in Auto-Config mode.

**Auto:** When set to Auto the module will, at power-up, check its internal flash memory to see if configuration information has been downloaded to it from a management module. If so it will use this configuration as its running configuration. If there is no configuration in flash it will read the settings of the DIP switches and use those as its running configuration.

**SW:** When set to SW (Switch), the module will, at power-up, read the settings of the DIP Switches and use those as its running configuration. It will ignore any configuration information in its flash memory.

**NOTE:** The default jumper setting is Auto

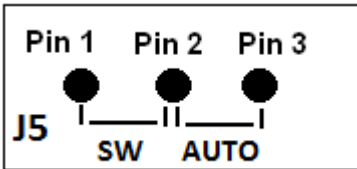

## DIP Switch Settings

The DIP switches are located on the side of the module. The function of the DIP switches vary by model, so please refer to the appropriate model.

**Note:** Switch changes made when the product is powered up take effect immediately and will result in a link reset on both ports.

## Operating Mode (Switch 1)

Switch Position	Mode
Up (default)	Data
Down	Test

**Data:** In Data mode, data will flow between the two fiber connections.

**Test:** Test Mode is used to run diagnostics, enable loopback and for running the Built In Link Tests.

**Note:** *The Operation Mode (Switch 1) affects the function of DIP Switches 2 and 3.*

## Link Mode (Switch 2 – Data Mode)

Switch Position	Mode
Up (default)	Smart Link Pass-Through Mode
Down	Standard Mode

**Smart Link Pass-Through:** In this mode, the link state on one connection is directly reflected through the Media Converter module to the other connection. If fiber link is lost on one of the connections, then the other fiber link will be brought down by the Media Converter module

**Standard Mode:** In this mode, the links can be brought up and down independently of each other. A loss of link on either fiber connection can occur without affecting the other fiber connection

## Test Function (Switch 2 – Test Mode)

Switch Position	Type
Up (default)	Built In Link Test
Down	Loopback

**Built In Link Test:** Switch 2 causes the Cx-10G media converter module to initiate the Built In Link Tests on the specified port. Switch 3 determines the specified port for the Built In Link Tests. If Switch 3 is Up, the tests will be run on Port 1. If the Switch is Down the tests will be run on Port 2. The other port will be disabled during these tests.

These tests consist of the media converter module generating test patterns to be sent out the selected port to the remote media converter module. If the remote media converter module is a supported Perle media converter/module, the port will automatically be put into loopback mode.

**Loopback:** If Switch 2 is down, the specified port will be put into loopback mode. In this mode, the port will be ready to receive the test patterns generated by another Perle media converter/module running the Built In Link Test. Switch 3 determines which port with be put into loopback mode. If the remote device is a supported Perle media converter/module, this unit does not need to be put into test mode and there is no need to set the loopback switch. This will be taken care of by the Auto Loopback Detect feature.

### Illustration of the Built In Link Test / Loopback

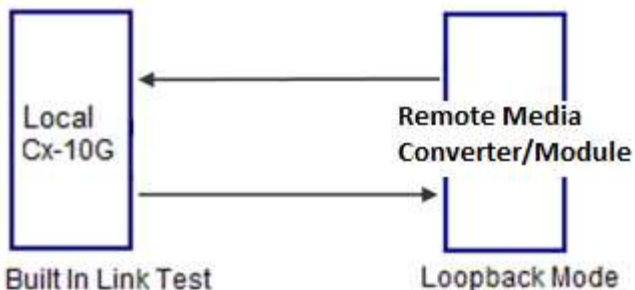



## Local Cx-10G Configuration

Test Mode (Switch 1 – Down)

Test Function (Switch 2 –Up)

## Remote-Cx-10G Configuration

All switches in the Up position

**Note:** *If the remote Media Converter module is not a supported Perle media converter/ module then the remote Media Converter /module will need to be put into loopback mode. See the documentation that came with that Media Converter module.*

### Sequence of Events

1. The Local Cx-10G Media Converter module sends the remote media converter/ module a signal to go into loopback mode.
2. The remote media converter/module turns on loopback mode.
3. Built In Test Data is sent from the Local Cx-10G media converter module to the Remote media converter/ module
4. The Remote media converter module loops the received data back to the Local Cx-10G Media Converter module.
5. Any test errors detected are displayed with the LEDs on the front of the Local Cx-10G Media Converter module
6. The Built in Link Tests continue to run until Switch 1 on the Local Cx-10G Media Converter module is set to Data mode

### Port Selection (Switch 3 – Test Mode)

Switch Position	Port
Up (default)	1
Down	2

When in Test Operating mode (Switch 1- down), this switch determines the port number.

### Fiber Fault Alert (Switch 3 – Data Mode)

Switch Position	Mode
Up (default)	Enabled

Down	Disabled
------	----------

**Enabled:** If the media converter module detects a loss of fiber, the media converter module will immediately notify the fiber link partner that an error condition exists.

If the remote Media Converter module is set up for Fiber Fault Alert (FFA) Enabled and the local media converter is set up with Smart Link Pass-Through, a loss of fiber link on either the transmit or receive line will be passed through to the other fiber connection.

**Disabled:** The Media Converter will not monitor for fiber fault.

### Illustration of the FFA feature

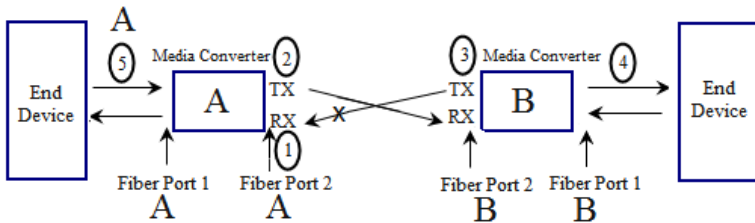

### Media Converter A Configuration

Link Mode—Standard Mode

Fiber Fault Alert

### Media Converter B Configuration

Link Mode—Smart Link Pass through Mode

Fiber Fault Alert

### Sequence of Events

1. Media Converter **A** loses fiber connection (RX).
2. Media Converter **A** notifies the remote Media Converter that there is a fault on the Link.
3. Media Converter **B** detects loss of fiber link on receiver RX.
4. Media Converter **B** turns off transmitter (TX).

***EDC AutoDetect Mode (Switch 4 and Switch 5)  
SFP+ Models only***

Switch Position	Mode
Up (default)	On
Down	Off

**On:** When AutoDetect Mode is turned On, the Cx-10G media converter module will establish the linear or limiting settings based on the contents of the EPROM on the module and module type.

**Off:** When AutoDetect Mode is turned OFF, the Cx-10G media converter module will select the alternative setting from that established by the determination above.

# Operation

## Status LED

The Perle 10G Media converters modules have three status LEDs located on the front panel of the module.

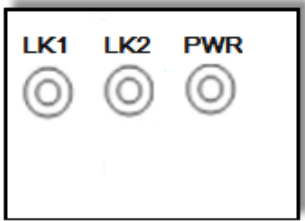

## PWR - Power/Test

**Green On:** Power is on and the module is in normal operation mode.

**Green Blinking *slowly*:** the module is in test or loopback mode.

**Red On** while in Test mode: indicates an error within the last second.

**Red On:** During power up - hardware error detected.

**Red Blinking:** Error detected. (See LK1 LK2 Error Codes).

**Red (*Solid or blinking*):** A module has been inserted that is requesting more than the specified maximum power for that port.

## LK1- Port 1 Activity

**On:** Fiber link present.

**Blinking *quickly*:** Fiber link present and receiving data.

**Blinking *slowly*:** The fiber link has been taken down as a result of Smart Link Pass-Through.

**Blinking one second on, 3 seconds off:** The maximum specified operating temperature within the inserted module has been exceeded.

**Off:** No fiber link present.

## LK2 – Port 2 Activity

**On:** Fiber link present.

**Blinking quickly:** Fiber link present and receiving data.

**Blinking slowly:** The fiber link has been taken down as a result of Smart Link Pass-Through.

**Blinking one second on, 3 seconds off:** The maximum specified operating temperature within the inserted module has been exceeded.

**Off:** No fiber link present.

### ***LK1 LK2 Error Codes***

LK1	LK2	Meaning
Off	Off	Incompatible SFP+ or XFP or speed mismatch on SFP+
Off	On	Power Budget exceeded – XFP's requesting more power than specified port rating.
On	Off	SFP+ or XFP communication error – S-10G unable to communicate with module
On	On	Internal Error

## **Troubleshooting**

### ***General***

- ✓ Ensure power is supplied to the media converter – use of the Perle supplied power adapter is highly recommended.
- ✓ Ensure that SFP+ or XFP modules are of the same speed and are operating properly.
- ✓ Ensure both devices on either end of each fiber are compatible.
- ✓ Ensure all cabling is of the correct type and is in good operating condition.
- ✓ For fiber connections, ensure the RX and TX has been reversed between the 2 media converters.

### ***No connectivity***

If unable to get full connectivity with all DIP switches in the UP position, this procedure is recommended for troubleshooting.

If the remote device is not a Perle media converter/module the remote device needs to be put into loopback mode.

- Initiate test mode on the local device (SW1 Down).

- If the PWR LED turns red or blinks red on a repeated basis, the fiber connection may require further testing.
- If the PWR LED stays green after several seconds of testing, then the link is passing the Built In Link Test. Proceed to testing the other link.

## ***Module Temperature Protection***

All Cx-10G modules come equipped with module temperature protection. Should an inserted SFP+ or XFP module operate above its specified maximum operating temperature, the Cx-10G will reduce the power to that module/s. The Cx-10G will continue to monitor the modules' temperature until the temperature is below the maximum operating temperature and then the Cx-10G will return the module/s to normal operating mode.

## ***Loopback Auto Detect***

Perle Cx-10G media converter modules have the ability to automatically put remote supported Perle media converter/modules into loopback mode. This allows the remote Perle media converter/module to be located in distant or inaccessible locations. The remote Perle media converter/module will remain in loopback mode as long as the tests are in progress.

**Note:** *Depending on the manufacturer some copper cabling may not support our Loopback Auto Detect feature, however Loopback Mode can always be obtained by setting switch 2 to the down position on your Perle Media converter module.*

# Technical Specifications

The following applies to all Perle 10G Media Converter modules.

## Power Input, Consumption 12VDC

STS	1.0A Max, 600mA
XTS	1.2A Max, 800mA
XTX	1.5A Max, 1.0A
XTSH	1.5A Max, 1.0A
XTXH	2.0A Max, 1.4A

Operating Temperature:	0°C -50°C (32°F - 122°F)
Storage Temperature:	-25°C -70°C (-13°F -158°F)
Operating Humidity:	5% to 90% non-condensing
Storage Humidity:	5% to 95% non-condensing
Operating Altitude:	Up to 3,048 m (10,000 ft)
Weight:	0.15 kgs (0.3 lbs)

## Module Support

- MSA compliant SFP+
- MSA complaint Class 1, 2 and 3 XFP modules for the Cx-10G-XTX models and Cx-10G-XTS models.
- MSA complaint Class 1, 2, 3 and 4 XFP for the Cx-10G-XTXH and Cx-10G-XTXSH models.
- 1G copper modules
- 1G fiber modules
- SFP+ supports Cx1 (direct attach) interfaces
- XFP supports Cx4 modules

## Fiber Cabling Requirements

**MM:** 50/125 microns  
62.5/125 microns

**SM:** 9/125 microns

Note: Please refer the product page on the Perle website for the most up to date specifications.

<http://www.perle.com/>

# Compliance Information

## ***FCC***

This product has been found to comply with the limits for a Class A digital device, pursuant to Part 15 of the FCC rules. These limits are designed to provide reasonable protection against harmful interference when the equipment is operated in a commercial environment. This equipment generates, uses, and can radiate radio frequency energy and, if not installed and used in accordance with the instructions in this Guide, may cause harmful interference to radio communications. Operation of this equipment in a residential area is likely to cause harmful interference, in which case the user will be required to correct the interference at his/her own expense.

## ***EN 55022 Class A***

**WARNING** This is a Class A product. In a domestic environment this product may cause radio interference in which case the user may be required to take adequate measures.

## ***EN 55024 Class A***

# Contacting Technical Support

Contact information for the Perle Technical Assistance Center (PTAC) can be found at the link below. A Technical Support Query may be made via this web page.

[www.perle.com/support\\_services/support\\_request.shtml](http://www.perle.com/support_services/support_request.shtml)

# Warranty / Registration

Perle's standard Lifetime Warranty provides customers with return to factory repairs for Perle products that fail under the conditions of the warranty coverage. Details can be found at:

[http://www.perle.com/support\\_services/warranty.shtml](http://www.perle.com/support_services/warranty.shtml)

Copyright © 2012 Perle Systems Limited

All rights reserved. No part of this document may be reproduced or used in any form without written permission from Perle Systems Limited.