

AirborneDirect™

DP5xx/IN5xxx Family User Manual

Revision 1.0

April 2013





International Headquarters

B&B Electronics Mfg. Co. Inc.

707 Dayton Road

Ottawa, IL 61350 USA

Phone (815) 433-5100 -- **General Fax** (815) 433-5105

Website: www.bb-elec.com

European Headquarters

B&B Electronics Ltd.

Westlink Commercial Park

Oranmore, Co. Galway, Ireland

Phone +353 91-792444 -- **Fax** +353 91-792445

Website: www.bb-europe.com

Contents

1.0	Conventions	8
1.1	Terminology	8
1.2	Notes	8
1.3	Caution.....	8
1.4	File Format	8
2.0	Product Description	9
3.0	Features.....	10
4.0	Device Types	11
4.1	Serial	11
4.2	Ethernet	11
4.3	Serial + Ethernet.....	11
4.4	Enterprise Class	12
4.5	Industrial Class	12
5.0	Block Diagram.....	14
6.0	Pin out and Connectors	16
6.1	Serial Ports.....	16
6.2	Ethernet Port.....	17
6.3	Connector Definition	18
6.4	OEM Reset Switch (Factory Reset).....	19
6.5	Enterprise Serial Interface Jumpers	19
6.6	Indicator LED's	20
7.0	Electrical & RF Specification.....	22
7.1	AC Electrical Characteristics – Transmitter.....	24
7.2	Performance/Range.....	24
8.0	Antenna.....	25
8.1	Antenna Selection	25
8.2	Host Board Mounted Antenna	25
8.3	Host Chassis Mounted Antenna.....	26
8.4	Embedded Antenna	26
8.5	Antenna Location	27
8.6	Performance.....	28
9.0	Mechanical Outline – Enterprise Class	30
10.0	Mechanical Outline – Industrial Class	31
11.0	Getting Started.....	32
11.1	Unpack the AirborneDirect™ Device.....	32
11.2	Connect AirborneDirect™ to host	32
11.3	Attach Antenna and Power-up the AirborneDirect™	32
12.0	Configuring Device – Industrial Serial (ABDx-SE-IN5xxx)	33
13.0	Configuring Device – Enterprise Serial (ABDx-SE-DP5xx).....	36
13.1	Connect a Host Computer	36

13.2	Interacting with the AirborneDirect™ device	36
13.3	Determine and Store the Access Point SSID	37
13.4	Determine the Device's IP address	37
13.5	Accessing the Device Using the Web Interface.....	38
13.6	Accessing the Device Using Telnet	38
14.0	Configuring Device – Enterprise/Industrial Ethernet (ABDx-ER-DP5xx/IN5xxx)	39
15.0	Using the Web Interface	42
15.1	Navigation Bar	43
15.2	Feature Links	44
15.3	Navigating the Website.....	44
15.4	Updating a Field	45
15.5	Uploading Certificates.....	46
15.6	Upload Configuration Files.....	47
15.7	Updating Firmware.....	48
16.0	Express Setup Configuration Page.....	51
17.0	Configuring the Wireless Interface.....	54
17.1	Configuring for Infrastructure Networks	54
17.2	Configuring for AdHoc Networks.....	54
18.0	Configuring the Security Settings.....	56
18.1	Configuring for WEP Security.....	56
18.2	Configuring for WPA-PSK Security	57
18.3	Configuring for WPA2-PSK Security	58
18.4	Configuring for PEAP Security	59
19.0	Configuring Network Settings	61
19.1	Configuring DHCP on WLAN Interface	61
19.2	Configuring DHCP on Ethernet Interface.....	62
19.3	Configuring a Static IP Address on WLAN Interface.....	63
19.4	Configuring a Static IP Address on Ethernet Interface	64
20.0	Configuring Serial Device Server	66
20.1	Configuring Serial Port for Access on Telnet Port.....	66
20.2	Configuring Serial Port 1 for Access on Tunnel Port	67
20.3	Configuring Serial Port 2 for Access on Tunnel Port	69
20.4	Configuring Serial Port 1 as TCP Client.....	70
20.5	Configuring Serial Port 2 as TCP Client.....	71
21.0	Installing and Using the Airborne VirtualCOM Driver	73
22.0	Replacing a Serial Cable.....	77
23.0	Configuring Ethernet Adapter	80
23.1	Router Functionality	80
23.1.1	Public Network Interface.....	81
23.1.2	Private Network Interface	82
23.2	Bridge Functionality	85

23.3	MAC Cloning	86
24.0	Web Page Overview	87
	Module Status	88
	Ethernet Status	89
	Ethernet DHCP Clients	90
	Radio Statistics	91
	Ethernet Statistics	92
	Express Setup	93
	WLAN Settings	94
	WLAN Security Settings	95
	Network Settings	97
	Serial Port Settings	99
	Serial Port 2 Settings	100
	Connection Settings	101
	Ethernet Settings	103
	Wireless Routing Settings	104
	Ethernet Routing Settings	105
	Advanced Settings	106
	Upload Configuration File	109
	List Configuration File	110
	Delete Configuration File	111
	Active Configuration	112
	User Configuration	113
	OEM Configuration	114
	Factory Configuration	115
	WPA Configuration	116
	List Certificates	117
	Upload Certificate	118
	Delete Certificate	119
	Network (Home Page)	120
	Discover Airborne Modules	121
	Scan for Access Points	122
	Maintenance (Home Page)	123
	Update Module Firmware	124
	Reset Factory Defaults	125
	Restart Module	126
	Set System Time	127
	Blink the POST LED	128
	Stop Blinking the POST LED	129
25.0	Certification & Regulatory Approvals	130
25.1	FCC Statement	130
25.2	FCC RF Exposure Statement	130
25.3	Information for Canadian Users (IC Notice)	131
25.4	FCC/IC Modular Approval	131
25.5	Regulatory Test Mode Support	132
26.0	Physical & Environmental Approvals	133

Figures

Figure 1 - Enterprise AirborneDirect™ Device.....	12
Figure 2 - Industrial AirborneDirect™ Device.....	13
Figure 3 - ABDx-ER/SE-DP5xx Block Diagram.....	14
Figure 4 - ABDx-ER/SE-IN5xxx Block Diagram.....	15
Figure 5 - DE-9 (DB-9) Connector Pin-out.....	16
Figure 6 - Ethernet Jack Pin Out.....	17
Figure 7- Interface Selection Jumpers.....	20
Figure 8 - Website Login.....	42
Figure 9 - Default Home Page.....	43
Figure 10 - Website Navigation Bar.....	43
Figure 11- Feature Links.....	44
Figure 12 - Airborne Web Page.....	45
Figure 13 - Upload Certificate Web page.....	46
Figure 14 - Upload Configuration Web Page.....	47
Figure 15 - Firmware Update Page.....	49
Figure 16 - Firmware Update in Progress.....	49
Figure 17 - Firmware Update Complete.....	50
Figure 18 - Express Setup Page.....	51
Figure 19 - Ethernet Bridge Functionality.....	80
Figure 20 - Airborne Ethernet Bridge IP Configuration.....	82

Tables

Table 1 – Serial Port Pin Definition.....	16
Table 2 - Serial Ports by Product Class.....	17
Table 3 - Ethernet Connector Pin Out.....	17
Table 4 - Connector Description.....	18
Table 5 - OEM Reset Procedure.....	19
Table 6 - Enterprise LED Indicators.....	20
Table 7 - Industrial LED Indicators.....	21
Table 8- Absolute Maximum Values ¹	22
Table 9 - RF Characteristics – 802.11a/b/g/n.....	22
Table 10 - Supported Data Rates by Band.....	23
Table 11 - Operating Channels.....	23
Table 12 - Radio Typical Performance Range.....	24
Table 13 - Embedded Antenna Options.....	26
Table 14 - SE-IN5xxx Accessing the Web Interface.....	33
Table 15 - UART Authentication.....	36
Table 16 - UART SSID & Authentication.....	37
Table 17 - UART Determine Module's IP Address.....	37
Table 18 – ER-DP5xx/IN5xxx Accessing the Web Interface.....	39
Table 19 - Navigation Bar Items.....	43
Table 20 - Uploading Certificates.....	46
Table 21 - Uploading Configurations.....	47
Table 22 - Updating Firmware.....	50
Table 23 - Express Page Setup.....	51
Table 24 - Configuring Wireless Interface - Infrastructure.....	54
Table 25 - Configuring Wireless Interface - AdHoc.....	55
Table 26 - Configuring for WEP Security.....	56
Table 27 - Configuring for WPA Security.....	57
Table 28 - Configuring for WPA2 Security.....	58
Table 29 - Configuring for PEAP Security.....	59
Table 30 - Configuring DHCP - WLAN.....	61
Table 31 - Configuring DHCP - Ethernet.....	62
Table 32 - Configuring Static IP - WLAN.....	63
Table 33 - Configuring Static IP - Ethernet.....	64
Table 34 – Configure Data Tunnel on Telnet Port.....	66
Table 35 - Data Tunnel using Telnet Port.....	67
Table 36 – Configure Data Tunnel on Serial Port 1 Tunnel Port (TCP).....	68

Table 37 - Data Tunnel using Tunnel Port on Serial Port 1	68
Table 38 – Configure Data Tunnel on Serial Port 2 Tunnel Port (TCP)	69
Table 39 - Data Tunnel using Tunnel Port on Serial Port 2	70
Table 40 - Configure Serial Port 1 as TCP Client.....	70
Table 41 - Configure Serial Port 2 as TCP Client.....	71
Table 42 - Install VCOM.....	73
Table 43 - Cable Replacement - Slave Configuration.....	77
Table 44 - Cable Replacement - Master Configuration	78
Table 45 - Ethernet Adapter interface Configuration - DHCP.....	82
Table 46 - Ethernet Adapter interface Configuration - Static IP	83
Table 47 - Ethernet Adapter interface Configuration.....	86
Table 48 - Regulatory Approvals	130
Table 49 - Modular Approval Grant Numbers	131
Table 50 - Mechanical Approvals.....	133

1.0 Conventions

The following section outlines the conventions used within the document, where convention is deviated from the deviation takes precedence and should be followed. If you have any question related to the conventions used or clarification of indicated deviation please contact B&B Electronics Sales or Wireless Support.

1.1 Terminology

Airborne Enterprise Device Server and AirborneDirect Enterprise Device Server is used in the opening section to describe the devices detailed in this document, after this section the term **module** will be used to describe the devices.

1.2 Notes

A note contains information that requires special attention. The following convention will be used. The area next to the indicator will identify the specific information and make any references necessary.



The area next to the indicator will identify the specific information and make any references necessary.

1.3 Caution

A caution contains information that, if not followed, may cause damage to the product or injury to the user. The shaded area next to the indicator will identify the specific information and make any references necessary.



The area next to the indicator will identify the specific information and make any references necessary.

1.4 File Format

These documents are provided as Portable Document Format (PDF) files. To read them, you need Adobe Acrobat Reader 4.0.5 or higher. For your convenience, Adobe Acrobat Reader is provided on the Radio Evaluation Kit CD. Should you not have the CD, for the latest version of Adobe Acrobat Reader, go to the Adobe Web site (www.adobe.com).

2.0 Product Description

This guide describes the AirborneDirect™ device servers and wireless adapters from B&B Electronics, Inc. AirborneDirect™ is a fully integrated, 802.11 wireless Local Area Network (LAN) connectivity device designed to provide wireless LAN and Internet connectivity in industrial, scientific, medical, and transportation applications where an existing communications interface already exists. The AirborneDirect family of products supports Serial (RS232/422/485), Ethernet and a combination these interfaces in a range of packaging options.

The AirborneDirect™ product family provides true plug-and-play wireless connectivity. By delivering convenient, easy-to-deploy wireless network connectivity, the device servers and adapters significantly reduce the complexities of wireless system deployment and network implementation. At the same time, users can move equipment without the cost and time associated with wired network drops and environment restrictions. This provides flexibility for seasonal demands, line and staffing changes, and more.

The AirborneDirect™ family includes models with single band or dual band radios: the ABDG supports 802.11b/g and the ABDN supports 802.11a/b/g/n.

The AirborneDirect™ Serial Bridges and device servers provide a simple connection between the 802.11 wireless LAN and three leading serial interfaces: RS-232, RS-422, and RS-485. The Bridge acts transparently between any device using these interfaces and a wireless LAN. Using the B&B Electronics virtual communications port Windows device driver OEMs can communicate with their devices from any workstation on the same network as if the workstation and devices were directly attached through a serial port.

The AirborneDirect™ Ethernet Adapter provides a link between the 802.11 wireless LAN and any Ethernet-ready device with an RJ-45 connector. It acts transparently between the device and a wireless LAN. By integrating AirborneDirect™ into existing and legacy platforms, OEMs can significantly enhance their products by delivering increased value and functionality to their entire customer base.

The Airborne family includes the ability to simultaneously use the serial-to-wireless and Ethernet-to-wireless connectivity in the same unit. This capability provides for multiple connections to the same machine or consolidation of multiple wireless units into a single device.

The AirborneDirect™ products open the world of remote device monitoring and management, as well as wide-area data collection, to any device, machine, or plant that has an external serial or Ethernet connection and a network infrastructure. The development kit provides quick and easy access to the Bridge's configuration and functions, while providing OEMs with a platform to develop their branded solutions. The Bridge also provides the capability to perform firmware upgrades that allow new features to be added quickly and easily, protecting your investment.

The Enterprise family includes the most advanced security support available for the device class in the industry, including WPA, WPA2 and full Enterprise support. The devices can be used with the most advanced WLAN networks being deployed today. The Airborne products are based upon the industry leading Airborne device server and wireless adapter technology from B&B Electronics, providing a fully compatible and familiar device interface across the all product ranges. If you've used one of them, you have used them all.

3.0 Features

- 802.11 WiFi Radio with 32bit ARM9 CPU (128Mb SDRAM, 64Mb Flash)
 - ABDG series supports 802.11b/g
 - ABDN series supports 802.11a/b/g/n
- Integrated Airborne Device Server and Wireless Adapter technology.
- Supports WEP, WPA, WPA2 and 802.1x Supplicant, with Certificates.
- The wireless device server includes integrated:
 - 802.11 Radio Driver
 - TCP/IP stack, UDP, telnet, FTP server
 - Data bridging and buffering
 - Command Line Interface
 - Web interface
 - WPA Supplicant
 - DHCP Server (Ethernet Interface)
 - Firewall and Port Forwarding (Ethernet)
 - FTP Server
- Supports flexible antenna selection.
- Operating Temperature (-40°C to 85°C)
- Storage temp (-40°C to 85°C)
- Industry standard wired connections:
 - D-9 Serial connectors (RS232/422/485)
 - RJ-45 (10/100 Ethernet)
- Multiple host interfaces supported:
 - Single and Dual Serial (RS232/422/485) – up to 921K BAUD
 - 10/100 Ethernet
- Integrated standard and wide range (J1455) Power Supply (5-36VDC)
- Power connector options include 2.1mm Barrel Jack, Terminal Block and custom connectors.
- Power Over Ethernet (PoE) using an 802.3af Class 1 PSE device (ABDx-ER-IN5xx8 models)
- Integrated Site Survey mode.
- Advanced Low power modes.
- Rugged mounting options.
- Virtual COM port driver (WinXP, Vista, Win7)
- Worldwide Regulatory Support (FCC, IC, CE)

4.0 Device Types

This manual covers all variations available in the AirborneDirect™ device family. The following section identifies the different types both functional and classification. In most cases the functional types are available in the listed classifications. If you are not certain which type you have or would like clarify the available options please contact B&B Electronics Sales or Technical support.

4.1 Serial

This device supports a single or dual serial port and provides serial to 802.11 bridging. The serial devices can support one or more of the following serial interface types:

- RS232
- RS422
- RS485

Default configuration on all models is RS232, conversion to RS422/485 requires software configuration and in some models jumper setting changes. These are covered in the following sections.

This device allows the connection of a serial port to an 802.11 network.

4.2 Ethernet

The Ethernet adapter provides a wireless interface to an existing Ethernet port (RJ-45). Depending upon the model of device the connection to the Ethernet port of the host is made via a RJ-45 socket or pigtail with a RJ-45 plug.

The device supports a 10/100 Ethernet interface with auto configuration. Manual control of the interface is possible through the web or CLI interface.

4.3 Serial + Ethernet

This device allows for simultaneous connection of Serial and Ethernet ports. Providing the same functionality on each port that is available on the individual devices, it is possible to maintain network based connections to both the Ethernet and Serial ports without compromise of functionality or performance.

Each interface can be configured and operated independently of the others. Connection to the serial port can be made via both the wireless and Ethernet ports supporting redundant network connectivity for high reliability applications.

4.4 Enterprise Class

The enterprise class product provides the best cost vs. performance in the AirborneDirect™ product family. The packaging is compact and designed to fit with non-industrial applications and markets. The product class supports the full industrial operating temperature range and the complete set of functional capabilities of the Airborne™ Device Server and Wireless Adapter technology.

Figure 1 - Enterprise AirborneDirect™ Device



The Enterprise class product range includes devices that support a single serial port and an Ethernet device.

The enterprise class product is ideal for the following application types:

- Medical equipment.
- Point-of-Sale devices.
- CNC/DNC equipment.
- Time clocks.
- Scales.
- Data collection devices.
- Vehicle diagnostics.

The Enterprise Class products require a 5VDC power supply.

4.5 Industrial Class

Developed to support the demands of the industrial and automotive environments, the features of the Industrial Class products offer a more flexible and rugged alternative to the enterprise class devices. The product class supports the full industrial operating temperature range and the complete set of functional capabilities of the Airborne Device Server and Wireless Adapter technology.

Figure 2 - Industrial AirborneDirect™ Device

The family includes a metal enclosure and a wide range power supply capable of exceeding the SAE J1455 power supply requirements.

The enterprise class product is ideal for the following application types:

- CNC/DNC equipment.
- Vehicle diagnostics.
- Telematics.
- Remote monitoring and management.
- Industrial control.

The Industrial class of products includes Ethernet only, Serial only and the dual (Serial+Ethernet) capability. Some models support Power over Ethernet (PoE) when connected to an 802.3af Class 1 PSE device.

5.0 Block Diagram

The following outlines the block diagram for the devices:

Figure 3 - ABDx-ER/SE-DP5xx Block Diagram

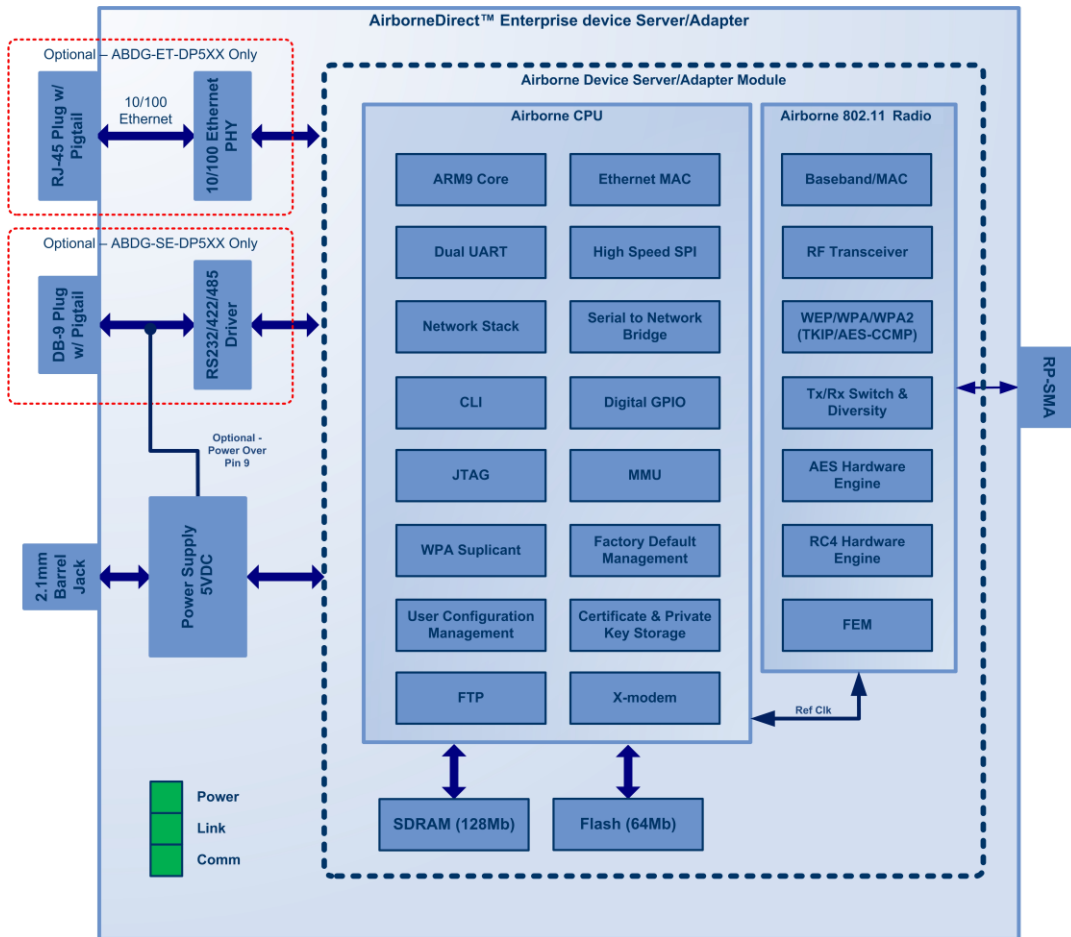
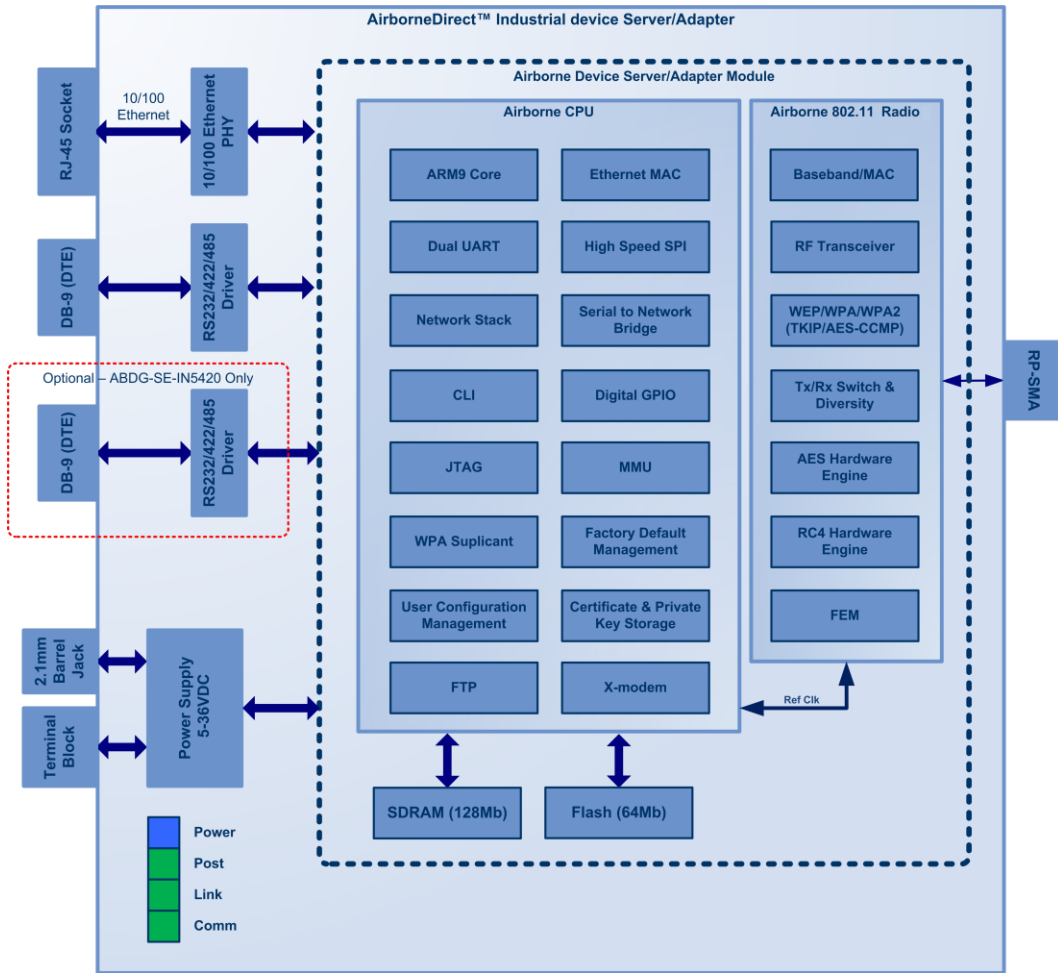

Figure 4 - ABDx-ER/SE-IN5xxx Block Diagram



6.0 Pin out and Connectors

Pin definition is dependent upon the device type selected. The following defines the pin outs for the individual interfaces.

6.1 Serial Ports

The AirborneDirect™ units support either a single or dual serial port configuration. The Port pin out can change depending upon the interface configuration chosen, Table 1 shows the pin out for the interface selected.

Figure 5 - DE-9 (DB-9) Connector Pin-out

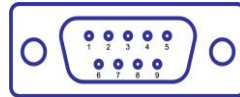

Table 1 – Serial Port Pin Definition

Pin	RS232 (DTE)	RS232 w/ Power on pin 9 ²	RS422	RS485
1	No Connect	No Connect	No Connect	No Connect
2	RxD	RxD	RxD+	Connect to pin 3 ³
3	TxD	TxD	TxD+	TxD+/RxD+
4	No Connect	No Connect	No Connect	No Connect
5	GND	GND	GND	GND
6	No Connect	No Connect	RxD-	Connect to pin 9 ³
7	RTS	RTS	No Connect	No Connect
8	CTS	CTS	No Connect	No Connect
9	No Connect	5VDC (Input)	TxD-	TxD-/RxD-



1. For 2-wire operation, the user must externally connect pin 3 to pin 2 and pin 6 to pin 9.
2. Power on pin 9 only available on Enterprise devices (ABDx-SE-DP501).
3. Only required on Industrial products (ABDx-SE-IN54XX)

Table 2 shows the availability of the serial ports and available interface types by product class.

Table 2 - Serial Ports by Product Class

Device Class	Port 1	Port 2
Enterprise	RS232 RS422 (4-wire) RS485 (2-wire)	N/A
Industrial	RS232 RS422 (4-wire) RS485(2-wire)	N/A
	RS232 RS422 (4-wire) RS485(2-wire)	RS232 RS422 (4-wire)

The Port 1 and Port 2 interfaces support the following configurations:

- BAUD: 300, 600, 1200, 2400, 4800, 9600, 14400, 19200, 28800, 38400, 57600, 115200, 230400, 460800, 921600
- Flow Control: None, Hardware (CTS/RTS), Software (XON/XOFF)
- Port 1 Default settings: 9600, 8, N, 1, No Flow Control.
- Port 2 Default settings: 9600, 8, N, 1, No Flow Control.

6.2 Ethernet Port

The AirborneDirect™ Ethernet devices support a single interface. This is a 10/100Mbps interface that supports auto negotiation and cross-over cabling. The interface also supports both half and full duplex for 10Mbps and 100Mbps. Table 3 shows the interface pin out.

In some Industrial models, the Ethernet port supports Power over Ethernet (PoE) when connected to an 802.3af Class 1 PSE device. Both Mode A (MDI and MDI-X) and Mode B powering schemes are supported (Table 3a).

Figure 6 - Ethernet Jack Pin Out

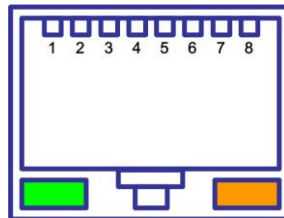

Table 3 - Ethernet Connector Pin Out

Pin	RJ45 Socket (Industrial)	RJ45 Plug (Enterprise)
1	TxD+	RxD+
2	TxD-	RxD-
3	RxD+	TxD+
4	NC	NC
5	NC	NC

Pin	RJ45 Socket (Industrial)	RJ45 Plug (Enterprise)
6	RxD-	TxD-
7	NC	NC
8	NC	NC
Green LED	Valid TCP/IP connection made with Airborne Adapter: Off No TCP/IP connection On Valid TCP/IP Connection	N/A
Yellow LED	Power-on Self Test (POST): Off Not powered or has failed POST On Passed POST	N/A

Table 3a - PoE Pinout Alternatives

Pin	Alternate A (MDI-X)	Alternate A (MDI)	Alternate B (All)
1	Negative V_{PSE}	Positive V_{PSE}	
2	Negative V_{PSE}	Positive V_{PSE}	
3	Positive V_{PSE}	Negative V_{PSE}	
4			Positive V_{PSE}
5			Positive V_{PSE}
6	Positive V_{PSE}	Negative V_{PSE}	
7			Negative V_{PSE}
8			Negative V_{PSE}

6.3 Connector Definition

There are a total of five connectors used by the AirborneDirect™ family. Which connectors are available on your product depend upon the model you purchased. The definition for the connectors is common to all product classes. Table 4 provides definitions for the connectors.

Table 4 - Connector Description

Type	Description	Product Class
Serial	DE-9 Connector Male	Enterprise, Industrial
Ethernet	RJ45 Plug	Enterprise
Ethernet	RJ45 Socket	Industrial
Antenna	RP-SMA	Enterprise, Industrial
Power	2.1mm Barrel Jack	Enterprise, Industrial
Power	2 Position Terminal Block	Industrial

6.4 OEM Reset Switch (Factory Reset)

All AirborneDirect™ devices support the ability to reset the configuration back to OEM defaults. This is useful when a device has been incorrectly configured and has lost the ability to communicate on any of the available ports, preventing access to one of the configuration interfaces and blocking your ability to recover the device by correcting the configuration.

The following Table 5 describes the sequence for OEM resetting the AirborneDirect™ devices. All devices use the same process however the location of the OEM reset switch varies between the product families.

Table 5 - OEM Reset Procedure

1	Disconnect or turn off the power supply.
2	Press the OEM reset (factory reset) button. This may require the use of a small narrow object, it is important that this object is not sharp as it may cause damage to the unit.
3	While holding the OEM button pressed reapply power to the unit.
4	Hold the OEM reset button for 5-6 seconds after power has been applied.
5	Release the OEM reset button.
6	The device will restart with the installed OEM defaults. If no OEM Configuration is applied the device will return to B&B Electronics factory defaults. See section 15.6 on use of OEM factory configurations.

The location of the OEM reset button for the Enterprise devices is on the back of the enclosure, underneath the label near the pigtail. The Industrial devices OEM reset button is on the Ethernet/Power end of the box next to the 2.1mm barrel connector (See section 10.0)

6.5 Enterprise Serial Interface Jumpers

The Enterprise Serial device server supports RS232/422/485 interface drivers, as well as power over pin 9. Selection of these options is made through both the web interface and hardware jumpers. Figure 7 shows the interface selection jumpers for the different interface types.

Figure 7- Interface Selection Jumpers

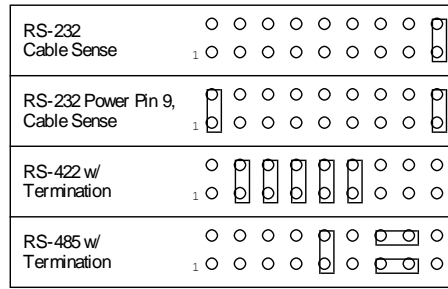

The jumper selections must be made while the device is unpowered and before being used in the final application.



The interface type selected by the interface jumpers in Figure 7 must match the selected configuration for the **Configuration | Serial Port Settings | Serial Interface Type** setting in the web interface.

6.6 Indicator LED's

The devices provide indicator LED's to provide feedback on the state of the device. These are a useful tool during installation and troubleshooting.

Table 6 - Enterprise LED Indicators

LED	Color	Airborne Device State
POWER	○	Adapter is not powered.
	●	Adapter failed Power On Self Test (POST) and is not configured for wireless communication.
	●	Adapter passed POST but is not configured for wireless network communication.
	●	Adapter passed post and is configured for wireless communication.
LINK	○	Adapter is not powered.
	☀	(Periodic Blinking) Adapter is searching for a valid network (Access Point) that matches device's configuration.
	●	Adapter has successfully associated with an Access Point.
COMM	○	If Power LED is also Off then Adapter is not powered. If Power LED is On then either: <ul style="list-style-type: none"> A physical connection detected on Serial/Ethernet cable. No TCP session from wireless interface has been established.
	●	No physical Serial/Ethernet connection has been detected.















LED	Color	Airborne Device State
		(Blinking – OFF/Red) A physical Serial/Ethernet connection has been detected and there is traffic across the interface. No TCP connection to the adapter has been established on the wireless interface.
		A TCP connection to the adapter from the wireless interface has been established but no physical connection on the Serial/Ethernet interface has been detected.
		(Blinking – Green/Orange) A physical Serial/Ethernet connection has been detected and there is Serial/Ethernet traffic across the interface. A TCP connection to the adapter has been established (On WLAN or Ethernet interface).
		A physical Serial/Ethernet connection has been detected. A TCP connection to the adapter has been established from the WLAN or Ethernet interface but no traffic has been detected.

Table 7 - Industrial LED Indicators

LED	Color	Airborne Device State
POWER		Adapter is not powered.
		Adapter is powered.
POST		Adapter is not powered.
		Adapter failed Power On Self Test (POST) and is not configured for wireless communication.
		Adapter passed POST but is not configured for wireless network communication.
		Adapter passed post and is configured for wireless communication.
LINK		Adapter is not powered.
		(Periodic Blinking) Adapter is searching for a valid network (Access Point) that matches device's configuration.
		Adapter has successfully associated with an Access Point.
COMM		If Power LED is also Off then Adapter is not powered. If Power LED is On then: <ul style="list-style-type: none"> No TCP session from WLAN or Ethernet interface has been established.
		A TCP connection to the adapter has been established from the Wireless or Ethernet interfaces but no traffic has been detected.

7.0 Electrical & RF Specification

Table 8- Absolute Maximum Values¹

Parameter	Min	Max	Unit
Maximum Supply Voltage - Enterprise	4.5	5.5	VDC
Maximum Supply Voltage - Industrial	5.0	36	VDC
PoE 802.3af Class1 – Industrial (IN5xx8 models)	37	57	VDC
Power Dissipation		3.00	W
Operating Temperature Range	-40	85	°C
Storage Temperature	-40	85	°C

Note: 1. Values are absolute ratings, exceeding these values may cause permanent damage to the device.

Table 9 - RF Characteristics – 802.11a/b/g/n

Symbol	Parameter	Rate (Mb/s)	Min	Average dBm / mW		Peak dBm / mW		Units
P _{OUTB}	Transmit Power Output 802.11b	11, 5.5, 2, 1		15.0	31.6			dBm
P _{OUTG}	Transmit Power Output 802.11g	6, 9, 12, 18, 24, 36, 48, 54		12.6	18.2			dBm
P _{OUTA}	Transmit Power Output 802.11a	6, 9, 12, 18, 24, 36, 48, 54		17.0	50.1			dBm
P _{RSENB}	Receive Sensitivity 802.11b	11		-86				dBm
		1		-92				
P _{RSENG}	Receive Sensitivity 802.11g	54		-72				dBm
		36		-78				
		18		-84				
		6		-89				
P _{RSENA}	Receive Sensitivity 802.11a	54		-74				dBm
		36		-80				
		18		-86				
		6		-90				
F _{RANGE BG}	Frequency Range		2412			2484		MHz
F _{RANGE A}	Frequency Range 802.11a		4910 5150 5470			4990 5350 5825		MHz



The transmit power is automatically controlled by the device for minimum power consumption.

The transmit power at the antenna connector is listed in Table 9 above (±2dBm)..

Table 10 - Supported Data Rates by Band

Band	Supported Data Rates (Mb/s)
802.11b	11, 5.5, 2, 1
802.11a/g	54, 48, 36, 24, 18, 12, 9, 6
802.11n	65, 58.5, 42, 39, 26, 19.5, 13, 6.5

Table 11 - Operating Channels

Band	Region	Freq Range (GHz)	No. of Channels	Channels
802.11b ^{1,2}	US/Canada	2.401 - 2.473	11	1 – 11
	Europe	2.401 - 2.483	13	1 – 13
	Japan	2.401 - 2.495	14	1 – 14
802.11g ^{1,2}	US/Canada	2.401 - 2.473	11	1 – 11
	Europe	2.401 - 2.483	13	1 – 13
	Japan	2.401 - 2.483	13	1 – 13
802.11a ³	US/Canada	5.15 - 5.35, 5.725 - 5.825	13	36,40,44,48,52,56,60,64,149,153,157, 161,165
	Europe	5.15 - 5.35, 5.47 - 5.725	19	36,40,44,48,52,56,60,64,100,104,108, 112,116,120,124,128,132,136,140
	Japan	4.91 – 4.99, 5.15 - 5.35, 5.47 - 5.725	23	36,40,44,48,52,56,60,64,100,104,108, 112,116,120,124,128,132,136,140,184, 188,192,196
	China	5.725 - 5.825	5	149,153,157,161,165



1. Only channels 1, 6 and 11 are non-overlapping.
2. Channel 14 is non-overlapping (Japan only).
3. Channel count denotes number of non-overlapping channels. Channels shown represent non-overlapping channel numbers.

7.1 AC Electrical Characteristics – Transmitter

Transmit power is automatically managed by the device for minimum power consumption. The transmit power at the RF connector is listed in Table 9 for 802.11a/b/g Modes (all rates).

7.2 Performance/Range

The following table illustrates the typical data rates, performance and range the device is capable of providing using an omni-directional antenna.

Table 12 - Radio Typical Performance Range

Data Rate	Typical Outdoor Distance (Unity gain antenna)	Typical Outdoor Distance (2dBi antenna gain on each end for B/G mode)
1.0 Mb/s	240m	380m
11.0 Mb/s	135m	215m
6Mb/s 802.11g	135m	215m
6Mb/s 802.11a	49m	155m
54Mb/s 802.11g	12m	19m
54Mb/s 802.11a	4.5m	14m

Ranges are affected by receiver sensitivity; transmit power, free-space path loss, antenna gain, and link margin. Actual range will vary from those stated. Non-line-of-site applications will result in typical values less than shown above.

The Data Rate is the supported connection rate for the wireless link, the actual data throughput for the link will be less than the stated data rates.

8.0 Antenna

The unit supports antenna connection through a single Hirose U.FL connector, located on the top surface of the radio next to the RF shielding.

Any antenna used with the system must be designed for operation within the 2.4GHz ISM band and specifically must support the 2.412GHz to 2.482GHz for 802.11b/g, the 5GHz ISM band and must specifically support 5.1GHz to 5.9GHz for 802.11a operation. They are required to have a VSWR of 2:1 maximum referenced to a 50Ω system impedance.

8.1 Antenna Selection

The Airborne radio supports a number of antenna options, all of which require connection to the U.FL connectors on the radio. Ultimately the antenna option selected will be determined by a number of factors, including consideration of the application, mechanical construction and desired performance. Since the number of possible combinations is endless we will review some of the more common solutions in this section. If your application is not covered during this discussion please contact Technical Support for more specific answers.

The available antenna connections include:

- Host board mounted antenna
- Host Chassis mounted antenna
- Embedded antenna

In addition to the above options, location and performance need to be considered. The following sections discuss these items.

8.2 Host Board Mounted Antenna

Host board mounted requires that an antenna connection is physically mounted to the host system board. It also requires that the host board include a U.FL connector to allow a U.FL to U.FL coaxial lead to connect from the radio to the host board. It will then require 50Ω matched PCB traces to be routed from the U.FL connector to the antenna mount.

There are several sources for the U.FL to U.FL coaxial cable these include Hirose, Sunridge and IPEX. Please contact B&B Electronics for further part numbers and supply assistance.

This approach can simplify assembly but does require that the host system configuration can accommodate an antenna location that is determined by the host PCB. There are also limitations on the ability to seal the enclosure when using this approach.

This approach also restricts the selection of available antenna. When using this approach, antennas that screw or press fit to the PCB mount connector must be used. There are many options for the antenna connector type, however if you

wish to utilize the FCC/IC modular approval the connector choice must comply with FCC regulations. These state that a non-standard connector, e.g. RP-TNC/RP-SMA, is required. TNC/SMA connectors are not allowed.

8.3 Host Chassis Mounted Antenna

Host Chassis mounted antennas require no work on the host PCB. They utilize an antenna type called 'flying lead'. There are two types of flying leads; one which provides a bulkhead mounted antenna connector and one which provides a bulk head mounted antenna. The type you choose will be determined by the application.

A flying lead system connects a U.FL coaxial lead to the radio's U.FL connector. The other end of the coax is attached to either a bulkhead mounted antenna connector or directly to an antenna that has an integrated bulkhead mount.

In either of the two cases, the use of this approach significantly reduces the antenna system development effort and provides for greater flexibility in the available antenna types and placement in the host system chassis.

When using the flying lead antenna (integrated bulk head mounting), there are no connector choice restrictions for use with the FCC/IC modular certification. However if the flying lead connector is used, the same restrictions as identified for the Host Mounted Antenna apply.

There are many suppliers of flying lead antenna and connectors. B&B Electronics' Airborne Antenna product line offers a range of antenna solutions.

8.4 Embedded Antenna

Use of Embedded antenna can be the most interesting approach for M2M, industrial and medical applications. Their small form factor and absence of any external mounting provides a very compelling argument for their use. There is a downside to this antenna type and it comes with performance. Antenna performance for all of the embedded options will, in most cases, be less than that achievable with external antenna. This does not make them unusable; it will impact choice of antenna type and requires more focus on placement.

The three main embedded antenna types are PCB embedded, chip (PCB mounted) and flying lead; each has its advantages and disadvantages (See Table 13).

Table 13 - Embedded Antenna Options

Antenna Type	Features			
	Cost	Size	Availability	Performance
PCB Embedded	Lowest	Largest	Custom	Poor
Chip	Low	Small	Standard	Poor
Flying Lead	Low	Small	Standard	Fair

PCB Embedded – This approach embeds an antenna design into the host PCB. This approach is very common with add-in WiFi cards (CF, PCMCIA, SDIO, etc.) as it requires no external connections and is the cheapest production approach. The lower production cost requires significant development cost and lack of performance and flexibility.

Chip – The integration of a chip antenna is simple and requires a relatively small footprint on the host system, however, it does suffer from the same limitations of flexibility and performance seen with the PCB embedded approach. There are relatively large numbers of suppliers of this type of antenna; there is also a range of configuration and performance options.

Flying Lead – This approach is similar to the flying lead solution for external antennas. The difference is that the form factors are smaller and provide a range of chassis and board mounting options, all for internal use. This approach suffers less from the performance and flexibility limitations of the other approaches, since the location of the antenna is not determined by the host PCB design. The assembly of a system using this approach maybe slightly more complex since the antenna is not necessarily mounted on the host PCBA.

8.5 Antenna Location

The importance of this design choice cannot be over stressed. It can in fact be the determining factor between success and failure of the WiFi implementation.

There are several factors that need to be considered when determining location:

- Distance of Antenna from radio
- Location of host system
 - Proximity to RF blocking or absorbing materials
 - Proximity to potential noise or interference
 - Position relative to infrastructure (Access Points or Laptops)
- Orientation of host system relative to infrastructure
 - Is it known
 - Is it static

To minimize the impact of the factors above the following things need to be considered during the development process:

- Minimize the distance between the radio and the location of the antenna. The coaxial cable between the two impacts the Transmit Power and Receive Sensitivity negatively. B&B Electronics recommends using 1.32-1.37mm outer diameter U.FL coaxial cables.
- Minimize the locations where metal surfaces come into contact or are close to the location of the antenna.
- Avoid locations where RF noise, close to or over lapping the ISM bands, may occur. This would include microwave ovens and wireless telephone systems in the 2.4GHz and 5.0GHz frequency range.
- Mount the antenna as high on the equipment as possible.

- Locate the antenna where there is a minimum of obstruction between the antenna and the location of the Access Points. Typically Access Points are located in the ceiling or high on walls.
- Keep the main antenna's polarization vertical, or in-line with the antenna of the Access Points. 802.11 systems utilize vertical polarization and aligning both transmit and receive antenna maximizes the link quality.

Even addressing all of the above factors does not guarantee a perfect connection, however with experimentation an understanding of the best combination will allow a preferred combination to be identified.

8.6 Performance

Performance is difficult to define as the appropriate metric changes with each application or may indeed be a combination of parameters and application requirements. The underlying characteristic that, in most cases, needs to be observed is the link quality. This can be defined as the bandwidth available over which communication between the two devices can be performed. The lower the link quality the less likely the devices can communicate.

Measurement of link quality can be made in several ways: Bit Error Rate (BER), Signal to Noise (SNR) ratio, Signal Strength, and may also include the addition of distortion. The link quality is used by the radio to determine the link rate. Generally as the link quality for a given link rate drops below a predefined limit, the radio will drop to the next lowest link rate and try to communicate using it.

The reciprocal is also true. If the radio observes good link quality at one rate it will try to move up to the next rate to see if communication can be sustained using it. It is important to note that for a given position the link quality improves as the link rate is reduced. This is because as the link rate drops the radios Transmit power and Receive sensitivity improve.

From this it can be seen that looking at the link rate is an indirect way of assessing the quality of the link between the device and an Access Point. You should strive to make the communication quality as good as possible in order to support the best link rate. However be careful not to *over specify* the link rate. Consider your application's bandwidth requirements and tailor your link rate to optimize the link quality. For example, the link quality for a location at 6Mb/s is better than it would be for 54Mb/s. If the application only needs 2Mb/s of data throughput, the 6Mb/s rate would provide a better link quality.

Aside from the radio performance, there are a number of other things that contribute to the link quality. These include the items discussed earlier and choices made when looking at the overall antenna gain. The antenna gain contributes to the Equivalent Isotropically Radiated Power (EIRP) of the system. This is part of an overall measurement of the link quality called link margin.

Link Margin provides a measure of all the parts of the RF path that impact the ability of two systems to communicate. The basic equation looks like this:

$$\text{EIRP (dB)} = \text{TxP} + \text{TxA} - \text{TxC}$$

$$\text{Link Margin (dB)} = \text{EIRP} - \text{FPL} + (\text{RxS} + \text{RxA} - \text{RxC})$$

Where:

- TxP = Transmitter output power (dBm)
- TxA = Transmitter antenna gain (dBi)
- TxC = Transmitter to Antenna coax cable loss (dB)
- FPL = Free Path Loss (dB)
- RxS = Receiver receive sensitivity (dBm)
- RxA = Receiver antenna gain (dBi)
- RxC = Receiver to Antenna coax cable loss (dB)

This is a complex subject and requires more information than is presented here, B&B Electronics recommends at reviewing the subject and evaluating any system at a basic level.

It is then possible, with a combination of the above items and an understanding of the application demands, to achieve a link quality optimized for the application and host design. It is important to note that this is established with a combination of hardware selection, design choices and configuration of the radio.

9.0 Mechanical Outline – Enterprise Class

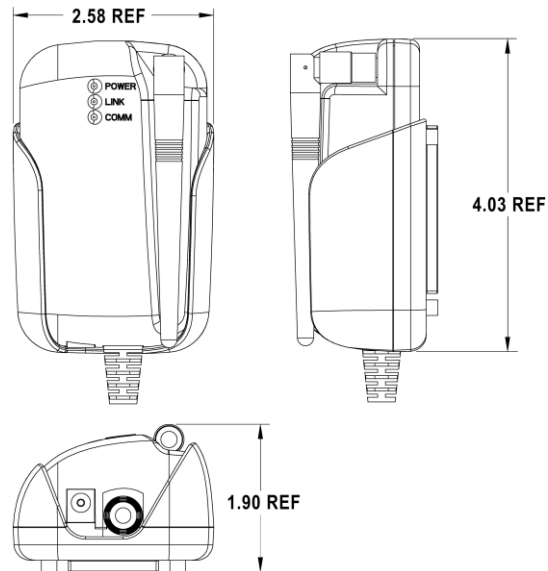

- Antenna Connector: **RP-SMA (Reverse Polarity – SMA)**
Requires 2.4GHz/5GHz ISM band antenna, 50 input impedance, RP-SMA connector
- Serial Connector: **DB-9M (Male)**
Requires DB-9 (Female)
- Ethernet Connector: **RJ-45 Plug**
Requires RJ-45 socket, 10/100 Ethernet interface
- Power Connector: **2.1mm Barrel Jack**
Requires 2.1mm ID, 5.5mm OD, +5VDC center pin.

10.0 Mechanical Outline – Industrial Class

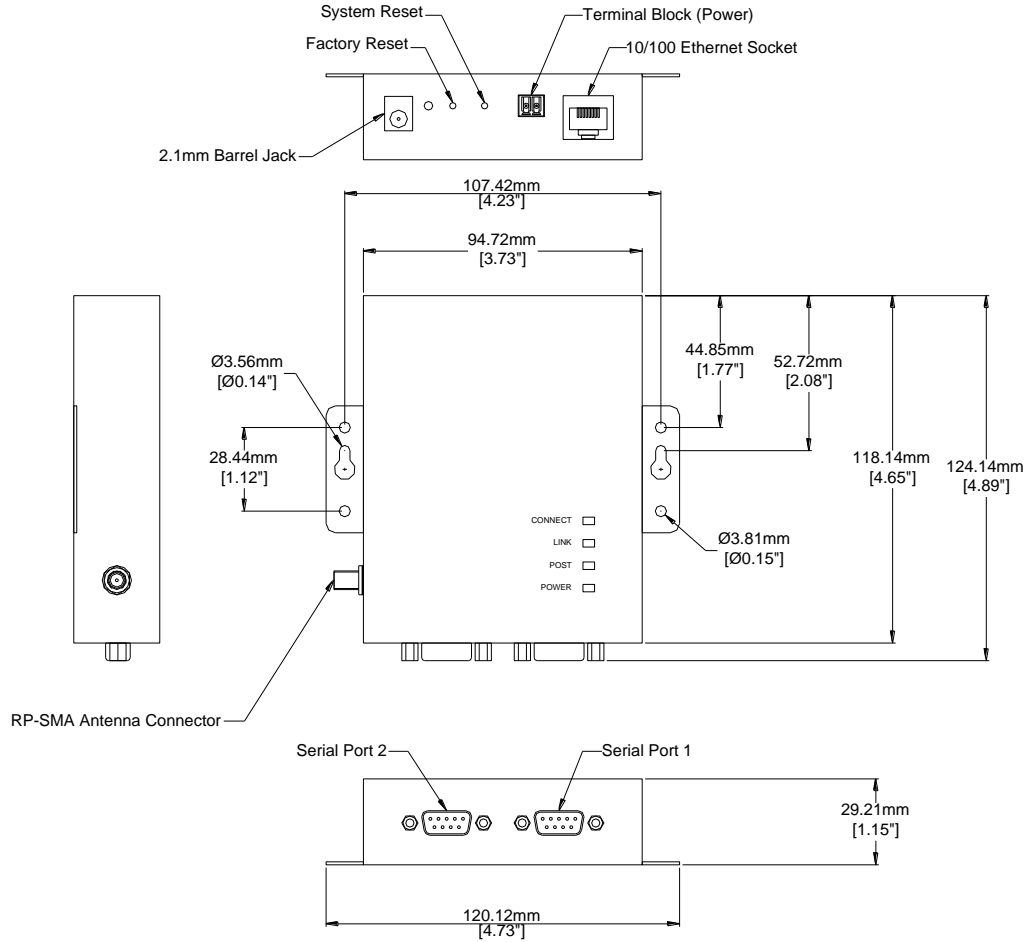

- Antenna Connector: **RP-SMA (Reverse Polarity – SMA)**
Requires 2.4GHz/5GHz ISM band antenna, 50 input impedance, RP-SMA connector
- Serial Connector: **DB-9M (Male)**
Requires DB-9F (Female)
- Ethernet Connector: **RJ-45 Socket**
Requires RJ-45 plug, 10/100 Ethernet interface
- Power Connector: **2.1mm Barrel Jack**
Requires 2.1mm ID, 5.5mm OD, +5VDC center pin.
- Power Connector: **Terminal Block (2 connector)**
Requires 16-30 AWG gauge wire.

11.0 Getting Started

11.1 Unpack the AirborneDirect™ Device

Unpack the AirborneDirect™ Device and compare the package contents with the items listed on the front of the included Quick Start Guide. If any item is missing or damaged, contact B&B Electronics immediately.

Contact details can be found at www.B&B Electronics.com/support.

11.2 Connect AirborneDirect™ to host

Connect the Airborne Direct unit to a system capable of configuring it. The preferred initial connection depends upon the class and type of product:

Serial – Enterprise: Connect to a serial port on the host or through a serial to USB adapter.

Serial – Industrial: Connect the RJ-45 socket to a RJ-45 socket using a CAT 5 Ethernet cable.

Ethernet – Enterprise: Connect to an RJ-45 socket on the host.

Ethernet – Industrial: Connect the RJ-45 socket to a RJ-45 socket using a CAT 5 Ethernet cable.

11.3 Attach Antenna and Power-up the AirborneDirect™

Attach the supplied antenna to the RP-SMA connector on the AirborneDirect™ unit. Connect the supplied AC adapter to the power connector. If using your own power supply make sure the correct power connector type and polarity are being used, verify the appropriate voltage to be applied by checking Table 8 for the correct product class. Confirm that the device is receiving power by verifying that the POST LED is lit when the supply is applied.

12.0 Configuring Device – Industrial Serial (ABDx-SE-IN5xxx)

The following describes initial connection to an AirborneDirect™ Serial Device Server (ABDx-SE-IN5xxx). If you have an Ethernet device (ABDx-ER-DP5xx/IN5xxx), please go to section 14.0. If you have purchased a SE-DP5xx device please go to section 13.0 for the set-up instructions.

The instructions in Table 14 provide step-by-step instructions for configuration of the ABDx-SE-IN5xxx product family.

Table 14 - SE-IN5xxx Accessing the Web Interface

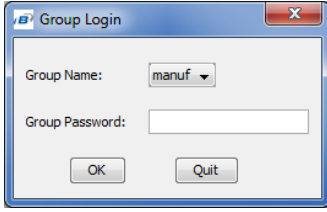
1	Open the AirborneDirect™ packaging and locate the Install CD.
2	Place the CD in the CD/DVD drive of the laptop or desktop you will be using to configure the AirborneDirect™ device. Follow the on screen directions for installation of the appropriate device software and documentation.
3	Connect the Ethernet cable on ABDx to an Ethernet port on the laptop or desktop system.
4	Apply power to the ABDx-SE-IN5xxx.
5	<p>The unit will boot and display one of the following LED patterns:</p> <p>ABDx-SE-IN5xxx</p> <p>COMM: ● Off</p> <p>LINK : ● Red</p> <p>POST: ● Orange</p> <p>POWER: ● Blue</p>
6	<p>Run the Airborne Management System application. This was installed during the CD installation and a menu item will be found in the Airborne folder located in the programs directory of your system.</p> <p>When the application opens the following dialog will be displayed:</p>  <p>Select Group Name: manuf and enter Group Password: dpac</p>

7

The AMC will load and discover the attached device.

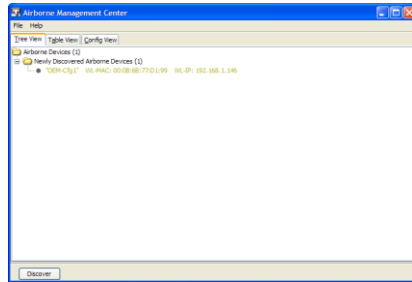

 If the unit is not detected please verify that your firewall is disabled. Run a "Discover", if the unit is still not being detected, close down AMC and restart it by doing a Right Click on the AMC icon and select "Run as administrator".

8

Manage Your Device

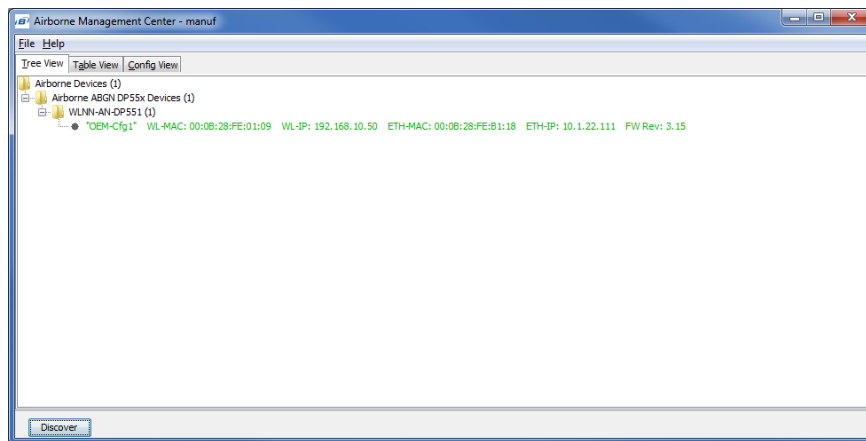
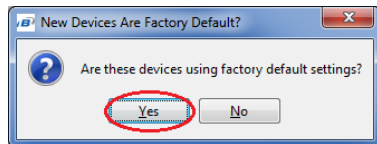
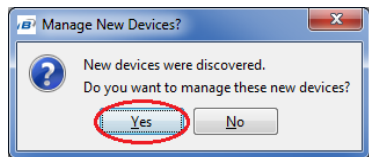

9

The devices status will move to managed and the device will be displayed under the device type/group it belongs too. Right click the device and then:

1. Select **Connectivity Tools**
2. Select **Launch Web Browser for OEM-Cfg1**

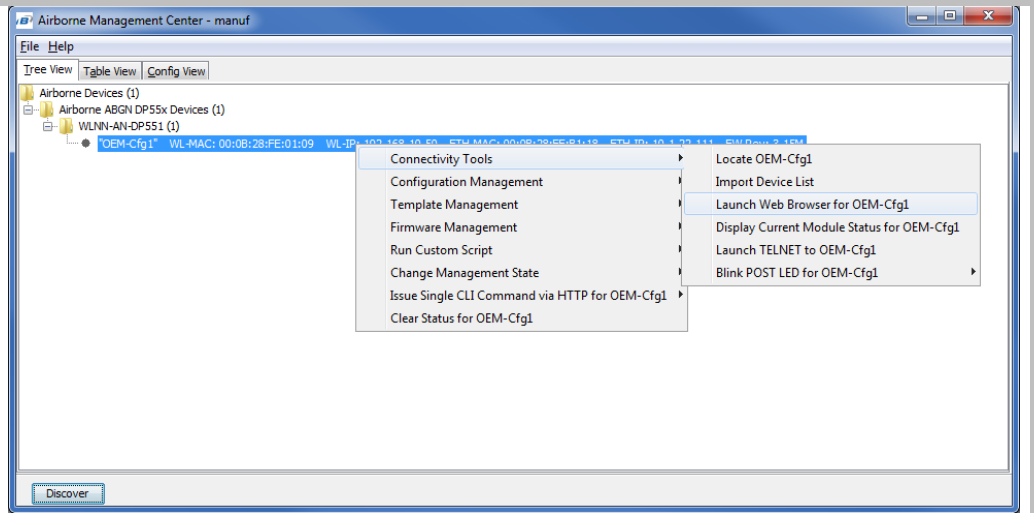

Username= "dpac"
 Password = "dpac"

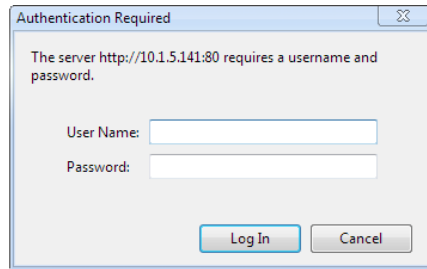

- 10

Opening web page shows adapter status.

Links to the available configuration options are identified in the left hand menu. The top menu bar provides access to different operations that can be performed by the AirborneDirect™ device. See section 15.0 for a full description of how to use the web interface.
- 11

Using Express Setup:

If this is the first time you have configured the device the Express Setup page will be displayed, please refer to section 16.0 to continue set-up of the device.

If this is not the first time please move to section to update the configuration
- 12

When the **Reboot** button is pressed the unit will restart and install new settings. This may take 15-20 seconds. Please refresh the web interface after the boot cycle has completed.
- 13

When configured correctly the LED pattern should match the following:

ABDx-SE-IN5xxx	<i>No TCP Connection</i>	<i>TCP Connection</i>
COMM:	● Off	● Green
LINK :	● Green	● Green
POST:	● Green	● Green
POWER:	● Blue	● Blue
- 14

To use the adapter on the wireless network, address all traffic to the IP address of the wireless interface of the ABDx-SE- IN5xxx. This address is listed in the home page of the web interface.

13.0 Configuring Device – Enterprise Serial (ABDx-SE-DP5xx)

The ABDx-SE-DP5xx family does not have an Ethernet port for initial configuration so initial configuration can be performed through the serial port. To do this it is necessary to connect using the serial connector.

13.1 Connect a Host Computer

Connect the serial pigtail connector to the serial port on a host computer.



It may be necessary to use a gender changed that includes a Null Modem adapter.

13.2 Interacting with the AirborneDirect™ device

On the Host computer, use a terminal emulation program to interact with the device issuing B&B Electronics Command Line Interface (CLI) commands. CLI commands let you request status or change parameter settings. Press the Enter key (<CR>) after each command line you type. After the module starts, type the following CLI command to log in (you must log in before CLI commands can be recognized):

Table 15 - UART Authentication

CLI Command	Description
Send Break Sequence	The serial port starts up in a listen mode waiting for a request for a data tunnel. To access the CLI mode in which set-up can take place the break sequence must be sent. The default break sequence for the device is $\tilde{\sim}$ ABD The sequence must be sent with no trailing characters. If received correctly the device will respond OK.
auth dpac dpac <CR>	The module responds with OK, indicating that it executed the command successfully. (If you did not receive OK, check the settings in your terminal emulation program).



You will have to break into CLI mode and log into the module after any reset or restart.

13.3 Determine and Store the Access Point SSID

On the Host computer, use the terminal emulation program to type the following CLI commands in the order shown:

Table 16 - UART SSID & Authentication

CLI Command	Description
<code>wl-scan<CR></code>	The module scans for APs and returns information on each one it discovers. Note the SSID value that is returned, as you will need to enter it when configuring the device in the next steps.
<code>wl-ssid [SSID]<CR></code>	Associates the module with the network name [SSID] you specify. [SSID] is the value returned by the <code>wl-scan</code> command.
<code>commit<CR></code>	Stores the information to flash memory.
<code>restart</code>	Restarts the device and installs the new settings.

If your access point has security enabled, you will also need to use the CLI to enter those parameters (See the Enterprise CLI Reference Guide for details). That setup is outside the scope of this user guide, which assumes that the AP being tested with has no security.

After issuing the commands, the unit will restart and apply the network settings. Once restarted the LINK LED will stop blinking and go solid. If DHCP is enabled on the network the POWER and LINK LED's will turn solid green.

13.4 Determine the Device's IP address

On the Host computer, use the terminal emulation program to type the following CLI commands:

Table 17 - UART Determine Module's IP Address

CLI Command	Description
Send Break Sequence	The serial port starts up in a listen mode waiting for a request for a data tunnel. To access the CLI mode in which set-up can take place the break sequence must be sent. The default break sequence for the device is <code>~ABD</code> The sequence must be sent with no trailing characters. If received correctly the device will respond <code>OK</code> .
<code>auth dpac dpac <CR></code>	Authenticate with the device server.
<code>wl-ip<CR></code>	The module returns the IP address assigned to it by the DHCP server.

13.5 Accessing the Device Using the Web Interface

See section 15.0.

13.6 Accessing the Device Using Telnet

On the Remote computer, use a terminal emulation program to start a Telnet session. To connect to the device using TCP/IP, use the IP address obtained in section 13.4 to connect on port 23.

The terminal emulator will attempt to connect to the IP address; if successful you will now be able to use the WLAN interface for configuration of the device through either CLI or web.

For more information on the full CLI command set please refer to the Airborne Enterprise Command Line Reference Manual.



The above process can be achieved by any of the available Terminal Emulation programs. Please follow the specific applications requirements to make the TCP/IP connection and authenticate with the module.

14.0 Configuring Device – Enterprise/Industrial Ethernet (ABDx-ER-DP5xx/IN5xxx)

The following instructions describe how access the AirborneDirect™ Ethernet device and web interface for initial configuration of the unit.

Table 18 – ER-DP5xx/IN5xxx Accessing the Web Interface

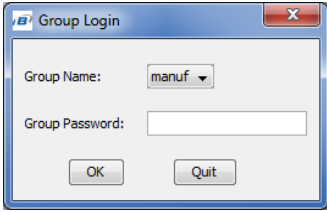
1	Open the AirborneDirect™ packaging and locate the Install CD.																											
2	Place the CD in the CD/DVD drive of the laptop or desktop you will be using to configure the AirborneDirect™ device. Follow the on screen directions for installation of the appropriate device software and documentation.																											
3	Connect the Ethernet cable on ABDx to an Ethernet port on the laptop or desktop system.																											
4	Apply power to the ABDx-ER-DP5xx/IN5xxx.																											
5	<p>The unit will boot and display one of the following LED patterns:</p> <table border="0"> <tr> <td style="vertical-align: top;">ABDx-ER-DP5xx</td> <td style="vertical-align: top;"><i>Associated (Open Network)</i></td> <td style="vertical-align: top;"><i>Not Associated</i></td> </tr> <tr> <td>POWER:</td> <td>● Green</td> <td>● Green</td> </tr> <tr> <td>LINK :</td> <td>● Green</td> <td>● Red (Periodic Blinking)</td> </tr> <tr> <td>COMM:</td> <td>● Red</td> <td>● Red</td> </tr> <tr> <td>ABDx-ER-IN5xxx</td> <td></td> <td></td> </tr> <tr> <td>COMM:</td> <td>● Off</td> <td></td> </tr> <tr> <td>LINK :</td> <td>● Off</td> <td></td> </tr> <tr> <td>POST:</td> <td>● Orange</td> <td></td> </tr> <tr> <td>POWER:</td> <td>● Blue</td> <td></td> </tr> </table>	ABDx-ER-DP5xx	<i>Associated (Open Network)</i>	<i>Not Associated</i>	POWER:	● Green	● Green	LINK :	● Green	● Red (Periodic Blinking)	COMM:	● Red	● Red	ABDx-ER-IN5xxx			COMM:	● Off		LINK :	● Off		POST:	● Orange		POWER:	● Blue	
ABDx-ER-DP5xx	<i>Associated (Open Network)</i>	<i>Not Associated</i>																										
POWER:	● Green	● Green																										
LINK :	● Green	● Red (Periodic Blinking)																										
COMM:	● Red	● Red																										
ABDx-ER-IN5xxx																												
COMM:	● Off																											
LINK :	● Off																											
POST:	● Orange																											
POWER:	● Blue																											
6	<p>Run the Airborne Management System application. This was installed during the CD installation and a menu item will be found in the Airborne folder located in the programs directory of your system.</p> <p>When the application opens the following dialog will be displayed:</p>  <p>Select Group Name: manuf and enter Group Password: dpac</p>																											

7

The AMC will load and discover the attached device.

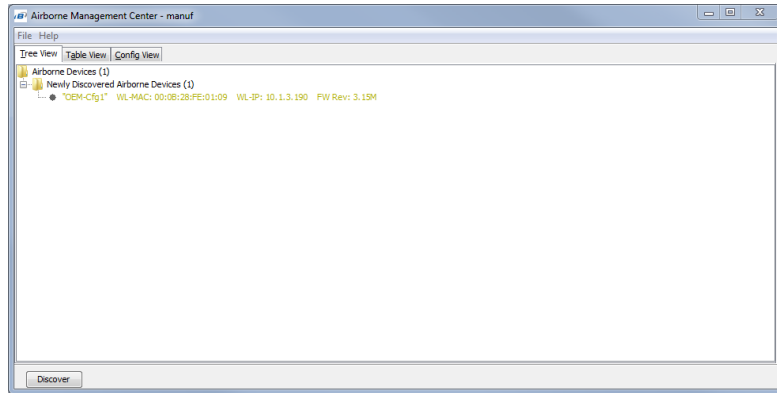

If the unit is not detected please verify that your firewall is disabled. Run a "Discover", if the unit is still not being detected, close down AMC and restart it by doing a Right Click on the AMC icon and select "Run as administrator".

8

Manage Your Device

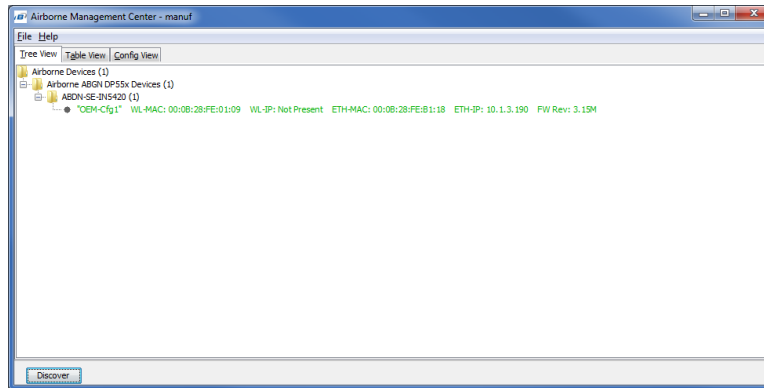
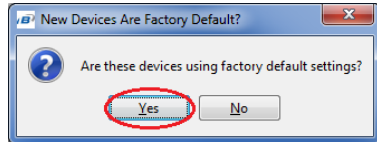
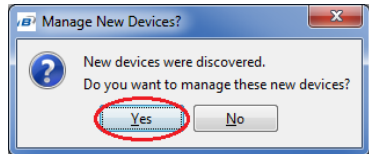

9

The devices status will move to managed and the device will be displayed under the device type/group it belongs too. Right click the device and then:

3. Select **Connectivity Tools**
4. Select **Launch Web Browser for OEM-Cfg1**

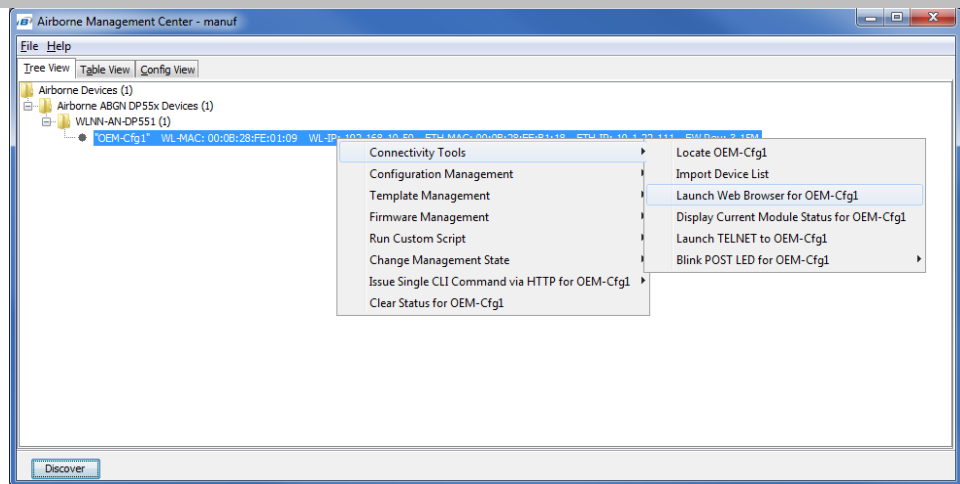

Username= "dpac"
 Password = "dpac"

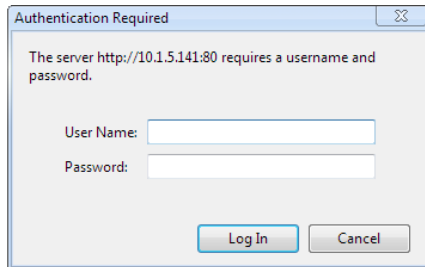

10 Opening web page shows adapter status.
 Links to the available configuration options are identified in the left hand menu. The top menu bar provides access to different operations that can be performed by the AirborneDirect™ device. See section 15.0 for a full description of how to use the web interface.

11 Using Express Setup:
 If this is the first time you have configured the device the Express Setup page will be displayed, please refer to section 16.0 to continue set-up of the device.
 If this is not the first time please move to section to update the configuration

12 When the **Reboot** button is pressed the unit will restart and install new settings. This may take 15-20 seconds. Please refresh the web interface after the boot cycle has completed.

13 When configured correctly the LED pattern should match the following:

ABDx-ER-DP5xx		
POWER:	● Green	
LINK :	● Green	
COMM:	● Red	
ABDx-ER-IN5xxx		
COMM:	● Off	TCP Connection
LINK :	● Green	● Green
POST:	● Green	● Green
POWER:	● Blue	● Blue

14 To use the adapter on the wireless network, address all traffic to the IP address of the wireless interface of the ABDx-ER-DP5xx/IN5xxx. This address is listed in the home page of the web interface.

15.0 Using the Web Interface

The AirborneDirect™ Device Servers and Wireless Adapters include a web interface that provides access to module status, parameter modification and certificate and configuration file management. To use the web interface follow the steps outlined in section 14.0 to establish the IP address of the module. Once the IP address is known open a web browser and enter the IP address of the module in the URL window.

The web interface currently supports Internet Explorer v6.0 thru 9.0, Firefox v3.x+, Opera v9.6+, Chrome v4.0+ and Safari v5.0.5+.

When the authentication request is returned enter:

Figure 8 - Website Login

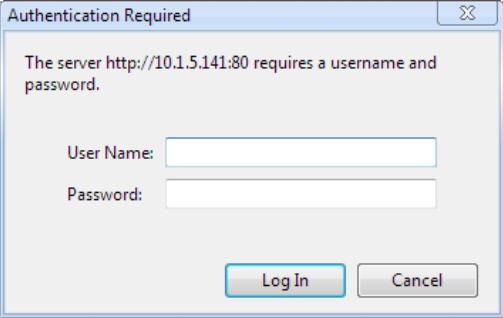

Username: dpac
Password: dpac

After successfully authenticating with the module, you will be logged into the web server. If this is the first time you have accessed the device the Express Setup page will be displayed see section 16.0 for configuration of the device using this page. If you have previously configured the device the default home page will be displayed (See Figure 9), from here you can update device settings if required. A quick overview of the web interface follows.

Figure 9 - Default Home Page

B&B ELECTRONICS *Make The Right Connections*

[Status](#)
[Configuration](#)
[Certificates](#)
[Network](#)
[Maintenance](#)
Device Type: Industrial Ethernet

Module Status

Module Firmware Version:	3.15
Radio Firmware Version:	3.1.63.21
Link Status:	Connected
SSID:	AP-D23
MAC Address:	000B28FE0109
BSSID:	000B28FE0112
Transmit Rate (Mb/s):	26
Signal Level (dBm):	-27
Noise Level (dBm):	-96
IP Address:	192.168.10.100
Subnet Mask:	255.255.255.0
Default Gateway:	192.168.10.1
Primary DNS:	10.1.0.5
Secondary DNS:	10.1.0.39
Up Time (Sec):	353

[B&B Electronics](#)
 1.815.433.5100 : phone
 1.800.346.3119 : toll free
 1.815.433.5109 : sales fax

[B&B Electronics](#) | [Contact Us](#) | [Technical Support](#)
 © 2009-2013 B&B Electronics

15.1 Navigation Bar

Figure 10 - Website Navigation Bar



Table 19 - Navigation Bar Items

Title	Description
Status	Provides status and performance characteristics for the network interfaces available. Includes connection status, radio and Ethernet statistics.
Configuration	<p>Allows viewing and configuration of all the interface settings including wireless LAN, network connectivity, security, FTP client, serial port and web server.</p> <p>Includes the interface for delivery of OEM and user configuration files, as well as management and viewing of current configurations.</p>
Certificates	This menu item provides the interface for certificate delivery and management. Included in this section are the abilities to view resident certificates, upload and delete certificates.

Title	Description
Network	With this section it is possible to locate other Airborne Device Server modules on the current network. It is also possible to scan for available Access Points.
Maintenance	This section allows the updating of the modules firmware. You can also revert the device settings to OEM defaults and restart the module remotely. The module locate function is also enabled in this section.

15.2 Feature Links

Each Navigation Bar link has a set of Features/Fields it allows access to. These are different for each Navigation option and change for different device selections. The Feature Links are located in the left hand panel of the web page (See Figure 11).

Figure 11- Feature Links

The screenshot displays the B&B Electronics web interface. At the top, the logo and tagline 'Make The Right Connections' are visible. Below the logo is a navigation bar with tabs for Status, Configuration, Certificates, Network, and Maintenance. The 'Network' tab is selected, and the page title is 'Module Status'. The left-hand navigation pane is circled in red and contains the following links: Module Status, Ethernet Status, Ethernet DHCP Clients, Radio Statistics, Ethernet Statistics, and Currently Logged In Users. The main content area displays the following network parameters:

Module Firmware Version:	3.15
Radio Firmware Version:	3.1.63.21
Link Status:	Connected
SSID:	AP-D23
MAC Address:	000B28FE0109
BSSID:	000B28FE0112
Transmit Rate (Mb/s):	26
Signal Level (dBm):	-27
Noise Level (dBm):	-96
IP Address:	192.168.10.100
Subnet Mask:	255.255.255.0
Default Gateway:	192.168.10.1
Primary DNS:	10.1.0.5
Secondary DNS:	10.1.0.39
Up Time (Sec):	353

At the bottom of the page, there is a footer with the B&B Electronics logo, contact information (1.815.433.5100 phone, 1.800.348.3119 toll free, 1.815.433.5109 sales fax), and links for Contact Us and Technical Support. The copyright notice is © 2009-2013 B&B Electronics.

15.3 Navigating the Website

A standard web page looks like Figure 12. The navigation bar runs along the top of the page, page specific feature links are list in the left hand pane of the page and the specific parameters are shown in the main display panel.

Figure 12 - Airborne Web Page

The screenshot shows the B&B Electronics web interface for configuring WLAN parameters. The page title is "WLAN Parameters" and it displays "Current Values" for various settings. The navigation menu on the left includes options like Express Setup, WLAN Settings, Network Settings, and Advanced Settings. The main configuration area includes fields for Radio Startup Mode (On), WLAN Connection Type (Infrastructure), SSID (AP-D23), WLAN TX Power (15 dBm), Maximum Wireless Data Rate (Auto), Use Fixed Data Rate (Disabled), WLAN Region (United States (US)), Preferred Radio Band (Auto), WLAN Maximum Retries (13), and WLAN RTS Threshold (0). Buttons for Commit, Cancel, and Defaults are visible at the bottom of the configuration area.

To select any of the items, move your cursor over the item and press the Left Hand mouse button. The items in the Navigation bar and the Feature Links are hyperlinks and will cause the mouse cursor to change from an arrow pointer to a finger pointer when placed over them.

To find out what a specific field does move the cursor over the field and hover for approximately a second. A help balloon will appear and will provide details on the function of the field and its valid range of values.

15.4 Updating a Field

To update a field, select the field by pressing the Left Hand mouse button. Then either type in the appropriate content or select from the pull down menu.

Once you have finished modifying parameters, scroll to the bottom of the page and press the **Commit** button. The page will then indicate the changes have been completed successfully, you can then return to the configuration page by pressing the **Reload** button or restart the module by pressing the **Reboot** button.



Note that the changes to the parameters will not be applied until a module restart (reboot) has been completed.

Before the **Commit** button has been pressed, all modified fields can be returned to their original state by pressing the **Cancel** button.

15.5 Uploading Certificates

Adding certificates to the Airborne Device Server module is very easy when using the web interface.

Figure 13 - Upload Certificate Web page

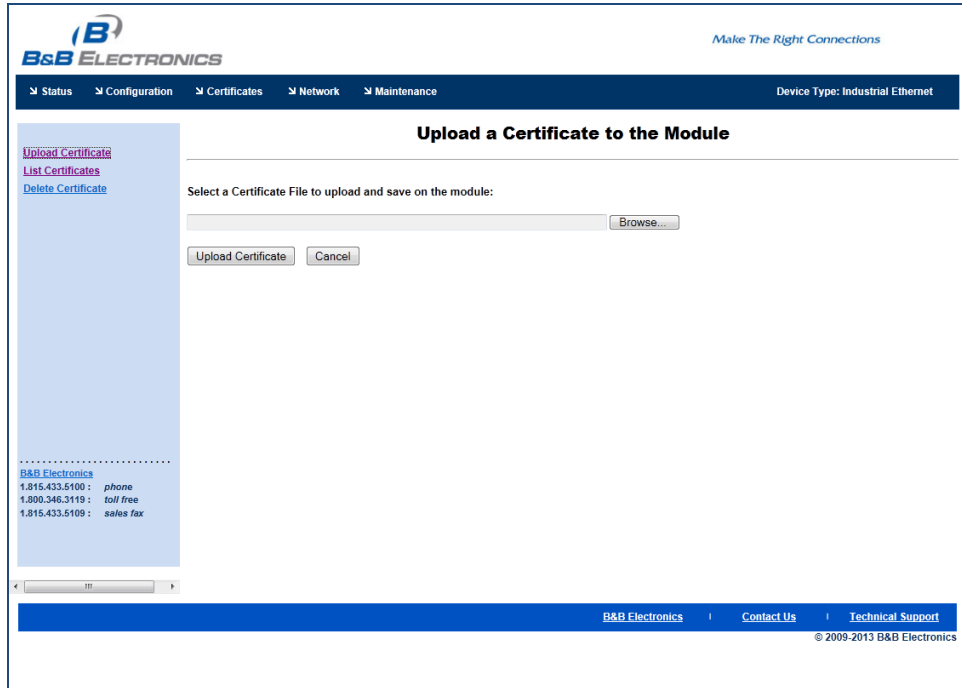

Table 20 - Uploading Certificates

Step	Description
<p><i>Navigation Bar</i> Select Certificates</p>	You will see a list of certificates currently resident on the module when you enter the Certificate File List window.
<p><i>Feature Link</i> Select Upload Certificates</p>	You will see a window open with field to enter the location of the certificate you want to upload.
<p>Press Browse... Button</p>	<p>This will open a dialog box in which you can locate the certificate you wish to upload to the module. Select the Certificate file and press Open.</p> <p>This will return you to the Certificate Upload window and will have entered the location and file name of the certificate you wish to upload in the field next to the Browse... button.</p>
<p>Press Upload Certificate</p>	You will then see a notice that the certificate has been successfully uploaded to the module.
<p>Press List certificates Files</p>	This will show the current certificates resident on the module and will include the file just uploaded.

15.6 Upload Configuration Files

The Airborne Device Server module supports User, Encrypted and OEM configuration files for provisioning the module. Delivery of these configuration files can be performed through the web interface. A full description of these files can be found in the Airborne CLI manual.

To upload configuration files follow the steps in Table 21.

Figure 14 - Upload Configuration Web Page

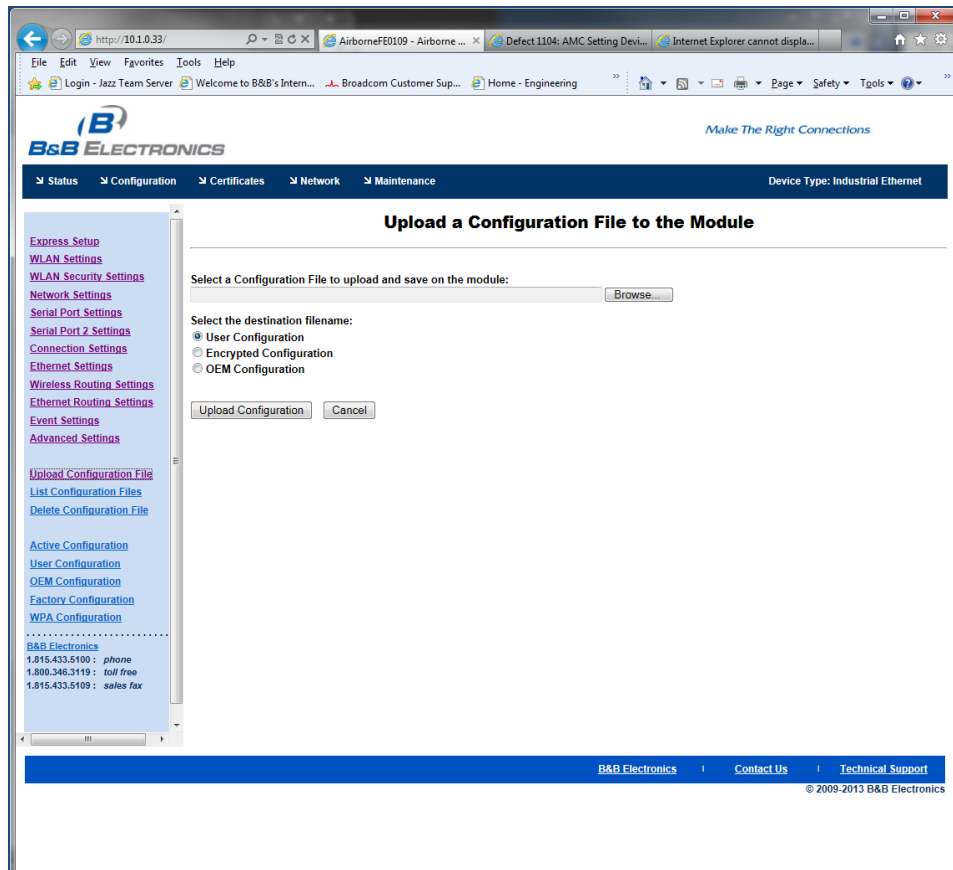



Table 21 - Uploading Configurations

Step	Description
<i>Navigation Bar</i> Select Configuration	You will see major WLAN parameters displayed.
<i>Feature Link</i> Select Upload Configuration File	You will see a window open with field to enter the location of the configuration you want to upload, along with a choice of User, Encrypted or OEM Configuration.

Step	Description
Press Browse... Button	This will open a dialog box in which you can locate the file you wish to upload to the module. Select the configuration file and press Open . This will return you to the Configuration Upload window and will have entered the location and name of the file you wish to upload in the field next to the Browse... button.
Select User, Encrypted or OEM Configuration	This defines the configuration you are installing. Only the OEM Configurations will survive a factory reset.
Press Upload Configuration	You will then see a notice that the configuration has been successfully uploaded to the module.
Press List Configuration Files	This will show the current configuration files resident on the module and will include the file just uploaded.



Uploading a configuration file will overwrite any configuration file already stored on the module. This will cause a change in configuration when a module restart is performed.

IMPORTANT: Confirm that the OEM or USER settings in the configuration files will allow the user to communicate with the module after the upload and a restart has been completed.

15.7 Updating Firmware

The module's firmware may be updated using the web interface. Please refer to Table 22 for the procedure to do this.

Updating the firmware will not alter any existing configuration files or certificates loaded on the module.

You will first need to obtain the version of firmware you wish to install from the B&B Electronics website or B&B Electronics technical support. The firmware will be a binary image file (.img) and indicate the version of the firmware in the file name.

Once you have obtained the firmware, save the firmware image to a location on the system you are browsing the module from, or a location accessible to the system you are browsing the module from.

Figure 15 - Firmware Update Page

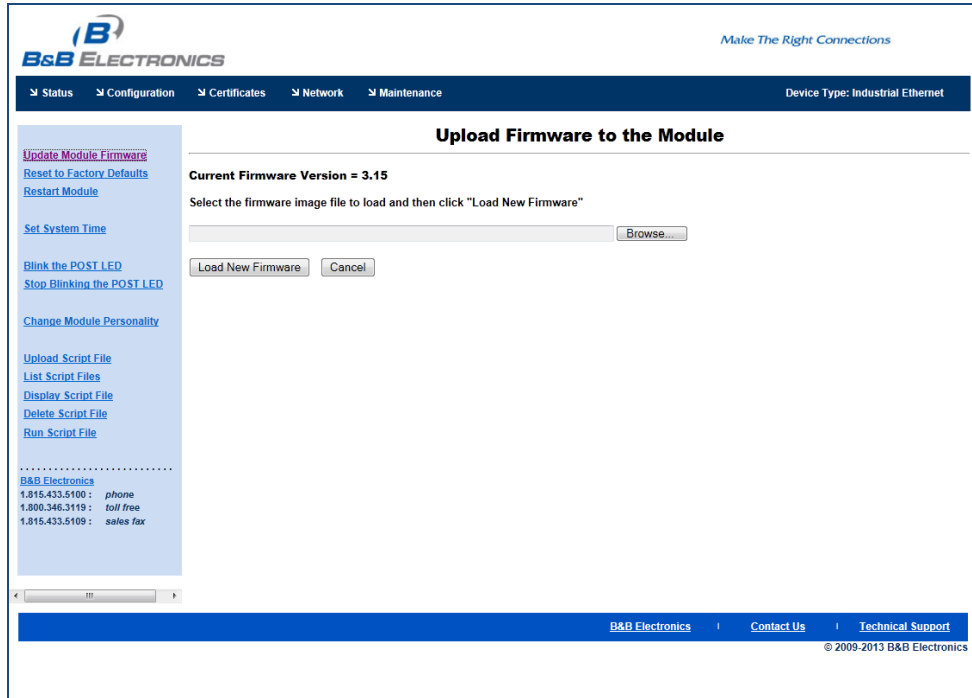

Figure 16 - Firmware Update in Progress

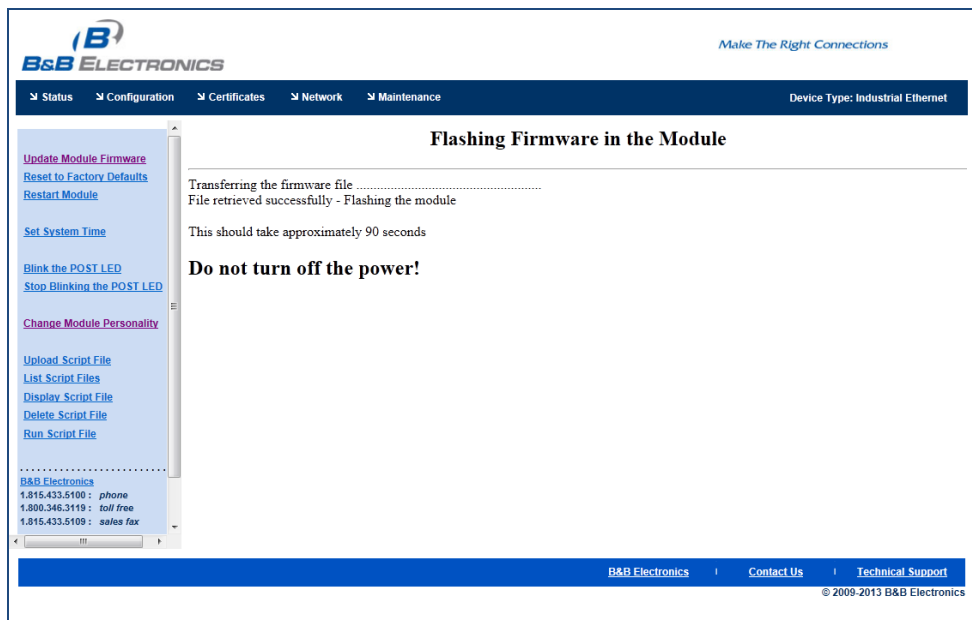

Figure 17 - Firmware Update Complete

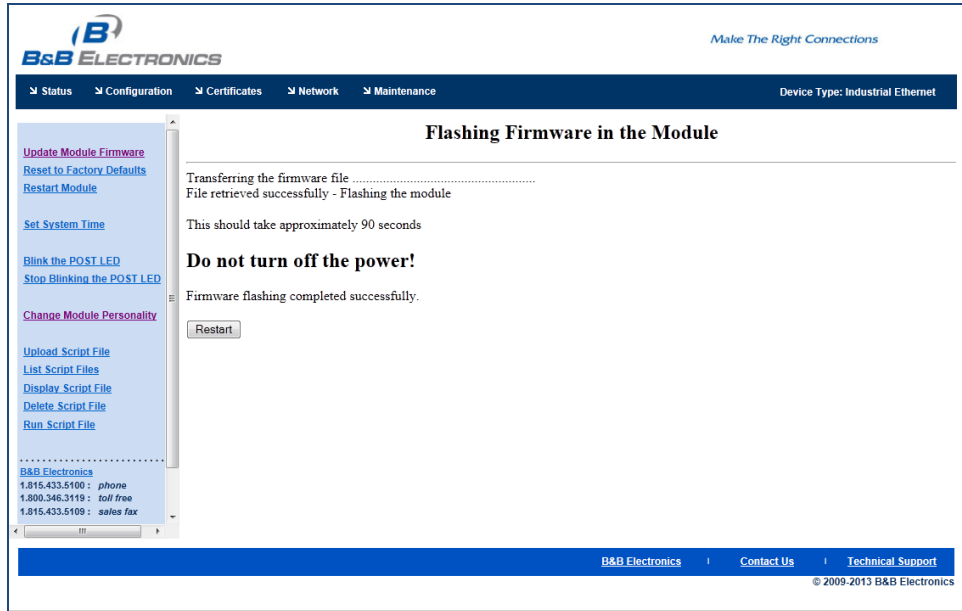



Table 22 - Updating Firmware

Step	Description
Navigation Bar Select Maintenance	This will open a window showing the current module status.
Feature Link Select Update Module Firmware	You will see a window open with field to enter the location of the module firmware you want to upload. The current firmware version number is displayed at the top of the page.
Press Browse... Button	This will open a dialog box in which you can locate the firmware image you wish to upload to the module. Select the firmware image file and press Open . This will return you to the Upload Firmware window and will have entered the location and file name of the firmware image you wish to upload in the field next to the Browse... button.
Press Load New Firmware	You will then see a notice that the firmware upload has begun (Error! Reference source not found.). When the upload has been completed successfully and the firmware updated w window indicating this will be shown (Figure 17).
Press Reboot	This will restart the module and the new firmware will be loaded.



DO NOT REMOVE POWER FROM THE MODULE DURING THE FIRMWARE UPDATE.

This may cause the device to become non-operational. If this happens please contact B&B Electronics Technical Support.

16.0 Express Setup Configuration Page

When the device's web interface is accessed for the first time an Express Setup page will be shown. This page is designed to allow a quick device set-up by presenting the most popular device configuration options in a single location. For more advanced configurations the full set of options are available in the feature links (left-hand column).

The Express Setup web page will display the necessary fields based upon the selections made during configuration. The Express Setup page looks like (Figure 18):

Figure 18 - Express Setup Page

The screenshot shows the B&B Electronics web interface for the Express Setup page. The top navigation bar includes Status, Configuration, Certificates, Network, and Maintenance. The left sidebar lists various configuration options, with 'Express Setup' selected. The main configuration area is divided into sections: Express Setup (Discovery OEM Device Name: OEM-Cfg1, Radio Startup Mode: On), WLAN Parameters (WLAN Connection Type: Infrastructure, SSID: AP-D23, WLAN Security Type: WPA2-PSK), Ethernet Parameters (Ethernet Role: Router, Ethernet DHCP Server Enabled: Enable), and IP Address Parameters (WLAN DHCP: Enabled, Ethernet DHCP: Disabled, Ethernet Static IP Address: 10.1.3.190, Ethernet Subnet Mask: 255.255.0.0, Ethernet Gateway Address: 10.1.0.33). At the bottom, there are buttons for Commit, Cancel, and Defaults.

To configure the device for operation each field must be configured correctly. The following steps should be taken to configure the device (Note: not all fields will be visible):

Table 23 - Express Page Setup

Step	Description
Navigation Bar Select Configuration	You will see a group of fields under the banner of WLAN Parameters.
Feature Link Select Express Setup	This step is optional. If this is the first time the device has been configured this page will automatically be displayed.

Step	Description
Select Discovery OEM Device Name	<p>This parameter allows you to name the device uniquely or group into a functional set. When device discovery is used this name identifies the found device.</p> <p>If you wanted to uniquely identify the device you could mark it with a label e.g. Dev1, and then enter Dev1 in this field. When the device is found it will identify itself as Dev1.</p> <p>Alternately you could indicate the type of equipment the device is attached to e.g. Haas TL-2 (CNC Turning Center), by giving the unit a name like Haas_TL_2. When discovered you can then identify the device you are accessing.</p> <p>Enter the text string is you wish to change the default value. This field is optional.</p>
Select Radio Startup Mode	Select On from the drop down menu for the radio to operate.
Select Wireless LAN Connection Type	<p>If you are using Access Points make sure this is set to Infrastructure from the drop down menu.</p> <p>If you want to use AdHoc set this accordingly. Additional settings may be required to fully configure for AdHoc mode, these are covered if section 17.2.</p>
Select SSID	Enter the name of the wireless network you wish to access. This field is case sensitive.
Select Wireless LAN Security Type	<p>Select the security type the wireless network you wish to access is using.</p> <p>Depending upon the option you choose you may have to enter additional information. Once you have selected the security type the required inputs will be displayed. All displayed fields must be completed.</p> <p>If the security type is not in the available selections more are available in the <i>WLAN Security Settings</i> page. If you choose to use this page make sure you commit the change before selecting the <i>WLAN Security Settings</i> page.</p>
Select WLAN DHCP	<p>If your WLAN network uses DHCP to assign IP addresses to the wireless clients, select Enabled from the drop down menu.</p> <p>If you are using static IP addresses select disabled from the drop down menu. WLAN Static IP and WLAN Subnet Mask will need to be entered.</p>
Select Ethernet DHCP	<p>If the Ethernet network connected to the Ethernet port uses DHCP to assign IP addresses to the wired clients, you should select Enabled from the drop down menu.</p> <p>If you are using static IP addresses you should select Disabled from the drop down menu. Ethernet Static IP and Ethernet Subnet Mask will need to be entered.</p> <p>Important: This field is only used if the Ethernet interface is set as a client (default for Serial devices). If set as a router the field is ignored. See section 21.0 for a full description of configuring the unit as an Ethernet router.</p>
Select WLAN Static IP	<p>This field defines the static IP address for the wireless interface.</p> <p>This address is only used if the WLAN DHCP is disabled or DHCP failed.</p> <p>Default: 192.168.10.1</p>
Select WLAN Subnet Mask	<p>This field defines the subnet mask used by the wireless interface.</p> <p>This mask is only used if the WLAN DHCP is disabled or DHCP failed.</p> <p>Default: 255.255.255.0</p>

Step	Description
Select Ethernet Static IP	This field defines the static IP address for the Ethernet interface. When configured as a serial device server (Ethernet interface is in client mode) this address is only used if the Ethernet DHCP is disabled or DHCP failed. Default: 192.168.2.100
Select Ethernet Subnet Mask	This field defines the subnet mask used by the Ethernet interface. When configured as a serial device server (Ethernet interface is in client mode) this mask is only used if the Ethernet DHCP is disabled or DHCP failed. Default: 255.255.255.0
Select Ethernet Gateway Address	This field defines the gateway IP address used by the Ethernet interface. When configured as a serial device server (Ethernet interface is in client mode) this mask is only used if the Ethernet DHCP is disabled or DHCP failed. Default: 192.168.2.1
Press Commit [Button]	Saves changes to the device.
<i>Optional</i> Press Reload [Button]	Reloads the Express Settings page. Select this is you have further configuration options to change.
<i>Optional</i> Press Restart [Button]	Restarts the device. After the device as rebooted it will attempt to authenticate to the configured network. As long as the network is in range the wireless interface will connect. If the network is using DHCP then an IP address will be assigned to the WLAN interface and IP connectivity is possible over the WLAN network. If the network is using static IP addresses it will be necessary to configure the network interface, see the next step.

The web interface supports advanced configuration of the device through the additional pages available. The following sections provide guidance on how to use these pages for specific configurations.

17.0 Configuring the Wireless Interface

The following section will outline how to configure the wireless interface for both infrastructure and AdHoc networks.

17.1 Configuring for Infrastructure Networks

Infrastructure networks use Access Point and/or Wireless Routers to provide wireless access to a network. Each wireless network is identified by a name referred to as the SSID (**S**ervice **S**et **I**Dentifier). To configure the device with the necessary parameters to operate with an Infrastructure network use the following steps.

Table 24 - Configuring Wireless Interface - Infrastructure

Step	Description
<i>Navigation Bar</i> Select Configuration	You will see a group of fields under the banner of WLAN Parameters.
<i>Feature Link</i> Select WLAN Settings	This step is optional. The default home page for the Configuration link in the Navigation Bar is WLAN Settings .
Select Radio Startup Mode	Select On from the drop down list.
Select Wireless LAN Connection Type	Select the Infrastructure form the drop down list.
Select SSID	Enter the name of the wireless network you want the device to use. This cannot include spaces.
Select Wireless LAN Region	Select the most appropriate region for the deployment location of the device.
Press Commit [Button]	Saves changes to the device.
Press Reload [Button]	Reloads the WLAN Settings page.
<i>Feature Link</i> Select WLAN Security Settings	The wireless interface is now configured however most wireless networks use security to protect the network and users from unauthorized use. Selecting WLAN Security Settings will allow us to configure the devices security settings for the network. This is covered in section 18.0.

17.2 Configuring for AdHoc Networks

AdHoc networks use peer-to-peer connection to create a local wireless network. These can be useful when no infrastructure (AP) is available. Each wireless network is identified by a name referred to as the ESSID (Extended Service Set Identifier). To configure the device with the necessary parameters to operate with an AdHoc use the following steps.

Table 25 - Configuring Wireless Interface - AdHoc

Step	Description
<i>Navigation Bar</i> Select Configuration	You will see a group of fields under the banner of WLAN Parameters.
<i>Feature Link</i> Select WLAN Settings	This step is optional. The default home page for the Configuration link in the Navigation Bar is WLAN Settings .
Select Radio Startup Mode	Select On from the drop down list.
Select Wireless LAN Connection Type	Select the AdHoc form the drop down list.
Select Wireless LAN Channel	This determines the 802.11 channel that the device will use when it establishes a connection with another device in the AdHoc network. Select a channel that is clear, i.e. one which has no other 802.11 network using it. It is not necessary for all devices in a single AdHoc network to have the same channel number selected.
Select SSID	Enter the name of the wireless network you want the device to use. This cannot include spaces.
Select Wireless LAN Region	Select the most appropriate region for the deployment location of the device.
Press Commit [Button]	Saves changes to the device.
Press Reload [Button]	Reloads the WLAN Settings page.
<i>Feature Link</i> Select WLAN Security Settings	The wireless interface is now configured however most wireless networks use security to protect the network and users from unauthorized use. Selecting WLAN Security Settings will allow us to configure the devices security settings for the network. This is covered in section 18.
<i>Feature Link</i> Select Network Settings	The wireless interface is now configured however most AdHoc networks do not have a DHCP server available to provide IP address to the devices in the network. It therefore necessary to assign a static IP address to the wireless interface. Selecting Network Settings will allow us to configure the device with a static IP address. This is covered in section 19.0. A bridge unit will require static IP addresses.

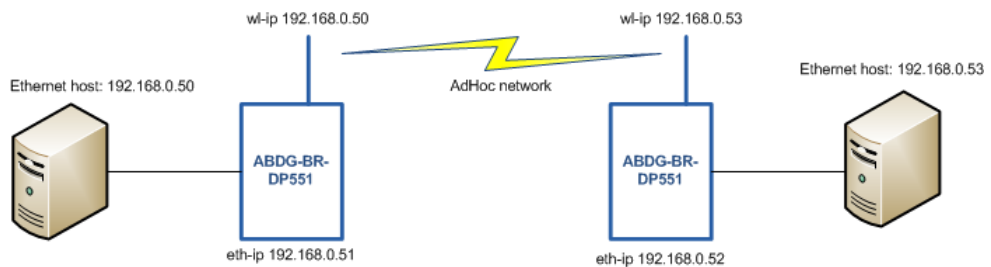

18.0 Configuring the Security Settings

Almost all 802.11 networks will use some sort of security to protect the network from unauthorized use. There are many types of security options available. The following section will cover how to configure the device for the most popular options. If your security configuration is not covered, further details can be found in the Airborne Enterprise CLI Reference Manual.

18.1 Configuring for WEP Security

Although an old protocol WEP is still used by many networks. The Airborne device supports many variations of WEP however we will only cover the most popular in the following table. If the basic 64 or 128 bit WEP configuration does not work please refer to the Airborne Enterprise CLI Reference Manual for the other options available.

Table 26 - Configuring for WEP Security

Step	Description
<i>Navigation Bar</i> Select Configuration	You will see a group of fields under the banner of WLAN Parameters.
<i>Feature Link</i> Select WLAN Security Settings	The wireless interface must be configured before configuring the security for the network. A page showing the range of security options and fields is displayed.
Select Wireless LAN Security	Select WEP64 or WEP128 from the drop down list. The options identify the length of the key that will be used with the security protocol.
Select Authentication Type	Select Auto from the drop down list. This field should not need to be changed. Only modify if you have been specifically told to by the network administrator.
Select Default WEP Key	Select the key number that matches the selection used by the AP's in the wireless network. This must match for authentication to be successful. There must be a valid key in the selected key number field.
Select WEP Key 1 - 4	Select the key field that matches the one selected in Default WEP Key field. Enter the key exactly as it is entered into the AP. If WEP64 is selected the key length is 10 digits. If WEP128 is selected the key length is 26 digits. More than one key field can be completed.
Press Commit [Button]	Saves changes to the device.
<i>Optional</i> Press Reload [Button]	Reloads the WLAN Settings page. Select this if you have further configuration options to change.

Step	Description
<i>Optional</i> Press Restart [Button]	Restarts the device. After the device as rebooted it will attempt to authenticate to the configured network. As long as the network is in range the wireless interface will connect. If the network is using DHCP then an IP address will be assigned to the WLAN interface and IP connectivity is possible over the WLAN network. If the network is using static IP addresses it will be necessary to configure the network interface, see the next step.
<i>Feature Link</i> Select Network Settings	The wireless interface is now configured however if the WLAN network does not have a DHCP server available to provide IP address to the device, it necessary to assign a static IP address to the wireless interface. Selecting Network Settings will allow us to configure the device with a static IP address. This is covered in section 19.0.

18.2 Configuring for WPA-PSK Security

This security type is a very popular type and is easy to configure. Most often used in SOHO and home environments, some enterprise networks do use it.

Table 27 - Configuring for WPA Security

Step	Description
<i>Navigation Bar</i> Select Configuration	You will see a group of fields under the banner of WLAN Parameters.
<i>Feature Link</i> Select WLAN Security Settings	The wireless interface must be configured before configuring the security for the network. A page showing the range of security options and fields is displayed.
Select Wireless LAN Security	Select WPA-PSK from the drop down list.
Select WPA Protocol Version	Select Auto from the drop down list. This field should not need to be changed. Only modify if you have been specifically told to by the network administrator.
Select WPA/WPA2 Pre Shared Key (PSK)	Enter the PreShared Key used by the AP. The PSK is case sensitive and must be entered exactly as it is in the AP. The PSK cannot include spaces.
Press Commit [Button]	Saves changes to the device.
<i>Optional</i> Press Reload [Button]	Reloads the WLAN Settings page. Select this is you have further configuration options to change.

Step	Description
<i>Optional</i> Press Restart [Button]	Restarts the device. After the device is rebooted it will attempt to authenticate to the configured network. As long as the network is in range the wireless interface will connect. If the network is using DHCP then an IP address will be assigned to the WLAN interface and IP connectivity is possible over the WLAN network. If the network is using static IP addresses it will be necessary to configure the network interface, see the next step.
<i>Feature Link</i> Select Network Settings	The wireless interface is now configured however if the WLAN network does not have a DHCP server available to provide IP address to the device, it is necessary to assign a static IP address to the wireless interface. Selecting Network Settings will allow us to configure the device with a static IP address. This is covered in section 19.0.

18.3 Configuring for WPA2-PSK Security

This security type is a very popular type and is easy to configure. Most often used in SOHO and home environments, WPA2-PSK is starting to be widely used by enterprise networks.

Table 28 - Configuring for WPA2 Security

Step	Description
<i>Navigation Bar</i> Select Configuration	You will see a group of fields under the banner of WLAN Parameters.
<i>Feature Link</i> Select WLAN Security Settings	The wireless interface must be configured before configuring the security for the network. A page showing the range of security options and fields is displayed.
Select Wireless LAN Security	Select WPA2-PSK from the drop down list.
Select WPA/WPA2 Pre Shared Key (PSK)	Enter the PreShared Key used by the AP. The PSK is case sensitive and must be entered exactly as it is in the AP. The PSK cannot include spaces.
Press Commit [Button]	Saves changes to the device.
<i>Optional</i> Press Reload [Button]	Reloads the WLAN Settings page. Select this if you have further configuration options to change.

Step	Description
<i>Optional</i> Press Restart [Button]	Restarts the device. After the device as rebooted it will attempt to authenticate to the configured network. As long as the network is in range the wireless interface will connect. If the network is using DHCP then an IP address will be assigned to the WLAN interface and IP connectivity is possible over the WLAN network. If the network is using static IP addresses it will be necessary to configure the network interface, see the next step.
<i>Feature Link</i> Select Network Settings	The wireless interface is now configured however if the WLAN network does not have a DHCP server available to provide IP address to the device, it necessary to assign a static IP address to the wireless interface. Selecting Network Settings will allow us to configure the device with a static IP address. This is covered in section 19.0.

18.4 Configuring for PEAP Security

This security type is a very popular type for enterprise networks. Actual use of the security protocol requires the network is using a RADIUS server for device authentication, depending upon the security policies of the network this protocol supports authentication with and without a CA certificate.

The Airborne device supports PEAPv0 using both WPA (TKIP) and WPA2 (AES-CCMP) encryption. The device will automatically use the most appropriate encryption type to obtain authentication to the WLAN.

Table 29 - Configuring for PEAP Security

Step	Description
<i>Navigation Bar</i> Select Configuration	You will see a group of fields under the banner of WLAN Parameters.
<i>Feature Link</i> Select WLAN Security Settings	The wireless interface must be configured before configuring the security for the network. A page showing the range of security options and fields is displayed.
Select Wireless LAN Security	Select PEAP from the drop down list.
Select EAP Identity	Enter the RADIUS server account name provided by the network administrator. If a Windows domain server is being used for authentication the server domain must be included in the EAP Ident field
Select EAP Password	Enter the RADIUS server account password for the EAP Ident .
Select EAP Phase 1 String	Enter <code>peaplabel=0</code>
Select EAP Phase 1 String	Enter <code>auth=MSCHAPV2</code>

Step	Description
Select CA Certificate Filename	<p>Enter the name of the Certificate Authority (CA) certificate stored on the device.</p> <p>Storing Certificates on the device is cover in section 15.5.</p> <p>If the network security does not require the use of a CA certificate this field should be left blank.</p>
Press Commit [Button]	Saves changes to the device.
<i>Optional</i> Press Reload [Button]	Reloads the WLAN Settings page. Select this is you have further configuration options to change.
<i>Optional</i> Press Restart [Button]	<p>Restarts the device. After the device as rebooted it will attempt to authenticate to the configured network. As long as the network is in range the wireless interface will connect.</p> <p>If the network is using DHCP then an IP address will be assigned to the WLAN interface and IP connectivity is possible over the WLAN network.</p> <p>If the network is using static IP addresses it will be necessary to configure the network interface, see the next step.</p>
<i>Feature Link</i> Select Network Settings	<p>The wireless interface is now configured however if the WLAN network does not have a DHCP server available to provide IP address to the device, it necessary to assign a static IP address to the wireless interface.</p> <p>Selecting Network Settings will allow us to configure the device with a static IP address. This is covered in section 19.0.</p>

19.0 Configuring Network Settings

Once the device is authenticated to a wireless network communication is possible, however before TCP/IP connectivity can be achieved the device must obtain a valid IP address on the WLAN and/or Ethernet interface.

The Airborne device supports both DHCP and Static IP addressing for both the WLAN and Ethernet interfaces. The following sections cover the correct configuration for both DHCP and Static IP addressing on the interfaces.

When the Ethernet interface is in client mode DHCP can be used on either the WLAN or Ethernet interface but not on both interfaces at the same time.

The Ethernet interface configuration only applies when the interface is in client mode and is being used by a serial device server. The configuration of the Ethernet interface when being used with the Ethernet adapter (ABDx-ER) products is covered in section 21.0.



The Ethernet configuration sections do not apply to devices that do not have an available Ethernet port; these include but are not limited to the ABDx-SE-DP5xx product families.

19.1 Configuring DHCP on WLAN Interface

DHCP enabled on the WLAN interface is the default configuration for the Ethernet devices. For serial devices the default is DHCP disabled on the WLAN interface. It requires that there is a DHCP server on the WLAN network the device has authenticated to and that the necessary network policies will allow the server to lease an address to the Airborne™ device.

Table 30 - Configuring DHCP - WLAN

Step	Description
<i>Navigation Bar</i> Select Configuration	You will see a group of fields under the banner of WLAN Parameters.
<i>Feature Link</i> Select Network Settings	The wireless interface and security must be configured before configuring the network settings. A page showing the range of network options and fields, for both the WLAN and Ethernet interfaces, is displayed.
Select WLAN DHCP	Select Enabled from the dropdown menu.
<i>Optional</i> Select WLAN DHCP Name	Provides a method of uniquely identifying the device in the DHCP lease table on the DHCP server. The default name is AirborneXXXXXX , where XXXXXX matches the last 6 octets of the WLAN interface MAC address.
Press Commit [Button]	Saves changes to the device.

Step	Description
<i>Optional</i> Press Reload [Button]	Reloads the Network Settings page. Select this if you have further configuration options to change.
<i>Optional</i> Press Restart [Button]	Restarts the device. After the device as rebooted it will attempt to authenticate to the configured network. As long as the network is in range the wireless interface will connect. Once authenticated the network should lease an IP address to the WLAN interface and IP connectivity is possible over the WLAN network.

19.2 Configuring DHCP on Ethernet Interface

DHCP enabled on the Ethernet interface is the default configuration for the serial devices. The Ethernet interface must be in client mode for this setting to be used.

The Airborne Device does not support the ability to enable DHCP on the WLAN and Ethernet interfaces simultaneously (when in client mode). Only one may have DHCP enabled at a time. The other interface must be configured to use a static IP address.

Table 31 - Configuring DHCP - Ethernet

Step	Description
<i>Navigation Bar</i> Select Configuration	You will see a group of fields under the banner of WLAN Parameters.
<i>Feature Link</i> Select Ethernet Settings	The wireless interface and security must be configured before configuring the Ethernet settings. A page showing the range of Ethernet options and fields, setting the mode of operation for the Ethernet interface is done in this page.
Select Ethernet Role	Select Client from the drop down menu.
Press Commit [Button]	Saves changes to the device.
Press Reload [Button]	Reloads the Ethernet Settings page.
<i>Feature Link</i> Select Network Settings	The wireless interface and security must be configured before configuring the network settings. A page showing the range of network options and fields, for both the WLAN and Ethernet interfaces, is displayed.
Select Ethernet DHCP	Select Enabled from the drop down menu.
<i>Optional</i> Select WLAN DHCP Name	Provides a method of uniquely identifying the device in the DHCP lease table on the DHCP server. The default name is AirborneXXXXXX , where XXXXXX matches the last 6 hexadecimal digits of the Ethernet interface MAC address.

Step	Description
Press Commit [Button]	Saves changes to the device.
<i>Optional</i> Press Reload [Button]	Reloads the Network Settings page. Select this is you have further configuration options to change.
<i>Optional</i> Press Restart [Button]	Restarts the device. After the device as rebooted it will attempt to authenticate to the configured network. As long as the network is in range the wireless interface will connect. Once authenticated the network should lease an IP address to the WLAN interface and IP connectivity is possible over the WLAN network.

19.3 Configuring a Static IP Address on WLAN Interface

Static IP addresses on the WLAN interface is the default configuration for serial devices. It is important to verify the address being entered is unique to the device when on the network.

Table 32 - Configuring Static IP - WLAN

Step	Description
<i>Navigation Bar</i> Select Configuration	You will see a group of fields under the banner of WLAN Parameters.
<i>Feature Link</i> Select Network Settings	The wireless interface and security must be configured before configuring the network settings. A page showing the range of network options and fields, for both the WLAN and Ethernet interfaces, is displayed.
Select WLAN DHCP	Select Disable from the drop down menu.
Select WLAN Static IP Address	Enter the assigned static IP address. The address must be in the format: XXX.XXX.XXX.XXX
Select Subnet Mask	Enter the subnet mask for the network. The mask must be in the format: XXX.XXX.XXX.XXX
Select Gateway IP Address	Enter the assigned Gateway IP address. The address must be in the format: XXX.XXX.XXX.XXX
Press Commit [Button]	Saves changes to the device.
<i>Optional</i> Press Reload [Button]	Reloads the Network Settings page. Select this is you have further configuration options to change.

Step	Description
<i>Optional</i> Press Restart [Button]	Restarts the device. After the device as rebooted it will attempt to authenticate to the configured network. As long as the network is in range the wireless interface will connect. Once authenticated the network will use the assigned static IP address on the WLAN interface making IP connectivity possible over the WLAN network.

19.4 Configuring a Static IP Address on Ethernet Interface

This is not the default configuration for the Ethernet interface. It is important to verify the address being entered is unique to the device when on the network.

The Airborne Device does not support the ability to enable DHCP on the WLAN and Ethernet interfaces simultaneously (when in client mode). Only one may have DHCP enabled at a time, the other interface must be configured to use a static IP address.

Table 33 - Configuring Static IP - Ethernet

Step	Description
<i>Navigation Bar</i> Select Configuration	You will see a group of fields under the banner of WLAN Parameters.
<i>Feature Link</i> Select Ethernet Settings	The wireless interface and security must be configured before configuring the Ethernet settings. A page showing the range of Ethernet options and fields, setting the mode of operation for the Ethernet interface is done in this page.
Select Ethernet Role	Select Client from the drop down menu.
Press Commit [Button]	Saves changes to the device.
Press Reload [Button]	Reloads the Ethernet Settings page.
<i>Feature Link</i> Select Network Settings	The wireless interface and security must be configured before configuring the network settings. A page showing the range of network options and fields, for both the WLAN and Ethernet interfaces, is displayed.
Select Ethernet DHCP	Select Disable from the drop down menu.
Select Ethernet Static IP Address	Enter the assigned static IP address. The address must be in the format: XXX.XXX.XXX.XXX
Select Ethernet Subnet Mask	Enter the subnet mask for the network. The mask must be in the format: XXX.XXX.XXX.XXX

Step	Description
Select Ethernet Gateway IP Address	Enter the assigned Gateway IP address. The address must be in the format: XXX.XXX.XXX.XXX
Press Commit [Button]	Saves changes to the device.
<i>Optional</i> Press Reload [Button]	Reloads the Network Settings page. Select this if you have further configuration options to change.
<i>Optional</i> Press Restart [Button]	Restarts the device. After the device as rebooted it will attempt to authenticate to the configured network. As long as the network is in range the wireless interface will connect. Once authenticated the network will use the assigned static IP address on the Ethernet interface making IP connectivity possible over the Ethernet network.

20.0 Configuring Serial Device Server

The ABDx-SE-DP5xx/IN5xxx devices are shipped preconfigured for use as Serial Device Servers. All that is required is configuration of the WLAN parameters and security protocols; however the following section will cover the full configuration of a Serial Device Server to aid in the installation and deployment of the units.

If the Windows Virtual COM port driver is being used with the device, configure only the WLAN network parameters and security protocols through the web interface. All other parameters will be controlled by the VCOM driver. Installation and configuration of the VCOM driver is covered in section 21.0.

The following section shows how to manually configure the unit to accept TCP/IP connections and automatically set-up a data tunnel with one of the serial ports. The configuration is independent of the source of the request, as the tunnel ports are available to both the WLAN and Ethernet interfaces.

The Airborne devices support conditional tunnel binding based upon rules included in the configuration. The major options will be included.

20.1 Configuring Serial Port for Access on Telnet Port

A data tunnel can be made using the device's telnet port as the network connection port. This does require authenticating with the device and manually initiating the tunnel connection. Configuring the device to support this approach to establishing a data tunnel is covered in the following table.

Table 34 – Configure Data Tunnel on Telnet Port

Step	Description
<i>Navigation Bar</i> Select Configuration	You will see a group of fields under the banner of WLAN Parameters.
<i>Feature Link</i> Select Connection Settings	The wireless interface and security must be configured before configuring the Ethernet settings. A page showing the configuration options for TCP/IP and UDP connections to the device. Configuration of Telnet, HTTP and SSH ports is possible through this page.
Select Telnet Port	Enter the port number you wish to use for a telnet (TCP/IP) connection to the device. The default 23 should only be changed if your application requires access to port 23 for another purpose.
Press Commit [Button]	Saves changes to the device.
Press Reload [Button]	Reloads the Connection Settings page.

Step	Description
<i>Feature Link</i> Select Serial Port 1 Settings/Serial Port 2 Settings	The wireless interface and security must be configured before configuring the Ethernet settings. Displays a page showing the serial port configuration, setting the default mode of operation for the serial interface is done in this page.
Select Serial CLI Default Mode	Select Listen from the drop down menu.
Press Commit [Button]	Saves changes to the device.
<i>Optional</i> Press Reload [Button]	Reloads the Serial Port X Settings page. Select this is you have further configuration options to change.
<i>Optional</i> Press Restart [Button]	Restarts the device. After the device as rebooted it will attempt to authenticate to the configured network. As long as the network is in range the wireless interface will connect. Once authenticated the network it is possible for a TCP/IP connection to be made on the Telnet port.

To establish a data tunnel and gain access to the serial data from the WLAN or Ethernet interface follow the steps in Table 35.

Table 35 - Data Tunnel using Telnet Port

Step	Description
Open TCP socket to device	Using the WLAN IP Address and configured telnet port number.
Authenticate with device	<code>auth dpac dpac</code> Any user level above L5 can authenticate with the unit. Device responds <code>OK</code>
Open data tunnel to serial port	<code>pass-x</code> Where <code>x</code> can be <code>p1</code> , <code>p2</code> or <code>any</code> . <code>p1</code> or <code>p2</code> binds to the indicated serial port, as long as the serial port is in listen mode and does not already have a data tunnel open. <code>any</code> binds to the first serial port which is in listen mode and does not already have a data tunnel open.

20.2 Configuring Serial Port 1 for Access on Tunnel Port

A data tunnel can be made using the devices tunnel port as the network connection port. This does not require authenticating with the device and automatically initiates the tunnel connection. Configuring the device to support this approach to establishing a data tunnel is covered in the following table.

Table 36 – Configure Data Tunnel on Serial Port 1 Tunnel Port (TCP)

Step	Description
<i>Navigation Bar</i> Select Configuration	You will see a group of fields under the banner of WLAN Parameters.
<i>Feature Link</i> Select Connection Settings	The wireless interface and security must be configured before configuring the Ethernet settings. A page showing the configuration options for TCP/IP and UDP connections to the device. Configuration of Telnet, HTTP and SSH ports is possible through this page.
Select Tunnel Enabled	Select Enabled .
Select Tunnel Port	Enter the port to be used for the tunnel. Default is 8023 , this should only be changed if a port is already defined for the application server or it is already being used by another service.
Select Tunnel Mode	Select TCP from drop down menu.
Press Commit [Button]	Saves changes to the device.
Press Reload [Button]	Reloads the Connection Settings page.
<i>Feature Link</i> Select Serial Port Settings	The wireless interface and security must be configured before configuring the Ethernet settings. Displays a page showing the serial port configuration, setting the default mode of operation for the serial interface is done in this page.
Select Serial CLI Default Mode	Select Listen from the drop down menu.
Press Commit [Button]	Saves changes to the device.
<i>Optional</i> Press Reload [Button]	Reloads the Serial Port Settings page. Select this is you have further configuration options to change.
<i>Optional</i> Press Restart [Button]	Restarts the device. After the device as rebooted it will attempt to authenticate to the configured network. As long as the network is in range the wireless interface will connect. Once authenticated the network it is possible for a TCP/IP connection to be made on the Telnet port.

To establish a data tunnel and gain access to the serial data from the WLAN or Ethernet interface follow the steps in Table 37.

Table 37 - Data Tunnel using Tunnel Port on Serial Port 1

Step	Description
Open TCP socket to device	Using the WLAN IP Address and configured tunnel port number for Serial Port 1 (Default 8023).

20.3 Configuring Serial Port 2 for Access on Tunnel Port

A data tunnel can be made using the devices tunnel port as the network connection port. This does not require authenticating with the device and automatically initiates the tunnel connection. Configuring the device to support this approach to establishing a data tunnel is covered in the following table.

Table 38 – Configure Data Tunnel on Serial Port 2 Tunnel Port (TCP)

Step	Description
<i>Navigation Bar</i> Select Configuration	You will see a group of fields under the banner of WLAN Parameters.
<i>Feature Link</i> Select Connection Settings	The wireless interface and security must be configured before configuring the Ethernet settings. A page showing the configuration options for TCP/IP and UDP connections to the device. Configuration of Telnet, HTTP and SSH ports is possible through this page.
Select Tunnel Enabled – Serial Port 2	Select Enabled .
Select Tunnel Port – Serial Port 2	Enter the port to be used for the tunnel. Default is 8024 , this should only be changed if a port is already defined for the application server or it is already being used by another service.
Select Tunnel Mode – Serial Port 2	Select TCP from drop down menu.
Press Commit [Button]	Saves changes to the device.
Press Reload [Button]	Reloads the Connection Settings page.
<i>Feature Link</i> Select Serial Port 2 Settings	The wireless interface and security must be configured before configuring the Ethernet settings. Displays a page showing the serial port configuration, setting the default mode of operation for the serial interface is done in this page.
Select Serial CLI Default Mode	Select Listen from the drop down menu.
Press Commit [Button]	Saves changes to the device.
<i>Optional</i> Press Reload [Button]	Reloads the Serial Port 2 Settings page. Select this is you have further configuration options to change.
<i>Optional</i> Press Restart [Button]	Restarts the device. After the device as rebooted it will attempt to authenticate to the configured network. As long as the network is in range the wireless interface will connect. Once authenticated the network it is possible for a TCP/IP connection to be made on the Telnet port.

To establish a data tunnel and gain access to the serial data from the WLAN or Ethernet interface follow the steps in Table 39.

Table 39 - Data Tunnel using Tunnel Port on Serial Port 2

Step	Description
Open TCP socket to device	Using the WLAN IP Address and configured tunnel port number for Serial Port 2 (Default 8024).

20.4 Configuring Serial Port 1 as TCP Client

In this mode the device will attempt to initiate a TCP connection to a network based server and establish a data tunnel with Serial Port 1 on a successful network connection.

Table 40 - Configure Serial Port 1 as TCP Client

Step	Description
<i>Navigation Bar</i> Select Configuration	You will see a group of fields under the banner of WLAN Parameters.
<i>Feature Link</i> Select Connection Settings	The wireless interface and security must be configured before configuring the Ethernet settings. A page showing the configuration options for TCP/IP and UDP connections to the device. Configuration of Telnet, HTTP and SSH ports is possible through this page.
Select TCP Port	Enter the port on which the target server is listening for TCP connections.
Select TCP Timeout	Enter the inactivity timeout in seconds, after which the device will close the open data tunnel on Serial Port 1. The default 0 disables the timeout.
Select TCP Retry Time	Enter the period (in seconds) the device should use to retry establishing the TCP connection to the target server.
Select Primary TCP Target Server IP Address	Enter the IP address of the primary target server. The address must be in the format: XXX.XXX.XXX.XXX
<i>Optional</i> Select Secondary TCP Target Server IP Address	Enter the IP address of the secondary target server. The address must be in the format: XXX.XXX.XXX.XXX This address will be used if the initial attempts to connect to the primary server fail. This field is optional.
Press Commit [Button]	Saves changes to the device.
Press Reload [Button]	Reloads the Connection Settings page.

Step	Description
<i>Feature Link</i> Select Serial Port 1 Settings	The wireless interface and security must be configured before configuring the Ethernet settings. Displays a page showing the serial port configuration, setting the default mode of operation for the serial interface is done in this page.
Select Serial CLI Default Mode	Select Pass from the drop down menu.
Press Commit [Button]	Saves changes to the device.
<i>Optional</i> Press Reload [Button]	Reloads the Serial Port 1 Settings page. Select this is you have further configuration options to change.
<i>Optional</i> Press Restart [Button]	Restarts the device. After the device as rebooted it will attempt to authenticate to the configured network. As long as the network is in range the wireless interface will connect. Once authenticated to the network it the device will attempt to make a TCP connection with primary target server, using the configured port number.

20.5 Configuring Serial Port 2 as TCP Client

In this mode the device will attempt to initiate a TCP connection to a network based server and establish a data tunnel with Serial Port 2 on a successful network connection.

Table 41 - Configure Serial Port 2 as TCP Client

Step	Description
<i>Navigation Bar</i> Select Configuration	You will see a group of fields under the banner of WLAN Parameters.
<i>Feature Link</i> Select Connection Settings	The wireless interface and security must be configured before configuring the Ethernet settings. A page showing the configuration options for TCP/IP and UDP connections to the device. Configuration of Telnet, HTTP and SSH ports is possible through this page.
Select TCP Port – Serial Port 2	Enter the port on which the target server is listening for TCP connections.
Select TCP Timeout – Serial Port 2	Enter the inactivity timeout in seconds, after which the device will close the open data tunnel on Serial Port 1. The default 0 disables the timeout.
Select TCP Retry Time – Serial Port 2	Enter the period (in seconds) the device should use to retry establishing the TCP connection to the target server.

Step	Description
Select Primary TCP Target Server IP Address – Serial Port 2	Enter the IP address of the primary target server. The address must be in the format: XXX.XXX.XXX.XXX
<i>Optional</i> Select Secondary TCP Target Server IP Address – Serial Port 2	Enter the IP address of the secondary target server. The address must be in the format: XXX.XXX.XXX.XXX This address will be used if the initial attempts to connect to the primary server fail. This field is optional.
Press Commit [Button]	Saves changes to the device.
Press Reload [Button]	Reloads the Connection Settings page.
<i>Feature Link</i> Select Serial Port 2 Settings	The wireless interface and security must be configured before configuring the Ethernet settings. Displays a page showing the serial port configuration, setting the default mode of operation for the serial interface is done in this page.
Select Serial CLI Default Mode	Select Pass from the drop down menu.
Press Commit [Button]	Saves changes to the device.
<i>Optional</i> Press Reload [Button]	Reloads the Serial Port 2 Settings page. Select this if you have further configuration options to change.
<i>Optional</i> Press Restart [Button]	Restarts the device. After the device as rebooted it will attempt to authenticate to the configured network. As long as the network is in range the wireless interface will connect. Once authenticated to the network it the device will attempt to make a TCP connection with primary target server, using the configured port number.

21.0 Installing and Using the Airborne VirtualCOM Driver

B&B Electronics supplies with its serial devices a virtual COM port device driver for the Microsoft Windows operating system. This driver acts as a Virtual COM port for applications requiring the use of a COM port for data communication. The driver redirects serial data to a TCP/IP connection between the host computer and target Airborne™ device.

Installation of the VCOM driver is done using the Airborne Management Center™ (AMC). The following Table 42 identifies the steps to complete the process of installing the VCOM driver for a specific device. Once installed the host system will have additional COM ports through which the system may communicate with the device attached to the serial port on the Airborne™ device.

Table 42 - Install VCOM

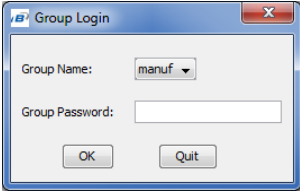
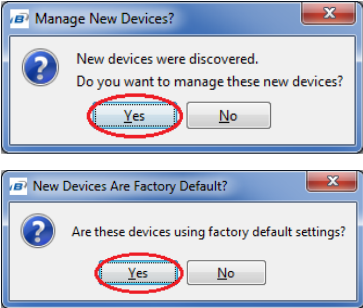
1	<p>Run the Airborne Management System application. This was installed during the CD installation and a menu item will be found in the Airborne folder located in the programs directory of your system.</p> <p>When the application opens the following dialog will be displayed:</p>  <p>The dialog box is titled "Group Login" and contains a "Group Name:" dropdown menu with "manuf" selected, a "Group Password:" text input field, and "OK" and "Quit" buttons.</p> <p>Select Group Name: manuf and enter Group Password: dpac</p>
2	<p>The AMC will load and discover the attached devices. Manage your device.</p>  <p>Two dialog boxes are shown. The first is titled "Manage New Devices?" and asks "New devices were discovered. Do you want to manage these new devices?" with "Yes" and "No" buttons. The "Yes" button is circled in red. The second is titled "New Devices Are Factory Default?" and asks "Are these devices using factory default settings?" with "Yes" and "No" buttons. The "Yes" button is circled in red.</p>

3

Managed devices will show up under the device type heading they belong to. To install a VCOM driver the device MUST have a serial port.

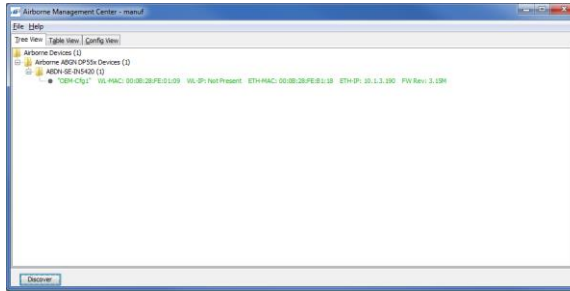

4

The status of the device will move to managed and it will be displayed under the device type/group it belongs too. To install the VCOM driver, right click the target device:

1. Select **Configuration Management**
2. Select **Install VCOM Driver for OEM-Cfg1**

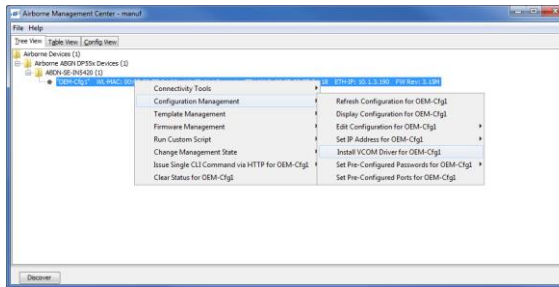

Note: if the port selection box doesn't have any ports listed; cancel the install, close AMC, then restart AMC by right-clicking the icon and clicking "Run as administrator".

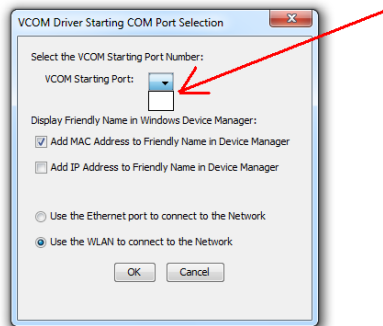

5

The VCOM driver will then be installed. When completed the following message will be seen in the lower right-hand corner.



6

The installed VCOM ports are now available for use.

7

To identify the VCOM ports right click **My Computer**.

Select **Properties**.

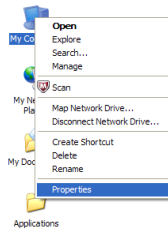

8

Select the **Hardware** tab.

Select the **Device Manager** button.

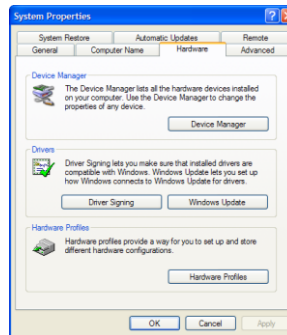

Select the **Ports (COM & LPT)** group and the list of available COM ports will be shown. The VCOM ports will be identified as **Ethernet Serial Port (COMx)**, where **x** will be an integer. This **COMx** reference identifies the VCOM to be used.

Note that if your unit is a dual serial port device, two VCOM ports will have been created.

9

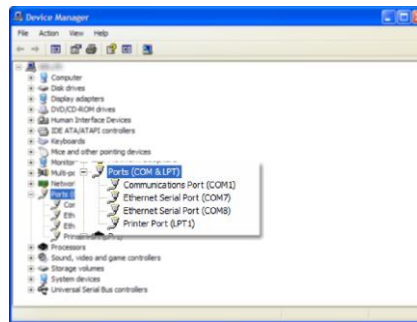

10

To identify which VCOM port is assigned to which device, right click the **Ethernet Serial Port** and select **Properties**.

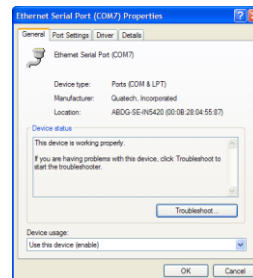

The **Location** label identifies the MAC address of the associated Airborne device.



Do not change the WLAN IP address settings for the Airborne device which is using the VCOM driver. Changing the IP address of the device will cause the VCOM driver not to function. It will need to be reinstalled if this occurs.

22.0 Replacing a Serial Cable

The serial device servers can be configured to act as a cable replacement using either an AdHoc or Infrastructure network. In this application you will need two (2) B&B Electronics Serial device servers. Once configured the two devices will automatically connect and make a virtual serial connection between the two serial ports across the 802.11 network.

To establish the cable replacement one device will be the master and one the slave. It does not matter which end of the serial connection is which. The master initiates the network connection and the slave waits for the master to connect. The following Table 43 and Table 44 identify the required configurations for the Master and Slave. The configuration is for a single serial port, the same configuration can be used with those devices that support two serial connections.

The configurations in Table 43 and Table 44 use an AdHoc network. An infrastructure network can be used as long as static IP configuration is used for the slave device.

Table 43 - Cable Replacement - Slave Configuration

Step	Description
<i>Configure the device to use an AdHoc network</i>	See section 17.2 After the Commit at the end of the configuration press the Reload Button.
<i>Configure the device to use a static IP address on the WLAN interface</i>	See section 19.3 After the Commit at the end of the configuration press the Reload Button.
<i>Configure the device to listen for a connection on the tunnel port</i>	See section 20.2 After the Commit at the end of the configuration press the Reload Button.
<i>Navigation Bar</i> Select Configuration	You will see a group of fields under the banner of Interface and Network Parameters.
<i>Feature Link</i> Select Serial Port Settings	The wireless interface and security must be configured before configuring the Ethernet settings. A page showing the configuration options for TCP/IP and UDP connections to the device. Configuration of Telnet, HTTP and SSH ports is possible through this page.
Select Serial Port Bit Rate	Select the appropriate bit rate to match the serial port the device will be connected to.
Select Parity	Select the parity setting to match the serial port the device will be connected to, from the drop down list.
Select Data Bits	Select the number of data bits to match the serial port the device will be connected to, from the drop down list.
Select Stop Bits	Select the number of stop bits to match the serial port the device will be connected to, from the drop down list.
Select Flow Control	Select the flow control option to match the serial port the device will be connected to, from the drop down list.
<i>Optional</i> Select Serial Assert	Select the option to match the serial port the device will be connected to, from the drop down list. This is only required if software flow control has been selected.
Press Commit [Button]	Saves changes to the device.

Step	Description
Press Reload [Button]	Reloads the WLAN Settings page.
<i>Optional</i> Press Reload [Button]	Reloads the Serial Port Settings page. Select this is you have further configuration options to change.
<i>Optional</i> Press Restart [Button]	Restarts the device. After the device as rebooted it will create an AdHoc network with the name you gave the SSID. As long as the network is in range the wireless interface will connect.

Table 44 - Cable Replacement - Master Configuration

Step	Description
<i>Configure the device to use an AdHoc network</i>	See section 17.2 After the Commit at the end of the configuration press the Reload Button.
<i>Configure the device to use a static IP address on the WLAN interface</i>	See section 19.3 After the Commit at the end of the configuration press the Reload Button.
<i>Configure the device to listen for a connection on the tunnel port</i>	See section 20.2 After the Commit at the end of the configuration press the Reload Button.
<i>Navigation Bar</i> Select Configuration	You will see a group of fields under the banner of Interface and Network Parameters.
<i>Feature Link</i> Select Serial Port Settings	The serial port must be configured to work with the target device. This is a page showing the configuration options for the serial port.
Select Serial Port Bit Rate	Select the appropriate bit rate to match the serial port the device will be connected to.
Select Parity	Select the parity setting to match the serial port the device will be connected to, from the drop down list.
Select Data Bits	Select the number of data bits to match the serial port the device will be connected to, from the drop down list.
Select Stop Bits	Select the number of stop bits to match the serial port the device will be connected to, from the drop down list.
Select Flow Control	Select the flow control option to match the serial port the device will be connected to, from the drop down list.
<i>Optional</i> Select Serial Assert	Select the option to match the serial port the device will be connected to, from the drop down list. This is only required if software flow control has been selected.
Select Serial CLI Default Mode	Select Pass from the drop down menu.
Press Commit [Button]	Saves changes to the device.
Press Reload [Button]	Reloads the WLAN Settings page.

Step	Description
<i>Feature Link</i> Select Connection Settings	<p>The target device configuration must be configured to make sure the master device connects to the correct slave.</p> <p>A page showing the configuration options for TCP/IP and UDP connections to and from the device. Configuration of Telnet, HTTP and SSH ports is possible through this page.</p>
Select TCP Port	<p>This is the target port for the TCP connection on the slave device. This should be set to the listen port assigned during the configuration of the slave. The default for the listen port is 8023.</p>
Select TCP Timeout	<p>This parameter allows the device to close the TCP socket to the slave should the connection be lost. The default of 0 disables the timeout.</p> <p>The timeout setting should be based upon the period of time a connection would not be used. It should at least exceed the worst case of the data period.</p>
Select Primary TCP Target Server IP Address	<p>Enter the static IP address that was given to the slave device during configuration.</p>
Select Outbound Transmit Type	<p>This is the outbound transmission protocol.</p> <p>Set this to TCP from the drop down list.</p>
Press Commit [Button]	<p>Saves changes to the device.</p>
Press Reload [Button]	<p>Reloads the WLAN Settings page.</p>
<i>Optional</i> Press Reload [Button]	<p>Reloads the Serial Port Settings page. Select this is you have further configuration options to change.</p>
<i>Optional</i> Press Restart [Button]	<p>Restarts the device. After the device as rebooted it will create an AdHoc network with the name you gave the SSID. As long as the network is in range the wireless interface will connect.</p>

23.0 Configuring Ethernet Adapter

The ABDx-ER-DP5xx/IN5xxx devices are shipped preconfigured for use as an Ethernet adapter. All that is required is configuration of the WLAN parameters and security protocols; however the following section will cover the full configuration of an Ethernet Device to aid in the installation and deployment of the units.

The Airborne Ethernet adapter (ER) is a fully functional NAT Level 3 router, supporting a public IP address for the WLAN interface and a private network for the attached devices on the Ethernet interface. When configured as a Bridge adapter, it disables routing and bridges all packets between the Ethernet and wireless interfaces.

23.1 Router Functionality

Network Address Translation (NAT) is the process of modifying network address information in datagram packet headers while in transit across a traffic routing device for the purpose of remapping a given address space into another. In the case of a NAT Level 3 device, the modification of the packet headers provides for a translation between a single public IP address (that of the WLAN interface) and the IP address of the devices on the private network (Ethernet interface).

The Airborne Adapter WLAN interface is considered the public address and will be the point of contact on the target network (see Figure 19). This interface supports all the wireless and network authentication requirements including support for WPA2-Enterprise. It can acquire an IP address through both DHCP or user configured static IP. Configuration, association and authentication are handled entirely by the Airborne Bridge and require no interaction from the wired host on the private network.

Figure 19 - Ethernet Bridge Functionality

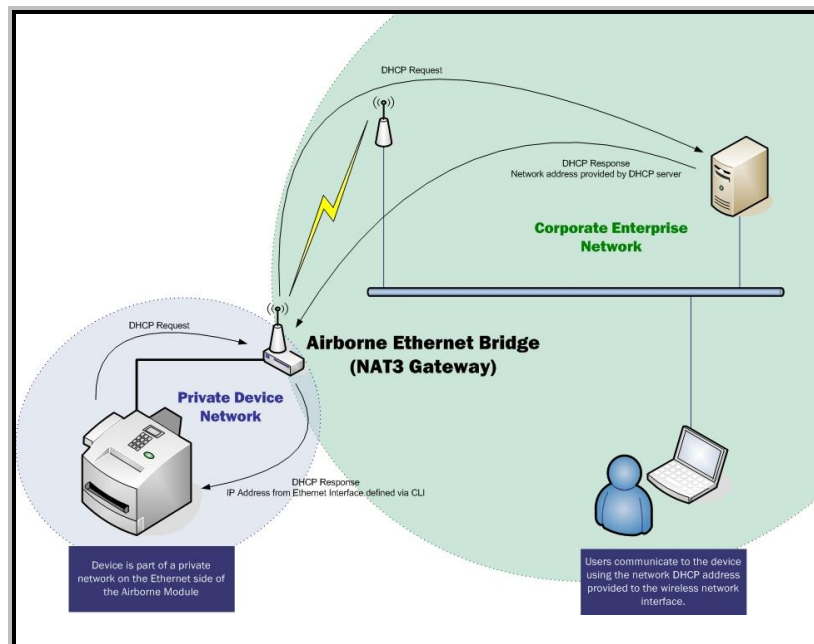

The Private network is the wired interface provided by the bridge. This interface includes a DHCP server and supports dynamic and static IP address assignment. This means any Ethernet client supporting DHCP can be connected to the wired interface without any configuration changes. The private network host can communicate with the Airborne Adapter using the bridges Ethernet IP address on the private network.

The Airborne Ethernet Adapter supports NAT Level 3 and as such provides the following advantages over the more traditional bridge functionality:

- A single network IP address on the public network. This simplifies management of the devices on the network.
- A single point of authentication. The Airborne device handles authentication for the public network, this means a single point of contact for all security interaction, simplifying deployment for the network.
- Zero security footprint on the private network host.
- Support for DHCP and static IP on the private network. This capability allows the host to be shipped without any configuration changes.
- Port forwarding. Allows you to decide if web page, telnet or FTP access should be forwarded to the private network or handled by the Airborne Bridge.
- Plug-n-Play. In most cases all that is required for full functionality is configuration of the wireless interface for the target network. This can be done before deployment to minimize deployment time and complexity.

23.1.1 Public Network Interface

The public network interface is the Airborne Adapter WLAN port. This interface must be configured to associate and authenticate with the target network. Configuration of this interface is covered in section 17.0.

The public address becomes the target address for all accesses to the host device connected to the private network. In the example shown in Figure 20, any device on the public network wanting to communicate with the Host device (IP: 192.168.2.100), would use the IP address 123.45.67.89, the Airborne Ethernet Adapter will forward all traffic to the private address 192.168.2.100.

The network infrastructure will show the MAC and IP address of the Airborne Adapter WLAN interface as the network presence, as a consequence of this all traffic will be identified as being from or to this address.

Figure 20 - Airborne Ethernet Bridge IP Configuration

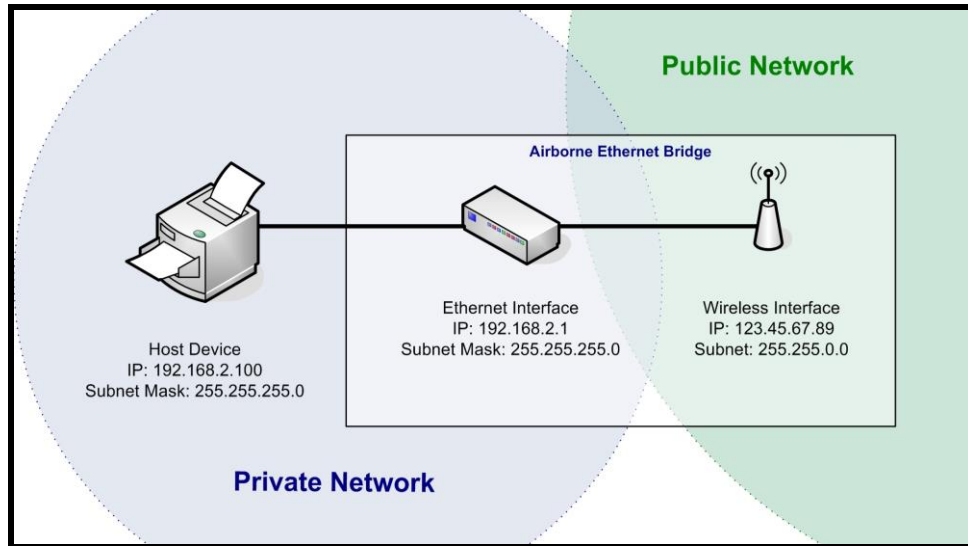

The public network interface supports the Airborne™ discovery protocol and will respond to discovery requests issued on the public network.

23.1.2 Private Network Interface

The private network interface is on the Ethernet port of the Airborne Adapter. The interface supports multiple Ethernet clients with either a static or DHCP sourced IP addresses. The configuration of this interface is covered in Table 45 and Table 46.

Table 45 - Ethernet Adapter interface Configuration - DHCP

Step	Description
<i>Navigation Bar</i> Select Configuration	You will see a group of fields under the banner of WLAN Parameters.
<i>Feature Link</i> Select Ethernet Settings	The wireless interface and security must be configured before configuring the Ethernet settings. A page showing the range of Ethernet options and fields, setting the mode of operation for the Ethernet interface is done in this page.
Select DHCP Server Enabled	Select Enable from drop down menu.
Select Ethernet Role	Select Router from the drop down menu.
Press Commit [Button]	Saves changes to the device.
Press Reload [Button]	Reloads the Ethernet Settings page.

Step	Description
<i>Feature Link</i> Select Network Settings	The wireless interface and security must be configured before configuring the network settings. A page showing the range of network options and fields, for both the WLAN and Ethernet interfaces, is displayed.
Select Ethernet Static IP Address	Enter a valid IP address. This address will be the first IP address leased. If more than one is leased they will increment from this address. The subnet of the address must be different than the WLAN interface subnet. The address must be in the format: XXX.XXX.XXX.XXX This is also the default address all incoming traffic on the WLAN interface is routed to.
Select Ethernet Subnet Mask	Enter the subnet mask for the private network. The mask must be in the format: XXX.XXX.XXX.XXX
Select Ethernet Gateway IP Address	Enter a valid Gateway IP address. This is the Static IP address of the Ethernet interface on the private network. This must be in the same subnet as the Ethernet Static IP Address . The address must be in the format: XXX.XXX.XXX.XXX
Press Commit [Button]	Saves changes to the device.
<i>Optional</i> Press Reload [Button]	Reloads the Network Settings page. Select this is you have further configuration options to change.
<i>Optional</i> Press Restart [Button]	Restarts the device. After the device as rebooted it will attempt to authenticate to the configured network. As long as the network is in range the wireless interface will connect. The Ethernet interface will have leased IP addresses to the Ethernet clients and the Ethernet interface would have taken the Ethernet Gateway IP Address . Access to the public network from the private network is now possible.

Unless your public network is using the default 192.168.2.XX subnet you should not change the Ethernet parameters.

Table 46 - Ethernet Adapter interface Configuration - Static IP

Step	Description
<i>Navigation Bar</i> Select Configuration	You will see a group of fields under the banner of WLAN Parameters.

Step	Description
<i>Feature Link</i> Select Ethernet Settings	The wireless interface and security must be configured before configuring the Ethernet settings. A page showing the range of Ethernet options and fields, setting the mode of operation for the Ethernet interface is done in this page.
Select DHCP Server Enabled	Select Disable from drop down menu.
Select Ethernet Role	Select Router from the drop down menu.
Press Commit [Button]	Saves changes to the device.
Press Reload [Button]	Reloads the Ethernet Settings page.
<i>Feature Link</i> Select Network Settings	The wireless interface and security must be configured before configuring the network settings. A page showing the range of network options and fields, for both the WLAN and Ethernet interfaces, is displayed.
Select Ethernet Static IP Address	Enter the static IP address of the Ethernet client attached to the devices Ethernet port. The subnet of the address must be different than the WLAN interface subnet. The address must be in the format: XXX.XXX.XXX.XXX This is also the default address all incoming traffic on the WLAN interface is routed to.
Select Ethernet Subnet Mask	Enter the subnet mask for the private network that matches the subnet mask on the Ethernet client. The mask must be in the format: XXX.XXX.XXX.XXX
Select Ethernet Gateway IP Address	Enter a valid Gateway IP address. This is the Static IP address of the Ethernet interface on the private network. This must be in the same subnet as the Ethernet Static IP Address , but a different address. The address must be in the format: XXX.XXX.XXX.XXX This address should be entered into the Gateway parameter for the Ethernet clients on the private network.
Press Commit [Button]	Saves changes to the device.
<i>Optional</i> Press Reload [Button]	Reloads the Network Settings page. Select this if you have further configuration options to change.

Step	Description
<i>Optional</i> Press Restart [Button]	Restarts the device. After the device as rebooted it will attempt to authenticate to the configured network. As long as the network is in range the wireless interface will connect. Access to the public network from the private network is now possible.

The private network supports the Airborne™ discovery protocol (UDAP) and will respond to discovery requests.



The subnet for the private network IP addresses (Ethernet Client and Gateway) and public IP address (WLAN), obtained by the module via the wireless interface, **MUST NOT** be the same.

Failure to observe this requirement will result in unpredictable behavior of the adapter.

When attempting to make an out-bound connection to a device on the public network, the public network IP address of the device should be used e.g. In Figure 20 the client with address 192.168.2.100 wants to connect to an FTP server, with the address of 123.45.67.99, on the public network to perform a firmware download. The FTP address that would be used in the **Configuration/Advanced Settings** FTP Server Address or Name would be 123.45.67.99. Note that this is not within the subnet of the Ethernet client, however the NAT router will do the necessary address translations and packet header manipulations to ensure the out-bound and in-bound connections are maintained.

Any traffic between the Airborne Ethernet Adapter's Ethernet interface and Ethernet client, on the private network, will not be broadcast on the public network unless it is directed at the public network.

For most users there will be no modification of the private network settings needed and if the target Ethernet client uses DHCP to obtain an IP address, no change in configuration will be required either.

23.2 Bridge Functionality

When the Adapter is a bridge, the Ethernet and 802.11 interfaces will be bridged together. All packets received on either interface will be forwarded to the other interface. Both interfaces reside on the same network, there are no Private and Public networks. The Ethernet IP configuration is used and the 802.11 IP configuration is ignored. The 802.11 interface will assume the IP address of the first ethernet network client that has traffic sent across the bridge.

When acting as a bridge, the Adapter is still listening on the configured ports for remote access to the Adapter. If traffic to any of the configured ports (http, telnet, ftp, ssh, etc) need to pass through the module, then the ports need to be reconfigured to use non-default settings.

Table 47 - Ethernet Adapter interface Configuration

Step	Description
<i>Navigation Bar</i> Select Configuration	You will see a group of fields under the banner of WLAN Parameters.
<i>Feature Link</i> Select Express Setup	A page showing the range of basic Wireless and Ethernet options and fields.
Select Ethernet Role	Select Router from the drop down menu.
Select Ethernet Static IP Address	Enter the static IP address for the Ethernet network. The IP address should be on the same subnet as the other network clients. The address must be in the format: XXX.XXX.XXX.XXX
Select Ethernet Subnet Mask	Enter the subnet mask for the private network that matches the subnet mask of the Ethernet client and network. The mask must be in the format: XXX.XXX.XXX.XXX
Optional Select Web Server Port	Enter a different value for this port if you want normal Web Server traffic that uses port 80 to pass through the adapter.
Optional Select Telnet Port	Enter a different value for this port if you want normal telnet traffic that uses port 23 to pass through the adapter.
Optional Select Internal FTP Server Listen Port	Enter a different value for this port if you want normal FTP traffic that uses port 21 to pass through the adapter.
Optional Select Secure Shell Server (SSH) Port	Enter a different value for this port if you want normal SSH traffic that uses port 22 to pass through the adapter.
Press Commit [Button]	Saves changes to the device.
Press Restart [Button]	Restarts the device. After the device as rebooted it will attempt to authenticate to the configured wireless network. As long as the network is in range the wireless interface will connect.

23.3 MAC Cloning

If the network is configured to not allow multiple MAC address for the same IP address, MAC address cloning should be enabled. MAC address cloning will cause the WLAN module to adopt the MAC address of the first Ethernet client that it sees traffic from. If the Ethernet client uses DHCP, the module will sniff the DHCP transactions and learn the MAC and IP that the client will use, and adopts them as its own. When in bridge mode, this makes the module look like a “cable replacement” and should be transparent to the network.

24.0 Web Page Overview

The following section highlights the contents of each web page and provides a reference to the associated CLI command. For further explanation of each of the fields please refer to the referenced command in the table (See Airborne Enterprise Command Line Reference Manual). When using CLI command, typing a command followed by a space and a '?' will display help for the command (e.g. "wl-type ?").

Module Status

URL /Status/Module Status

Description The home page when authenticated to the Airborne device, this page provides important information about the device's firmware version, wireless connection status and wireless interface network configuration.

The screenshot shows the B&B Electronics web interface. The top navigation bar includes links for Status, Configuration, Certificates, Network, and Maintenance. The main content area is titled "Module Status" and displays the following information:

Module Firmware Version:	3.15
Radio Firmware Version:	3.1.63.21
Link Status:	Connected
SSID:	AP-D23
MAC Address:	000B28FE0109
BSSID:	000B28FE0112
Transmit Rate (Mb/s):	26
Signal Level (dBm):	-27
Noise Level (dBm):	-96
IP Address:	192.168.10.100
Subnet Mask:	255.255.255.0
Default Gateway:	192.168.10.1
Primary DNS:	10.1.0.5
Secondary DNS:	10.1.0.39
Up Time (Sec):	353

The footer of the page includes the B&B Electronics logo, contact information (1.815.433.5100: phone, 1.800.346.3119: toll free, 1.815.433.5109: sales fax), and a copyright notice: © 2009-2013 B&B Electronics.

Field	CLI Command
Displayed Page	wl-info

Ethernet Status

URL /Status/Ethernet Status

Description Provides important information about the device's firmware version, Ethernet connection status and Ethernet interface network configuration.

The screenshot shows the B&B Electronics web interface. At the top, there is a navigation menu with options: Status, Configuration, Certificates, Network, and Maintenance. The current page is titled "Ethernet Status". On the left side, there is a sidebar with links for Module Status, Ethernet Status (which is highlighted), Ethernet DHCP Clients, Radio Statistics, Ethernet Statistics, and Currently Logged In User. The main content area displays the following information:

Module Firmware Version:	3.15
Link Status:	Connected
Ethernet MAC Address:	000B20FEB118
Link Speed:	100Mb/s
Duplex:	Full
IP Address:	10.1.0.33
Subnet Mask:	255.255.0.0
Default Gateway:	192.168.10.1
Primary DNS:	10.1.0.5
Secondary DNS:	10.1.0.39
Up Time (Sec):	245

At the bottom of the page, there is a footer with links for B&B Electronics, Contact Us, and Technical Support, along with the copyright notice: © 2009-2013 B&B Electronics.

Field	CLI Command
Displayed Page	eth-info

Ethernet DHCP Clients

URL /Status/Ethernet DHCP Clients

Description Displays the IP address issued by the DHCP server to specific MAC addresses.

The screenshot shows the B&B Electronics web interface. The main content area is titled "Ethernet DHCP Clients" and displays a table with the following data:

Client Address	DHCP Address
18:03:73:15:85:12	10.1.3.191

The interface also includes a sidebar with navigation links such as "Module Status", "Ethernet Status", "Ethernet DHCP Clients", "Radio Statistics", "Ethernet Statistics", and "Currently Logged In User". The footer contains the B&B Electronics logo, contact information, and a copyright notice for 2009-2013 B&B Electronics.

Field	CLI Command
Displayed Page	eth-dhcp-clients

Radio Statistics

URL /Status/Radio Statistics

Description Provides information about the packet transmit and receive performance of the wireless interface.

B&B ELECTRONICS *Make The Right Connections*

[Status](#) | [Configuration](#) | [Certificates](#) | [Network](#) | [Maintenance](#) | Device Type: Industrial Ethernet

Radio Statistics

Rx Packets:	816
Rx Bytes:	429879
Rx Errors:	0
Rx Dropped:	0
Rx Overruns:	0
Tx Packets:	1673
Tx Bytes:	102604
Tx Errors:	0
Tx Dropped:	0
Tx Overruns:	0

[B&B Electronics](#) | [Contact Us](#) | [Technical Support](#)
 © 2009-2013 B&B Electronics

Field	CLI Command
Displayed Page	stats <blank> or radio

Ethernet Statistics

URL /Status/Ethernet Statistics

Description Provides information about the packet transmit and receive performance of the Ethernet interface.

B&B ELECTRONICS *Make The Right Connections*

[Status](#) | [Configuration](#) | [Certificates](#) | [Network](#) | [Maintenance](#)
Device Type: Industrial Ethernet

[Module Status](#)

[Ethernet Status](#)

[Ethernet DHCP Clients](#)

[Radio Statistics](#)

[Ethernet Statistics](#)

[Currently Logged In User](#)

[B&B Electronics](#)
 1.815.433.5100 : phone
 1.800.346.3119 : toll free
 1.815.433.5109 : sales fax

Ethernet Statistics

Rx Packets:	3263
Rx Bytes:	285877
Rx Errors:	0
Rx Dropped:	0
Rx Overruns:	0
Tx Packets:	168
Tx Bytes:	68345
Tx Errors:	0
Tx Dropped:	0
Tx Overruns:	0

[B&B Electronics](#) | [Contact Us](#) | [Technical Support](#)
© 2009-2013 B&B Electronics

Field	CLI Command
Displayed Page	stats ethernet

Express Setup

URL /Configuration/Express Setup

Description A page that provides a simplified configuration option set in a single page. Is the default home page when configuring the device for the first time or after a factory reset has been performed.

The screenshot shows the B&B Electronics Express Setup configuration page. The page is titled "Express Setup" and includes a navigation menu with options like Status, Configuration, Certificates, Network, and Maintenance. The main content area is divided into several sections:

- Express Setup:** Discovery OEM Device Name (OEM-Cfg1), Radio Startup Mode (On).
- WLAN Parameters:** WLAN Connection Type (Infrastructure), SSID (AP-D23), WLAN Security Type (WPA2-PSK), WPA / WPA2 Pre Shared Key (PSK).
- Ethernet Parameters:** Ethernet Role (Router), Ethernet DHCP Server Enabled (Enable).
- IP Address Parameters:** WLAN DHCP (Enabled), Ethernet DHCP (Disabled), Ethernet Static IP Address (10.1.3.190), Ethernet Subnet Mask (255.255.0.0), Ethernet Gateway Address (10.1.0.33).

At the bottom of the configuration area, there are buttons for "Commit", "Cancel", and "Defaults". The footer of the page includes "B&B Electronics", "Contact Us", "Technical Support", and a copyright notice "© 2009-2013 B&B Electronics".

Field	CLI Command
Discovery OEM Device Name	name-oem
Radio Startup Mode	radio-on, radio-off
Wireless LAN Connection Type	wl-type
SSID	wl-ssid
Wireless LAN Security Type	wl-security
WEP Key 1	wl-key-1
WPA/WPA2Pre Shared Key (PSK)	pw-wpa-psk
LEAP User Name	user-leap
LEAP Password	pw-leap
PEAP Identity	eap-ident
PEAP Password	eap-password
Ethernet Role	eth-role
Ethernet DHCP Server	eth-dhcp-server
WLAN DHCP	wl-dhcp
Ethernet DHCP	eth-dhcp
WLAN Static IP Address	wl-ip
WLAN Subnet Mask	wl-subnet
Ethernet Static IP Address	eth-ip
Ethernet Subnet Mask	eth-subnet
Ethernet Gateway	eth-gateway

WLAN Settings

URL /Configuration/WLAN Settings

Description Configures the wireless interface settings including network name and type.

WLAN Parameters	Current Values
Radio Startup Mode:	On <input type="button" value="ⓘ"/>
WLAN Connection Type:	Infrastructure <input type="button" value="ⓘ"/>
SSID:	AP-D23 <input type="button" value="ⓘ"/>
WLAN TX Power (dBm):	15 dBm <input type="button" value="ⓘ"/>
Maximum Wireless Data Rate:	Auto <input type="button" value="ⓘ"/>
Use Fixed Data Rate:	Disabled <input type="button" value="ⓘ"/>
WLAN Region:	United States (US) <input type="button" value="ⓘ"/>
Preferred Radio Band:	Auto <input type="button" value="ⓘ"/>
WLAN Maximum Retries:	13 <input type="button" value="ⓘ"/>
WLAN RTS Threshold:	0 <input type="button" value="ⓘ"/>

Field	CLI Command
Radio Startup Mode	radio-on, radio-off
Wireless LAN Connection Type	wl-type
SSID	wl-ssid
Wireless Transmit Power	wl-tx-power
Maximum Wireless Data Rate	wl-rate
Use Fixed Data Rate	wl-fixed-rate
Wireless LAN Region	wl-region
802.11 Band	wl-band-pref
Wireless Max Retries on TX	wl-max-retries
Wireless RTS Threshold	wl-rts-threshold

WLAN Security Settings

URL /Configuration/WLAN Security Settings

Description Configures the security settings for the target network.

<p>WLAN Security Parameters Current Values</p> <p>WLAN Security Type: <input type="text" value="WEP 128"/> ⓘ</p> <p>Authentication Type: <input type="text" value="Auto"/> ⓘ</p> <p>WEP Settings</p> <p>Default WEP Key: <input type="text" value="1"/> ⓘ</p> <p>WEP Key 1: <input type="text"/> ⓘ</p> <p>WEP Key 2: <input type="text"/> ⓘ</p> <p>WEP Key 3: <input type="text"/> ⓘ</p> <p>WEP Key 4: <input type="text"/> ⓘ</p> <p><input type="button" value="Commit"/> <input type="button" value="Cancel"/> <input type="button" value="Defaults"/></p>	
<p>WLAN Security Parameters Current Values</p> <p>WLAN Security Type: <input type="text" value="WPA-LEAP"/> ⓘ</p> <p>Authentication Type: <input type="text" value="Auto"/> ⓘ</p> <p>WPA / WPA2 Settings</p> <p>WPA Protocol Version: <input type="text" value="Auto"/> ⓘ</p> <p>LEAP Settings</p> <p>LEAP User Name: <input type="text" value="dpac"/> ⓘ</p> <p>LEAP Password: <input type="text"/> ⓘ</p> <p><input type="button" value="Commit"/> <input type="button" value="Cancel"/> <input type="button" value="Defaults"/></p>	
<p>WLAN Security Parameters Current Values</p> <p>WLAN Security Type: <input type="text" value="WPA2-PSK"/> ⓘ</p> <p>Authentication Type: <input type="text" value="Auto"/> ⓘ</p> <p>WPA / WPA2 Settings</p> <p>WPA / WPA2 Pre Shared Key (PSK): <input type="text"/> ⓘ</p> <p><input type="button" value="Commit"/> <input type="button" value="Cancel"/> <input type="button" value="Defaults"/></p>	
<p>WLAN Security Parameters Current Values</p> <p>WLAN Security Type: <input type="text" value="PEAP"/> ⓘ</p> <p>Authentication Type: <input type="text" value="Auto"/> ⓘ</p> <p>WPA / WPA2 Settings</p> <p>WPA Protocol Version: <input type="text" value="Auto"/> ⓘ</p> <p>EAP Settings</p> <p>Basic/Advanced Settings: <input type="text" value="Basic"/> ⓘ</p> <p>EAP Identity: <input type="text"/> ⓘ</p> <p>EAP Password: <input type="text"/> ⓘ</p> <p>CA Certificate File Name: <input type="text"/> ⓘ</p> <p><input type="button" value="Commit"/> <input type="button" value="Cancel"/> <input type="button" value="Defaults"/></p>	
<p>WLAN Security Parameters Current Values</p> <p>WLAN Security Type: <input type="text" value="TLS"/> ⓘ</p> <p>Authentication Type: <input type="text" value="Auto"/> ⓘ</p> <p>WPA / WPA2 Settings</p> <p>WPA Protocol Version: <input type="text" value="Auto"/> ⓘ</p> <p>EAP Settings</p> <p>Basic/Advanced Settings: <input type="text" value="Basic"/> ⓘ</p> <p>EAP Identity: <input type="text"/> ⓘ</p> <p>CA Certificate File Name: <input type="text"/> ⓘ</p> <p>Client Certificate File Name: <input type="text"/> ⓘ</p> <p>Private Key File Name: <input type="text"/> ⓘ</p> <p>Private Key File Password: <input type="text"/> ⓘ</p> <p><input type="button" value="Commit"/> <input type="button" value="Cancel"/> <input type="button" value="Defaults"/></p>	

WLAN Security Parameters	Current Values
WLAN Security Type:	TTLIS ⓘ
Authentication Type:	Auto ⓘ
WPA / WPA2 Settings	
WPA Protocol Version:	Auto ⓘ
EAP Settings	
Basic/Advanced Settings:	Basic ⓘ
EAP Identity:	<input type="text"/> ⓘ
EAP Password:	<input type="password"/> ⓘ
EAP Anonymous Identity:	<input type="text"/> ⓘ
EAP Phase 2 String:	<input type="text"/> ⓘ
CA Certificate File Name:	<input type="text"/> ⓘ
<input type="button" value="Commit"/> <input type="button" value="Cancel"/> <input type="button" value="Defaults"/>	

WLAN Security Parameters	Current Values
WLAN Security Type:	WPA-FAST ⓘ
Authentication Type:	Auto ⓘ
EAP Settings	
Basic/Advanced Settings:	Basic ⓘ
EAP Identity:	<input type="text"/> ⓘ
EAP Password:	<input type="password"/> ⓘ
CA Certificate File Name:	<input type="text"/> ⓘ
EAP-FAST Settings	
EAP-FAST Provisioning Type:	Authenticated ⓘ
Maximum Number of EAP-FAST Servers:	10 ⓘ
<input type="button" value="Commit"/> <input type="button" value="Cancel"/> <input type="button" value="Defaults"/>	

Field	CLI Command
Wireless LAN Security Type	wl-security
Authentication Type	wl-auth
Default WEP Key	wl-def-key
WEP Key 1 - 4	wl-key-1, wl-key-2, wl-key-3, wl-key-4
WPA Protocol Version	wl-wpa-format
LEAP User Name	user-leap
LEAP Password	pw-leap
WPA/WPA2 Pre Shared Key (PSK)	pw-wpa-psk
EAP Identity	eap-ident
EAP Password	eap-password
EAP Anonymous Identity	eap-anon-ident
EAP Phase String 1	eap-phase1
EAP Phase String 2	eap-phase2
EAP Subject Match String	subject-match
EAP Subject Match 2 String	subject-match2
EAP Alternate Subject Match String	alt-subject-match
EAP Alternate Subject Match 2 String	alt-subject-match2
CA Certificate File Name	ca-cert-filename
CA Certificate 2 File Name	ca-cert2-filename
Client Certificate File Name	client-cert-filename
Client Certificate 2 File Name	client-cert2-filename
Private Key File Name	priv-key-filename
Private Key File Password	priv-key-password
Private Key 2 File Name	priv-key2-filename
Private Key File 2 Password	priv-key2-password
DH Parameter File Name	dh-param-filename
DH Parameter 2 File Name	dh-param2-filename
EAP-FAST Provisioning Type	eap-fast-provisioning
Maximum Number of EAP-FAST Servers	eap-fast-max-pac-list

Network Settings

URL /Configuration/Network Settings

Description Configures the wireless and Ethernet interface network settings including DHCP, static IP and fall back configurations.

Network Parameters	Current Values
WLAN Specific Settings	
WLAN DHCP:	Enabled
WLAN DHCP Client Name:	AirborneFE0109
WLAN DHCP Acquire Limit:	90
WLAN DHCP Fallback:	Enabled
WLAN Fallback to Last DHCP IP Address:	Disabled
WLAN Fallback IP Address:	192.168.10.1
WLAN Fallback Subnet Mask:	255.255.255.0
WLAN Fallback Gateway IP Address:	0.0.0.0
Ethernet Specific Settings	
Ethernet DHCP:	Disabled
Ethernet DHCP Client Name:	AirborneFEB118
Ethernet Static IP Address:	10.1.3.190
Ethernet Subnet Mask:	255.255.0.0
Ethernet Gateway IP Address:	10.1.0.33
Common Settings	
DNS Server1 IP Address:	0.0.0.0
DNS Server2 IP Address:	0.0.0.0
WINS Server1 IP Address:	0.0.0.0
WINS Server2 IP Address:	0.0.0.0
DHCP Request Retransmission Mode:	Exponential Interval
DHCP Request Retransmission Interval:	15
<input type="button" value="Commit"/> <input type="button" value="Cancel"/> <input type="button" value="Defaults"/>	

Field	CLI Command
WLAN DHCP	wl-dhcp
WLAN DHCP Client Name	wl-dhcp-client
WLAN Static IP Address	wl-ip
WLAN Subnet Mask	wl-subnet
WLAN Gateway IP Address	wl-gateway
WLAN DHCP Acquire Limit	wl-dhcp-acqlimit
WLAN DHCP Fallback	wl-dhcp-fb
WLAN Fallback to Last DHCP IP Address	wl-dhcp-fbauto
WLAN Fallback IP Address	wl-dhcp-fbip
WLAN Fallback Subnet Mask	wl-dhcp-fbsubnet
WLAN Fallback Gateway IP Address	wl-dhcp-fbgateway
Save Last WLAN DHCP IP Address as Fallback IP Addresses	wl-dhcp-fbper
Ethernet DHCP	eth-dhcp
Ethernet DHCP Client Name	eth-dhcp-client
Ethernet DHCP Acquire Limit	eth-dhcp-acqlimit
Ethernet Static IP Address	eth-ip
Ethernet Subnet Mask	eth-subnet

Ethernet Gateway IP Address	eth-gateway
Ethernet DHCP Fallback	eth-dhcp-fb
Ethernet Fallback to Last DHCP IP Address	eth-dhcp-fbauto
Ethernet Fallback IP Address	eth-dhcp-fbip
Ethernet Fallback Subnet Mask	eth-dhcp-fbsubnet
Ethernet Fallback Gateway IP Address	eth-dhcp-fbgateway
Save Last Ethernet DHCP IP Address as Fallback IP Addresses	eth-dhcp-fbper
DNS Server1/2 IP Address	dns-server1, dns-server2
WINS Server1/2 IP Address	wins-server1, wins-server2
WLAN DHCP Request Retransmission Mode	wl-dhcp-mode
WLAN DHCP Request Retransmission Interval	wl-dhcp-interval
Ethernet DHCP Request Retransmission Mode	eth-dhcp-mode
Ethernet DHCP Request Retransmission Interval	eth-dhcp-interval

Serial Port Settings

URL /Configuration/Serial Port Settings

Description Configures the serial port settings on the primary serial port.

Serial Port Parameters	Current Values
Serial CLI Default Mode:	CLI
Serial Port Bit Rate:	9600
Parity:	None
Data Bits:	8
Stop Bits:	1
Flow Control:	None
Input Buffer Flush Size:	1460
Serial Escape Mode:	On
Network CLI Escape Mode:	On
Escape String:	7E7E7E6473
Serial Interface Type:	RS-232

Field	CLI Command
Serial CLI Default Mode	serial-default, serial-default-p1
Serial Port Bit Rate	bit-rate, parity-p1
Parity	parity, parity-p1
Data Bits	data-bits, data-bits-p1
Stop Bits	stop-bit, stop-bit-p1
Flow Control	flow, flow-p1
Input Buffer Flush Size	input-size, input-size-p1
Serial Escape Mode	esc-mode-serial, esc-mode-serial-p1
Network CLI Escape Mode	esc-mode-lan, esc-mode-lan-p1
Escape String	esc-str, esc-str-p1
Serial Interface Type	intf-type

Serial Port 2 Settings

URL /Configuration/Serial Port 2 Settings

Description Configures the serial port settings on the secondary serial port.

Serial Port 2 Parameters	Current Values
Serial CLI Default Mode:	CLI
Serial Port Bit Rate:	9600
Parity:	None
Data Bits:	8
Stop Bits:	1
Flow Control:	None
Input Buffer Flush Size:	1460
Serial Escape Mode:	On
Network CLI Escape Mode:	On
Escape String:	7E7E7E6473
Serial Interface Type:	RS-232

Commit Cancel Defaults

Field	CLI Command
Serial CLI Default Mode	serial-default-p2
Serial Port Bit Rate	parity-p2
Parity	parity-p2
Data Bits	data-bits-p2
Stop Bits	stop-bit-p2
Flow Control	flow-p2
Serial Assert	serial-assert-p2
Input Buffer Flush Size	input-size-p2
Serial Escape Mode	esc-mode-serial-p2
Network CLI Escape Mode	esc-mode-lan-p2
Escape String	esc-str-p2
Serial Interface Type	intf-type



Serial port 2 cannot run in RS-485 mode and will assume RS-422 mode even if it is set to RS-485 mode. Serial port 2 cannot run half duplex and must have a 4 wire connection.

Connection Settings

URL /Configuration/Connection Settings

Description Configures the data tunnel and network port settings for both serial ports. Includes management of port access and service availability.

Connection Parameters	Current Values
Serial Port 1 Connection Settings	
Outbound Transmit Type:	Both <input type="checkbox"/>
Primary TCP Target Server IP Address:	192.168.10.102 <input type="checkbox"/>
Secondary TCP Target Server IP Address:	0.0.0.0 <input type="checkbox"/>
TCP Port:	8023 <input type="checkbox"/>
TCP Timeout:	0 <input type="checkbox"/>
TCP Retry Time:	60 <input type="checkbox"/>
UDP Target Server IP Address:	0.0.0.0 <input type="checkbox"/>
UDP Port:	8023 <input type="checkbox"/>
UDP Receive Port:	8023 <input type="checkbox"/>
UDP Transmit Mode:	Disable <input type="checkbox"/>
Tunnel Enabled:	Disabled <input type="checkbox"/>
Serial Port 2 Connection Settings	
Outbound Transmit Type - Serial Port 2:	Both <input type="checkbox"/>
Primary TCP Target Server IP - Serial Port 2:	0.0.0.0 <input type="checkbox"/>
Secondary TCP Target Server IP - Serial Port 2:	0.0.0.0 <input type="checkbox"/>
TCP Port - Serial Port 2:	2571 <input type="checkbox"/>
TCP Timeout - Serial Port 2:	0 <input type="checkbox"/>
TCP Retry Time - Serial Port 2:	60 <input type="checkbox"/>
UDP Target Server IP - Serial Port 2:	0.0.0.0 <input type="checkbox"/>
UDP Port - Serial Port 2:	8024 <input type="checkbox"/>
UDP Receive Port - Serial Port 2:	8024 <input type="checkbox"/>
UDP Transmit Mode - Serial Port 2:	Disable <input type="checkbox"/>
Tunnel Enabled - Serial Port 2:	Disabled <input type="checkbox"/>
Port Settings	
HTTP Port Accessible via Wireless:	Enabled <input type="checkbox"/>
Web Server Port:	80 <input type="checkbox"/>
Default Web Page:	index.html <input type="checkbox"/>
Telnet Port Accessible via Wireless:	Enabled <input type="checkbox"/>
Telnet Port:	23 <input type="checkbox"/>
Telnet Timeout:	0 <input type="checkbox"/>
Internal FTP Server Enabled:	Enabled <input type="checkbox"/>
Internal FTP Server Listen Port:	21 <input type="checkbox"/>
SSH Port Accessible via Wireless:	Enabled <input type="checkbox"/>
Secure Shell Server Port:	22 <input type="checkbox"/>
Common Settings	
Connect LED Mode:	TCP <input type="checkbox"/>
TCP Max Retries:	5 <input type="checkbox"/>
Wireless UDAP Discovery Enabled:	Enabled <input type="checkbox"/>
Ethernet UDAP Discovery Enabled:	Enabled <input type="checkbox"/>





Field	CLI Command
Outbound Transmit Type	wl-xmit-type, wl-xmit-type-p1
Primary TCP Target Server IP Address	wl-tcp-ip, wl-tcp-ip-p1
Secondary TCP Target Server IP Address	wl-tcp-ip2, wl-tcp-ip2-p1
TCP Port	wl-tcp-port, wl-tcp-port-p1
TCP Timeout	wl-tcp-timeout, wl-tcp-timeout-p1

TCP Retry Time	wl-retry-time, wl-retry-time-p1
Tunnel Enabled	wl-tunnel, wl-tunnel-p1
Tunnel Port	wl-tunnel-port, wl-tunnel-port-p1
Tunnel Mode	wl-tunnel-mode, wl-tunnel-mode-p1
UDP Target Server IP Address	wl-udp-ip, wl-udp-ip-p1
UDP Port	wl-udp-port, wl-udp-port-p1
UDP Receive Port	wl-udp-rxport, wl-udp-rxport-p1
UDP Transmit Mode	wl-udp-xmit, wl-udp-xmit-p1
Outbound Transmit Type – Serial Port 2	wl-xmit-type-p2
Primary TCP Target Server IP Address – Serial Port 2	wl-tcp-ip-p2
Secondary TCP Target Server IP Address – Serial Port 2	wl-tcp-ip2-p2
TCP Port – Serial Port 2	wl-tcp-port-p2
TCP Timeout – Serial Port 2	wl-tcp-timeout-p2
TCP Retry Time – Serial Port 2	wl-retry-time-p2
UDP Target Server IP Address – Serial Port 2	wl-udp-ip-p2
UDP Port – Serial Port 2	wl-udp-port-p2
UDP Receive Port – Serial Port 2	wl-udp-rxport-p2
UDP Transmit Mode – Serial Port 2	wl-udp-xmit-p2
Tunnel Enabled – Serial Port 2	wl-tunnel-p2
Tunnel Port – Serial Port 2	wl-tunnel-port-p2
Tunnel Mode – Serial Port 2	wl-tunnel-mode-p2
HTTP Port Accessible via Wireless	http-port
Web Server Port	wl-http-port
Telnet Port Accessible via Wireless	telnet-port
Telnet Port	wl-telnet-port
Telnet Timeout	wl-telnet-timeout
Internal FTP Server Enabled	ftp-server
Internal FTP Server Listen Port	ftp-server-listen-port
SSH Port Accessible via Wireless	ssh-port
Secure Shell Server Port	wl-ssh-port
Connect LED Mode	wl-con-led
TCP Max Retries	tcp-retries
Wireless UDAP Discovery Enabled	wl-udap
Ethernet UDAP Discovery Enabled	eth-udap

Ethernet Settings

URL /Configuration/Ethernet Settings

Description Configures the Ethernet interface for AirborneDirect™ Ethernet devices.

Ethernet Parameters	Current Values
Ethernet Role:	Router 
DHCP Server Enabled:	Enable 
MAC Cloning:	Disable 
Ethernet Port Speed/Duplex:	Autonegotiate 

Field	CLI Command
Ethernet Role	eth-role
DHCP Server Enabled	eth-dhcp-server
MAC Cloning	wl-mac-clone
Ethernet Port Speed/Duplex	eth-mode

Wireless Routing Settings

URL /Configuration/Wireless Routing Settings

Description Configures the port forwarding routing rules for the wireless interface.

Wireless Routing Parameters	Current Values					
Wireless Routing Default:	FORWARD 					
Wireless Routing Rule:	Protocol: TCP 	Port: 8080	Action: FORWARD 	Dest IP: 192.168.10.100	Port: 80	Remove: 
<input type="button" value="Add rule"/> <input type="button" value="Commit"/> <input type="button" value="Cancel"/>						

Field	CLI Command
Wireless Routing Default	wl-route-default
Add rule [Button]	wl-route

Additional details on using the wl-route command:

Usage: wl-route [tcp|udp|icmp|bcst|all] [port xxx] forward|drop|relay [xxx.xxx.xxx.xxx:xxx]

Sets up a specific rule for incoming wireless traffic.

The tcp|udp|icmp|bcst|all option selects the protocol for this rule.

The port option defines the port number for this rule. You cannot set the port option if the protocol is icmp or all.



The drop option will cause traffic matching the protocol and port specifications to be dropped. In this case, any parameters following the drop option will be ignored. The forward option will cause traffic to be forwarded to the ethernet interface, and requires another parameter to define the destination IP address and port. The other parameter is formatted as xxx.xxx.xxx.xxx:port.

The relay option can only be used if the protocol is bcst and will cause UDP traffic with destination address 255.255.255.255 received on the specified port to be relayed to the ethernet interface.



For example, the command wl-route tcp port 80 forward 192.168.2.101:8080 will cause all tcp port 80 traffic received on the wireless interface to be forwarded to IP address 192.168.2.101, port 8080 on the Ethernet interface.

wl-route with no parameters will display the current set of wireless routing rules in the order that they will be applied to incoming traffic.

Ethernet Routing Settings

URL /Configuration/Ethernet Routing Settings

Description Configures the firewall routing rules for the Ethernet interface..

Ethernet Routing Parameters	Current Values
Ethernet Routing Default:	ACCEPT 
Ethernet Routing Rule:	Protocol: TCP  IP: 192.168.1.100 Port: 2020 Action: ACCEPT  Remove: <input type="checkbox"/>
<input type="button" value="Add rule"/>	<input type="button" value="Commit"/> <input type="button" value="Cancel"/>

Field	CLI Command
Ethernet Routing Default	eth-route-default
Add rule [Button]	eth-route

Advanced Settings

URL /Configuration/Advanced Settings

Description Configures the advanced configuration settings for the unit, including authentication usernames and passwords, configuration of SSH, power save setup, GPIO, indicator LED and FTP settings.

Advanced Parameters	Current Values
Version / User Management	
OEM Defined Version String:	oemverstr
Discovery Manufacturer Device Name:	DPAC-Airborne-IndustrialE
Discovery OEM Device Name:	OEM-Cfg1
Discovery Device Name:	Device
Administrator Password:	<input type="password"/>
Manufacturing User Name:	dpac
Manufacturing Password:	<input type="password"/>
OEM User Name:	oem
OEM Password:	<input type="password"/>
CFG User Name:	cfg
CFG Password:	<input type="password"/>
Regular User Name:	user
Regular User Password:	<input type="password"/>
Encrypt Wireless Keys:	Disabled
Protect the OEM Configuration:	Disabled
Authorization Level Settings	
Minimum Authorization Level for Reset To Factory Defaults:	CFG Level User
Minimum Authorization Level for Radio Off:	CFG Level User
Minimum Authorization Level for Radio On:	CFG Level User
SSH Settings	
SSH Default User Name:	<input type="text"/>
SSH Default Password:	<input type="password"/>
SSH Keysize (evenly divisible by 8):	1024
Power Save Settings	
Module Power Save Mode:	Active
Serial Port 1 Inactivity Timer:	0
Serial Port 2 Inactivity Timer:	0
Radio Startup Mode:	On
FTP Settings	
FTP Server IP Address or Name:	<input type="text"/>
FTP User Name:	<input type="text"/>
FTP Password:	<input type="password"/>
FTP Server Path:	<input type="text"/>
FTP File Name:	<input type="text"/>
System Time Settings	
Timezone Name:	EST
Timezone Offset:	-5:00
Daylight Saving Time Adjustment:	Enabled
Daylight Saving Time Name:	EDT
Daylight Saving Time Offset:	-4:00
Daylight Saving Time Starting Week:	Second
Daylight Saving Time Starting Day:	Sunday
Daylight Saving Time Starting Month:	March
Daylight Saving Time Ending Week:	First
Daylight Saving Time Ending Day:	Sunday
Daylight Saving Time Ending Month:	November
NTP Server IP Address or Name:	pool.ntp.org
NTP Sync at Startup:	Disabled
NTP Refresh Interval:	0

cont.

WLAN Specific Settings	
Antenna Mode:	Antenna 2 Only
Speedlink Roaming:	Enabled
Beacons Missed Before Roaming:	6
Association Retry Count:	3
Association Backoff Time (msec):	10000
ARP Staleout Time:	120
ARP Reachable Time:	120
Use Directed Probes:	Disabled
Lost Association Link Timeout:	1
Startup Options	
Startup Message Mode:	Disabled
Startup Message Text:	Ready
DHCP Vendor Class ID Strings	
WLAN DHCP Vendor Class ID String:	<input type="text"/>
Ethernet DHCP Vendor Class ID String:	<input type="text"/>
LED / GPIO Settings	
I/O Port F Bit Direction:	0xFF
I/O Port F Internal Pullup Resistor:	0xFF
I/O Port G Bit Direction:	0xFF
I/O Port G Internal Pullup Resistor:	0xFF
Enable LED Signal Strength Meter:	Disabled
Enable POST LED:	Enabled
Enable RF_LINK LED:	Enabled
Enable WLN_CFG LED:	Enabled
Enable CONN LED:	Enabled
Other Advanced Settings	
Enable Echo for Telnet Sessions:	Enabled
UDP Server Ping:	Disabled

Field	CLI Command
OEM Defined Version String	
Discovery Manufacturer Device Name	name-manuf
Discovery OEM Device Name	name-oem
Discovery Device Name	name-device
Administrator Password	pw-root
Manufacturing User Name	user-manuf
Manufacturing Password	pw-manuf
OEM User Name	user-oem
OEM Password	pw-oem
CFG User Name	user-cfg
CFG Password	pw-cfg
Regular User Name	user
Regular User Password	pw
Encrypt Wireless Keys	cfg-encrypt
OEM Configuration Protect	cfg-oem-protect
Minimum Authorization Level for Reset	auth-level reset
Minimum Authorization Level for Radio off	auth-level radio-off
Minimum Authorization Level for Radio on	auth-level radio-on
SSH Default User	ssh-default-user
SSH Default Password	ssh-default-password
SSH Keysize (evenly divisible by 8)	ssh-keysize
Module Power Save Mode	pm-mode

Serial Port 1 Inactivity Timer	wl-sleep-timer, wl-sleep-timer-p1
Serial Port 2 Inactivity Timer	wl-sleep-timer-p2
Radio Startup Mode	radio-startup
FTP Server IP Address or Name	ftp-server-address
FTP User Name	ftp-user
FTP Password	ftp-password
FTP Server Path	ftp-server-path
FTP Filename	ftp-filename
Timezone Name	timezone-name
Timezone Offset	timezone-offset
Daylight Saving Time Adjustment	daylight-saving-time
Daylight Saving Time Name	daylight-saving-name
Daylight Saving Time Offset	daylight-saving-offset
Daylight Saving Time Starting Week	daylight-saving-startweek
Daylight Saving Time Starting Day	daylight-saving-startday
Daylight Saving Time Starting Month	daylight-saving-startmonth
Daylight Saving Time Ending Week	daylight-saving-stopweek
Daylight Saving Time Ending Day	daylight-saving-stopday
Daylight Saving Time Ending Month	daylight-saving-stopmonth
NTP Server IP Address or Name	ntp-server-address
NTP Sync at Startup	ntp-startup-sync
NTP Refresh Interval	ntp-refresh-interval
Antenna Mode	wl-ant
Speedlink Roaming	speedlink
Beacons Missed Before Roaming	wl-beacons-missed
Association Retry Count	wl-assoc-retries
Association Backoff Time (msec)	wl-assoc-backoff
ARP Staleout Time	arp-staleout-time
ARP Reachable Time	arp-reachable-time
Use Directed Probes	wl-specific-scan
Lost Association Link Timeout	wl-link-timeout
Startup Message Mode	startup-msg
Startup Message Text	startup-text
WLAN DHCP Vendor Class ID String	wl-dhcp-vendorid
Ethernet DHCP Vendor Class ID String	eth-dhcp-vendorid
I/O Port F Bit Direction	io-dir-f
I/O Port F Internal Pullup Resistor	io-pullup-f
I/O Port G Direction	io-dir-g
I/O Port G Internal Pullup Resistor	io-pullup-g
Enable LED Signal Strength Meter	led-mode
Enable POST LED	post-led
Enable RF_LINK LED	rf-link-led
Enable WLN_CFG LED	wln-cfg-led
Enable CONN LED	conn-led
Enable Echo for Telnet Sessions	telnet-echo
UDP Server Ping	wl-udp-ping

Upload Configuration File

URL /Configuration/Upload Configuration File

Description Allows user, OEM or encrypted configuration files to be uploaded to the device.

Upload a Configuration File to the Module

Select a Configuration File to upload and save on the module:

Select the destination filename:

- User Configuration
 Encrypted Configuration
 OEM Configuration

Field	CLI Command
Upload Configuration [button]	put-cfg
User Config	put-cfg user_config.txt
Encrypted Configuration	put-cfg user_enc_config.uue
OEM Configuration	put-cfg oem_config.txt

List Configuration File

URL /Configuration/List Configuration File

Description Displays a list of the configuration files saved to the device.

Configuration File Listing

```
timezone.sh      42 bytes
user_config.txt  523 bytes
  2 Files      565 bytes
131072 bytes free
```

Field	CLI Command
Displayed Page	list-cfg

Delete Configuration File

URL /Configuration/Delete Configuration File

Description Allows configuration files saved to the device to be deleted.

Delete a Configuration File From Flash

Choose a Configuration File to Delete:

Choose a Configuration File...

Choose a Configuration File...
timezone.sh
user_config.txt

Field	CLI Command
Delete File [Button]	del-cfg

Active Configuration

URL /Configuration/Active Configuration

Description Displays the current configuration settings being used by the device.

Active Configuration

```
#/bin/gtsh
# /var/tmp/active_config.txt
#
ver-fw 1.40E
ver-oemverstr
user-leap dpac
name-manuf DPAC.Airborne-IndustrialE
name-oem OEM.Cfg1
name-device Device
pm-mode active
esc-str 7E7E7E6473
esc-mode-serial on
esc-mode-lan on
serial-default cli
intf-type rs232
bit-rate 9600
data-bits 8
parity n
flow n
input-size 0x05B4
serial-assert xon
stop-bit 1
io-dir-f 0xFF
io-dir-g 0xFF
io-pullup-f 0xFF
io-pullup-g 0xFF
wi-htp-port 0x0050
wi-telnet-port 0x0017
wi-telnet-timeout 0x00000000
wi-htp-def-index.html
```

Field	CLI Command
Displayed Page	cfg-dump active

User Configuration

URL /Configuration/User Configuration

Description Displays the contents of the user_config.txt configuration file.

User Configuration

```
#!/bin/qsh
# /var/etc/config/user_config.txt
#
name-oem Quatech_DP501
```

Field	CLI Command
Displayed Page	cfg-dump user

OEM Configuration

URL /Configuration/OEM Configuration

Description Displays the contents of the oem_config.txt configuration file.

OEM Configuration

```
#!/bin/gtsh
# /var/etc/config/user_config.txt
#
wl-ssid Cisco1100WPA
wl-security wpa-psk
wl-route-default forward
eth-route-default accept
```

Field	CLI Command
Displayed Page	oem-config oem

Factory Configuration

URL /Configuration/Factory Configuration

Description Displays the factory configuration settings. These are the default settings delivered from the B&B Electronics factory.

Factory Configuration

```

#!/bin/qsh
# /etc/factory_config_ie.txt
ver oemverstr
user.manuf dpac
user.oem oem
user.cfg cfg
user user
user.leap dpac
name.manuf DPAC-Airborne-IndustrialE
name.oem OEM.Cfg1
name.device Device
pm.mode active
esc.str 7E7E7E6473
esc.mode.serial on
esc.mode.lan on
serial.default cli
intf.type rs232
bit.rate 9600
data.bits 8
parity n
flow n
input.size 0x05B4
serial.assert xon
stop.bit 1
io.dir.f 0xFF
io.dir.g 0xFF
io.pullup.f 0xFF
io.pullup.g 0xFF
wl.http.port 0x0050
wl.telnet.port 0x0017
  
```

Field	CLI Command
Displayed Page	cfg-dump factory

WPA Configuration

URL /Configuration/WPA Configuration

Description Displays the current security configuration settings being used by the device.

WPA Configuration

```
#
# /var/tmp/wpa_supplicant.conf
#

ctrl_interface=/var/run/wpa_supplicant
eapol_version=1
ap_scan=1
fast_reauth=1
assoc_retries=3
assoc_backoff=10
network={
ssid="Cisco1100WPA"
scan_ssid=1
mode=0
key_mgmt=WPA-PSK
proto=WPA
pairwise=TKIP
group=TKIP
}
```

Field	CLI Command
Displayed Page	cfg-dump wpa

List Certificates

URL /Certificates/List Certificates

Description Displays a list of the certificates saved to the device. This is the home page for the Certificates link.

B&B ELECTRONICS *Make The Right Connections*

[Status](#)
[Configuration](#)
[Certificates](#)
[Network](#)
[Maintenance](#)
Device Type: Industrial Ethernet

Certificate File Listing

[Upload Certificate](#)
[List Certificates](#)
[Delete Certificate](#)

TrustedCA.pem 1280 bytes
 1 Files 1280 bytes
 124928 bytes free

.....
 B&B Electronics
 1.815.433.5100 : phone
 1.800.346.3119 : toll free
 1.815.433.5109 : sales fax

B&B Electronics | [Contact Us](#) | [Technical Support](#)
 © 2009-2013 B&B Electronics

Field	CLI Command
Displayed Page	list-cert

Upload Certificate

URL /Certificates/Upload Certificate

Description Enables certificates and private keys to be uploaded to the device.

The screenshot shows the B&B Electronics web interface. At the top left is the B&B Electronics logo with the tagline "Make The Right Connections". A navigation menu includes Status, Configuration, Certificates, Network, and Maintenance. The current page is titled "Upload a Certificate to the Module". On the left side, there are links for "Upload Certificate", "List Certificates", and "Delete Certificate". The main content area prompts the user to "Select a Certificate File to upload and save on the module:" and provides a "Browse..." button. Below this are "Upload Certificate" and "Cancel" buttons. At the bottom of the page, there is a footer with "B&B Electronics | Contact Us | Technical Support" and a copyright notice "© 2009-2013 B&B Electronics".

Field	CLI Command
Upload Certificate [Button]	put-cert

Delete Certificate

URL /Certificates/Delete Certificate

Description Allows certificates stored on the device to be deleted.

The screenshot shows the B&B Electronics web interface. The top navigation bar includes 'Status', 'Configuration', 'Certificates', 'Network', and 'Maintenance'. The 'Certificates' section is selected. The main content area is titled 'Delete a Certificate File From Flash'. Below the title, there is a form with a dropdown menu labeled 'Choose a Certificate File...' and a 'Delete File' button. A sidebar on the left contains links for 'Upload Certificate', 'List Certificates', and 'Delete Certificate'. At the bottom, there is contact information for B&B Electronics and a footer with '© 2009-2013 B&B Electronics'.

Field	CLI Command
Delete Certificate [Button]	del-cert

Network (Home Page)

URL /Network

Description Home page for the network related pages.

B&B ELECTRONICS *Make The Right Connections*

[Status](#)
[Configuration](#)
[Certificates](#)
[Network](#)
[Maintenance](#)
Device Type: Industrial Ethernet

Module Status

[Discover Airborne Modules](#)
[Scan for Access Points](#)

Module Firmware Version: 3.15
 Radio Firmware Version: 3.1.63.21
 Link Status: Connected
 SSID: AP-D23
 MAC Address: 000B28FE0109
 BSSID: 000B28FE0112
 Transmit Rate (Mb/s): 26
 Signal Level (dBm): -25
 Noise Level (dBm): -96
 IP Address: 192.168.10.100
 Subnet Mask: 255.255.255.0
 Default Gateway: 192.168.10.1
 Primary DNS: 10.1.0.5
 Secondary DNS: 10.1.0.39
 Up Time (Sec): 9403

B&B Electronics
 1.815.433.5100: phone
 1.800.346.3119: toll free
 1.815.433.5109: sales fax

[B&B Electronics](#) | [Contact Us](#) | [Technical Support](#)
 © 2009-2013 B&B Electronics

Field	CLI Command
Displayed Page	wl-info

Discover Airborne Modules

URL /Network/Discover Airborne Modules

Description Displays a list of Airborne devices, with IP address, device type and Wireless or Ethernet MAC address, visible to the device on the current network.

B&B ELECTRONICS *Make The Right Connections*

[Status](#)
[Configuration](#)
[Certificates](#)
[Network](#)
[Maintenance](#)
Device Type: Industrial Ethernet

Discover Results

Device Name	IP Address	MAC Address	Device Type	FW Ver
OEM-Crg1	192.168.10.1	000B28FE0112	INDUSTR-SERIAL	3.15
OEM-Crg1	10.1.9.141	000B28FE6121	INDUSTR-SERIAL	3.15

[Discover Airborne Modules](#)
[Scan for Access Points](#)

B&B Electronics
 1.815.433.5100 : phone
 1.800.346.3119 : toll free
 1.815.433.5109 : sales fax

[B&B Electronics](#) | [Contact Us](#) | [Technical Support](#)
 © 2009-2013 B&B Electronics

Field	CLI Command
Displayed Page	discover

Scan for Access Points

URL /Network/Scan for Access Points

Description Displays a list of wireless networks within range of the device

The screenshot shows the B&B Electronics web interface. At the top, there is a navigation menu with options: Status, Configuration, Certificates, Network, and Maintenance. The page title is "Scan Results". On the left side, there is a sidebar with a "Discover Airborne Modules" section containing a link for "Scan for Access Points". The main content area displays the output of a scan for the wlan0 interface. The scan results are as follows:

```

wlan0 Scan completed :
Cell 01 - Address: 7A:1B:28:05:1F:80
        ESSID:""
        Mode:Ad-Hoc
        Frequency:5.18 GHz (Channel 36)
        Quality=19/94 Signal level=-76 dBm Noise level=-95 dBm
        Encryption key:off
        Bit Rates:6 Mb/s; 9 Mb/s; 12 Mb/s; 18 Mb/s; 24 Mb/s
                36 Mb/s; 48 Mb/s; 54 Mb/s
        Protocol:IEEE 802.11a
        Extra:bcn_int=100
Cell 02 - Address: E0:46:9A:BC:3C:B2
        ESSID:"NETGEAR_11a - 0"
        Mode:Master
        Frequency:5.24 GHz (Channel 48)
        Quality=27/94 Signal level=-68 dBm Noise level=-95 dBm
        Encryption key:on
        Bit Rates:6 Mb/s; 9 Mb/s; 12 Mb/s; 18 Mb/s; 24 Mb/s
                36 Mb/s; 48 Mb/s; 54 Mb/s
        IE: IEEE 802.11i/WPA2 Version 1
           Group Cipher : CCMP
           Pairwise Ciphers (1) : CCMP
           Authentication Suites (1) : PSK
        Protocol:IEEE 802.11a
        Extra:bcn_int=100
Cell 03 - Address: E6:46:9A:BC:3C:B2
        ESSID:"NETGEAR_11a - 1"
        Mode:Master
        Frequency:5.24 GHz (Channel 48)
        Quality=27/94 Signal level=-68 dBm Noise level=-95 dBm
        Encryption key:on
        Bit Rates:6 Mb/s; 9 Mb/s; 12 Mb/s; 18 Mb/s; 24 Mb/s
                36 Mb/s; 48 Mb/s; 54 Mb/s
    
```

At the bottom of the interface, there are links for "B&B Electronics", "Contact Us", and "Technical Support", along with a copyright notice: "© 2009-2013 B&B Electronics".

Field	CLI Command
Displayed Page	wl-scan

Maintenance (Home Page)

URL /Maintenance

Description Home page for the maintenance related pages.

B&B ELECTRONICS *Make The Right Connections*

Navigation: Status | Configuration | Certificates | Network | Maintenance | Device Type: Industrial Ethernet

System Information

Firmware Version:	3.15
Radio Firmware Version:	3.1.63.21
Uboot Version:	1.3.2
Kernel Version:	2.6.32.28
Total RAMDisk Space:	224256
RAMDisk Space Used:	94208
Percent RAMDisk Space Used:	42%
RAMDisk Space Free:	130048
FW Partition Total Disk Space:	0
FW Partition Disk Space Used:	0
FW Partition Percent Disk Space Used:	0%
FW Partition Disk Space Free:	0
Total Memory:	30785536
Memory Used:	14639104
Percent Memory Used:	47%
Memory Free:	16146432
Up Time (Sec):	9962

Maintenance Actions:

- [Update Module Firmware](#)
- [Reset to Factory Defaults](#)
- [Restart Module](#)
- [Set System Time](#)
- [Blink the POST LED](#)
- [Stop Blinking the POST LED](#)
- [Upload Script File](#)
- [List Script Files](#)
- [Display Script File](#)
- [Delete Script File](#)
- [Run Script File](#)

Contact Information:

B&B Electronics
 1.816.433.5100 : phone
 1.800.346.3119 : toll free
 1.816.433.5109 : sales fax

Footer: B&B Electronics | Contact Us | Technical Support
 © 2009-2013 B&B Electronics

Field	CLI Command
Displayed Page	sys-info

Update Module Firmware

URL /Maintenance/Update Module Firmware

Description Enables module firmware to be updated.

The screenshot shows the B&B Electronics web interface. At the top, there is a navigation menu with options: Status, Configuration, Certificates, Network, and Maintenance. The device type is identified as 'Industrial Ethernet'. The main content area is titled 'Upload Firmware to the Module' and displays 'Current Firmware Version = 3.15'. Below this, it instructs the user to 'Select the firmware image file to load and then click "Load New Firmware"'. A file selection area includes a 'Browse...' button and a 'Load New Firmware' button. A 'Cancel' button is also present. On the left side, there is a sidebar with various system management links such as 'Update Module Firmware', 'Reset to Factory Defaults', 'Restart Module', 'Set System Time', 'Blink the POST LED', 'Stop Blinking the POST LED', 'Upload Script File', 'List Script Files', 'Display Script File', 'Delete Script File', and 'Run Script File'. At the bottom of the page, there are links for 'B&B Electronics', 'Contact Us', and 'Technical Support', along with a copyright notice for 2009-2013 B&B Electronics.

Field	CLI Command
Load New Firmware [Button]	update

Reset Factory Defaults

URL /Maintenance/Reset Factory Defaults

Description Returns device to factory defaults. If oem_config.txt is present this will take precedence over the factory configuration.

The screenshot shows the B&B Electronics web interface. At the top, the logo and tagline 'Make The Right Connections' are visible. A navigation menu includes 'Status', 'Configuration', 'Certificates', 'Network', and 'Maintenance'. The 'Device Type: Industrial Ethernet' is displayed on the right. The main heading is 'Reset the Module to Factory Defaults'. Below this, a message states: 'Resetting the module to factory defaults removes all user specified configuration settings and resets all passwords to the factory defaults.' A confirmation prompt asks 'Reset the module to factory defaults?' with 'Yes' and 'No' buttons. A sidebar on the left contains links for 'Update Module Firmware', 'Reset to Factory Defaults', 'Restart Module', 'Set System Time', 'Blink the POST LED', 'Stop Blinking the POST LED', 'Upload Script File', 'List Script Files', 'Display Script File', 'Delete Script File', and 'Run Script File'. At the bottom, there is contact information for B&B Electronics and a footer with '© 2009-2013 B&B Electronics'.

Field	CLI Command
Yes [Button]	reset

Restart Module

URL /Maintenance/Restart Module

Description Restarts device.

The screenshot shows the B&B Electronics web interface. At the top left is the B&B Electronics logo with the tagline "Make The Right Connections". A navigation menu includes Status, Configuration, Certificates, Network, and Maintenance. The "Device Type: Industrial Ethernet" is displayed on the right. The main content area is titled "Restart the Module" and contains a warning: "Restarting the module will cause any unsaved changes to be lost." Below this is a confirmation prompt "Restart the module?" with "Yes" and "No" buttons. A sidebar on the left lists various maintenance actions like "Update Module Firmware", "Reset to Factory Defaults", "Restart Module", "Set System Time", "Blink the POST LED", "Stop Blinking the POST LED", "Upload Script File", "List Script Files", "Display Script File", "Delete Script File", and "Run Script File". At the bottom of the sidebar is contact information for B&B Electronics.

Field	CLI Command
Yes [Button]	restart

Set System Time

URL /Maintenance/Set System Time

Description Sets the current system time.

The screenshot shows the B&B Electronics web interface. At the top left is the B&B Electronics logo with the tagline "Make The Right Connections". A navigation menu includes Status, Configuration, Certificates, Network, and Maintenance. The current page is "Set System Time" under the Maintenance section. The page displays the current system time as 13:57:22 EST on Fri Feb 22, 2013. Below this, there is a text prompt: "Enter the desired system time HH:MM:SS MM-DD-YYYY and click 'Set System Time'". A text input field is provided for entering the time. Below the input field are two buttons: "Set System Time" and "Cancel". On the left side of the page, there is a sidebar menu with various system management options such as "Update Module Firmware", "Reset to Factory Defaults", "Restart Module", "Set System Time", "Blink the POST LED", "Stop Blinking the POST LED", "Upload Script File", "List Script Files", "Display Script File", "Delete Script File", and "Run Script File". At the bottom of the page, there is a footer with contact information for B&B Electronics, including phone, toll-free, and sales fax numbers, and a copyright notice for 2009-2013 B&B Electronics.

Field	CLI Command
Set System Time [Button]	sys-time

Blink the POST LED

URL /Maintenance/Blink the POST LED

Description Starts the POST LED blinking. This identifies the specific device being communicated with.

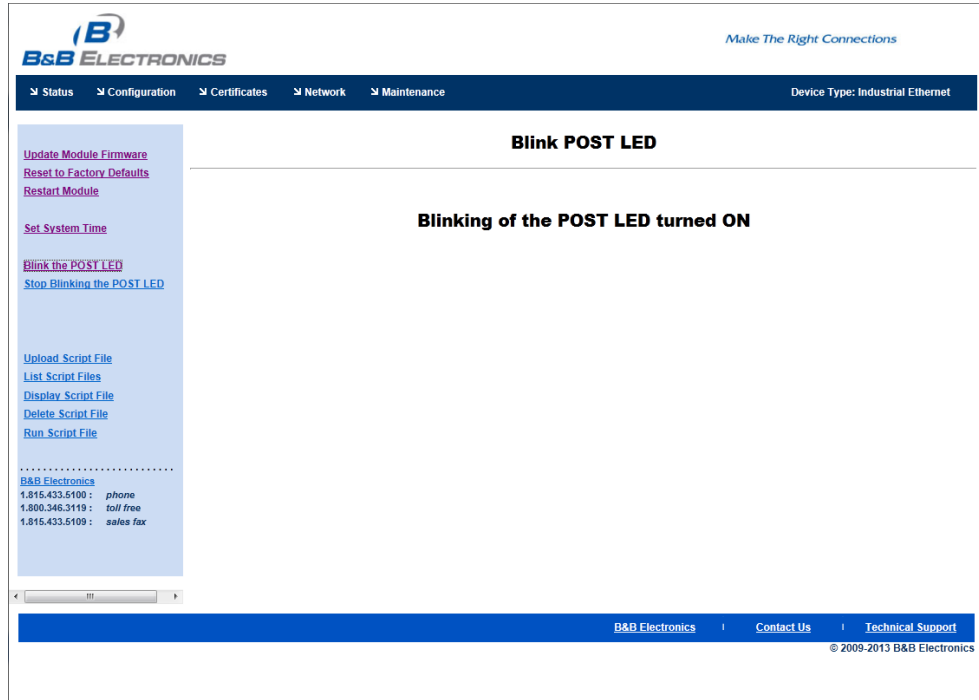

Field	CLI Command
Displayed Page	blink-post-led on

Stop Blinking the POST LED

URL /Maintenance/Stop Blinking the POST LED

Description Stops the POST LED blinking.

The screenshot shows the B&B Electronics web interface. At the top, there is a navigation menu with options: Status, Configuration, Certificates, Network, and Maintenance. The page title is "Blink POST LED". The main content area displays "Blinking of the POST LED turned OFF". A left sidebar contains various system management links: Update Module Firmware, Reset to Factory Defaults, Restart Module, Set System Time, Blink the POST LED, Stop Blinking the POST LED, Upload Script File, List Script Files, Display Script File, Delete Script File, and Run Script File. The footer includes contact information: B&B Electronics, Contact Us, Technical Support, and copyright information: © 2009-2013 B&B Electronics.

Field	CLI Command
Displayed Page	blink-post-led off

25.0 Certification & Regulatory Approvals

The unit complies with the following agency approvals:

Table 48 - Regulatory Approvals

Country	Standard	Status
North America (US & Canada)	FCC Part 15 Sec. 15.107, 15.109, 15.207, 15.209, 15.247 Modular Approval	Complete
Europe	CISPR 16-1 :1993 ETSI EN 300 328 Part 1 V1.2.2 (2000-07) ETSI EN 300 328 Part 2 V1.1.1 (2000-07)	Complete
Japan	ARIB STD-T71 v1.0, 14 (Dec 2000) ARIB RCR STD-T33 (June 19, 1997) ARIB STD-T66 v2.0 (March 28, 2002)	Pending

25.1 FCC Statement

This equipment has been tested and found to comply with the limits for a Class B digital device, pursuant to Part 15 of the FCC Rules. These limits are designed to provide reasonable protection against harmful interference in a residential installation. This equipment generates uses and can radiate radio frequency energy and if not installed and used in accordance with the instructions, may cause harmful interference to radio communications. However, there is no guarantee that interference will not occur in a particular installation. If this equipment does cause harmful interference to radio or television reception, which can be determined by turning the equipment off and on, the user is encouraged to try to correct the interference by one or more of the following measures:

- Reorient or relocate the receiving antenna.
- Increase the separation between the equipment and receiver.
- Connect the equipment to an outlet on a circuit different from that to which the receiver is connected.
- Consult the dealer or an experienced radio/TV technician for assistance.

25.2 FCC RF Exposure Statement

To satisfy RF exposure requirements, this device and its antenna must operate with a separation distance of a least 20 cm from all persons and must not be co-located or operating in conjunction with any other antenna or transmitter.

25.3 Information for Canadian Users (IC Notice)

This device has been designed to operate with an antenna having a maximum gain of 5dBi for 802.11b/g and 802.11a bands. An antenna having a higher gain is strictly prohibited per regulations of Industry Canada. The required antenna impedance is 50 ohms.

To reduce potential radio interference to other users, the antenna type and its gain should be so chosen that the equivalent isotropically radiated power (EIRP) is not more than required for successful communication.

Operation is subject to the following two conditions: (1) this device may not cause interference, and (2) this device must accept any interference, including interference that may cause undesired operation of the device.

25.4 FCC/IC Modular Approval

This document describes the Airborne WLN FCC modular approval and the guidelines for use as outlined in FCC Public Notice (DA-00-1407A1).

The ABDx-XX-DP501 is covered by the following modular grants:

Table 49 - Modular Approval Grant Numbers

Country	Standard	Grant
North America (US)	FCC Part 15 Sec. 15.107, 15.109, 15.207, 15.209, 15.247 Modular Approval	F4AWLNN551
Canada	RSS 210 Modular Approval	3913A-WLNN551

By providing FCC modular approval on the Airborne WLN modules, the customers are relieved of any need to perform FCC part15 subpart C Intentional Radiator testing and certification, except where they wish to use an antenna that is not already certified.

B&B Electronics supports a group of pre-approved antenna; use of one of these antennas eliminates the need to do any further subpart C testing or certification. If an antenna is not on the list, it is a simple process to add it to the pre-approved list without having to complete a full set of emissions testing. Please contact B&B Electronics Technical support for details of our qualification processes.

Please note that as part of the FCC requirements for the use of the modular approval, the installation of any antenna must require a professional installer. This is to prevent any non-authorized antenna being used with the radio. There are ways to support this requirement but the most popular is to utilize a non-standard antenna connector, this designation includes the reverse polarity versions of the most popular RF antenna types (SMA, TNC, etc.). For more details please contact B&B Electronics.

The following documents are associated with this applications note:

- FCC Part 15 – Radio Frequency Devices
- FCC Public Notice – DA-00-1407A1 (June 26th, 2000)

B&B Electronics recommends that during the integration of the radio, into the customers system, that any design guidelines be followed. Please contact B&B Electronics Technical Support if you have any concerns regarding the hardware integration.

Contact B&B Electronics Technical support for a copy of the FCC and IC grant certificates, the test reports and updated approved antenna list.

25.5 Regulatory Test Mode Support

The Airborne Device Server includes support for all FCC, IC and ETSI test modes required to perform regulatory compliance testing on the module, please contact B&B Electronics Technical Support for details on enabling and using these modes.

26.0 Physical & Environmental Approvals

The device has passed the following primary physical and environmental tests. The test methods referenced are defined in SAE J1455 Aug1994.

Table 50 - Mechanical Approvals

Test	Reference	Conditions
Temperature Range (Operational)	Table 1B, Type 2b	-40°C to +85°C
Temperature Range (Non-Operational)		-50°C to +125°C
Humidity	Sect 4.2.3	0-95%RH @ 38°C condensing Fig 4a – 8 hours active humidity cycle
Altitude	Sect 4.8	Operational: 0-12,000ft (62 KPa absolute pressure) Non-operational: 0-40,000ft (18.6 KPa absolute pressure)
Vibration	Sect 4.9	Operational: 2.4 Grms, 10-1K Hz, 1hr per axis Non-operational: 5.2 Grms, 10-1K Hz, 1hr per axis
Shock	Sect 4.10	Operational: 20Gs MAX, 11ms half-sine pulse
Product Drop	Sect 4.10.3.1	1m onto concrete, any face or corner, 1 drop
Packaging Drop	Sect 4.10.2.1	32 inches onto concrete on each face and corner. Packaged in 'for transit' configuration.

Test reports are available from B&B Electronics Technical Support, please contact directly for the latest documentation.