

User Manual

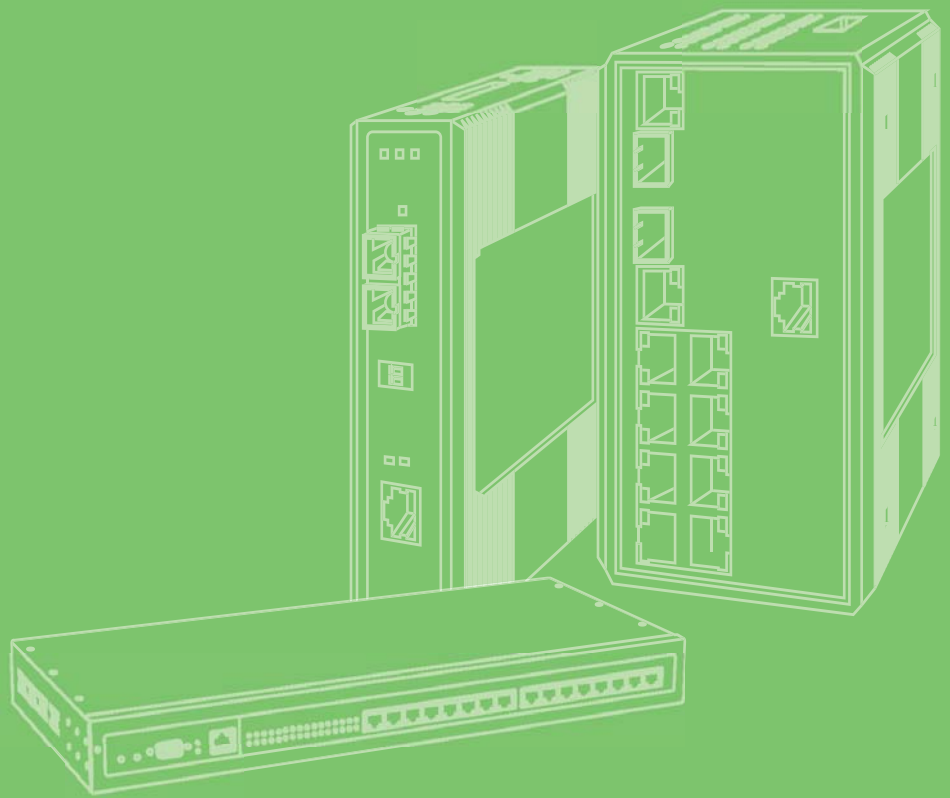

EKI-9510 Series

EN 50155 10-Port M12 Managed/
Unmanaged Non-PoE/PoE
Ethernet Switch

ADVANTECH

Enabling an Intelligent Planet

Copyright

The documentation and the software included with this product are copyrighted 2019 by Advantech Co., Ltd. All rights are reserved. Advantech Co., Ltd. reserves the right to make improvements in the products described in this manual at any time without notice. No part of this manual may be reproduced, copied, translated or transmitted in any form or by any means without the prior written permission of Advantech Co., Ltd. Information provided in this manual is intended to be accurate and reliable. However, Advantech Co., Ltd. assumes no responsibility for its use, nor for any infringements of the rights of third parties, which may result from its use.

Acknowledgements

Intel and Pentium are trademarks of Intel Corporation.

Microsoft Windows and MS-DOS are registered trademarks of Microsoft Corp.

All other product names or trademarks are properties of their respective owners.

Product Warranty (5 years)

Advantech warrants to you, the original purchaser, that each of its products will be free from defects in materials and workmanship for five years from the date of purchase.

This warranty does not apply to any products which have been repaired or altered by persons other than repair personnel authorized by Advantech, or which have been subject to misuse, abuse, accident or improper installation. Advantech assumes no liability under the terms of this warranty as a consequence of such events.

Because of Advantech's high quality-control standards and rigorous testing, most of our customers never need to use our repair service. If an Advantech product is defective, it will be repaired or replaced at no charge during the warranty period. For out-of-warranty repairs, you will be billed according to the cost of replacement materials, service time and freight. Please consult your dealer for more details.

If you think you have a defective product, follow these steps:

1. Collect all the information about the problem encountered. (For example, CPU speed, Advantech products used, other hardware and software used, etc.) Note anything abnormal and list any on screen messages you get when the problem occurs.
2. Call your dealer and describe the problem. Please have your manual, product, and any helpful information readily available.
3. If your product is diagnosed as defective, obtain an RMA (return merchandise authorization) number from your dealer. This allows us to process your return more quickly.
4. Carefully pack the defective product, a fully-completed Repair and Replacement Order Card and a photocopy proof of purchase date (such as your sales receipt) in a shippable container. A product returned without proof of the purchase date is not eligible for warranty service.
5. Write the RMA number visibly on the outside of the package and ship it prepaid to your dealer.

Part No. XXXXXXXXXXXX

Printed in Taiwan

Edition 1

September 2019

Declaration of Conformity

CE

This product has passed the CE test for environmental specifications. Test conditions for passing included the equipment being operated within an industrial enclosure. In order to protect the product from being damaged by ESD (Electrostatic Discharge) and EMI leakage, we strongly recommend the use of CE-compliant industrial enclosure products.

FCC Class A

Note: This equipment has been tested and found to comply with the limits for a Class A digital device, pursuant to part 15 of the FCC Rules. These limits are designed to provide reasonable protection against harmful interference when the equipment is operated in a commercial environment. This equipment generates, uses, and can radiate radio frequency energy and, if not installed and used in accordance with the instruction manual, may cause harmful interference to radio communications. Operation of this equipment in a residential area is likely to cause harmful interference in which case the user will be required to correct the interference at his own expense.

Technical Support and Assistance

1. Visit the Advantech web site at www.advantech.com/support where you can find the latest information about the product.
2. Contact your distributor, sales representative, or Advantech's customer service center for technical support if you need additional assistance. Please have the following information ready before you call:
 - Product name and serial number
 - Description of your peripheral attachments
 - Description of your software (operating system, version, application software, etc.)
 - A complete description of the problem
 - The exact wording of any error messages

Warnings, Cautions and Notes

Warning! Warnings indicate conditions, which if not observed, can cause personal injury!



Caution! Cautions are included to help you avoid damaging hardware or losing data. e.g.



There is a danger of a new battery exploding if it is incorrectly installed. Do not attempt to recharge, force open, or heat the battery. Replace the battery only with the same or equivalent type recommended by the manufacturer. Discard used batteries according to the manufacturer's instructions.

Note! Notes provide optional additional information.



Document Feedback

To assist us in making improvements to this manual, we would welcome comments and constructive criticism. Please send all such - in writing to: support@advantech.com

Packing List

Before setting up the system, check that the items listed below are included and in good condition. If any item does not accord with the table, please contact your dealer immediately.

- 1 x EN 50155 10-Port M12 Managed/Unmanaged Non-PoE/PoE Ethernet Switch

Safety Instructions

- Read these safety instructions carefully.
- Keep this User Manual for later reference.
- Disconnect this equipment from any DC outlet before cleaning. Use a damp cloth. Do not use liquid or spray detergents for cleaning.
- For plug-in equipment, the power outlet socket must be located near the equipment and must be easily accessible.
- Keep this equipment away from humidity.
- Put this equipment on a reliable surface during installation. Dropping it or letting it fall may cause damage.
- The openings on the enclosure are for air convection. Protect the equipment from overheating. **DO NOT COVER THE OPENINGS.**
- Make sure the voltage of the power source is correct before connecting the equipment to the power outlet.
- Position the power cord so that people cannot step on it. Do not place anything over the power cord.
- All cautions and warnings on the equipment should be noted.
- If the equipment is not used for a long time, disconnect it from the power source to avoid damage by transient overvoltage.
- Never pour any liquid into an opening. This may cause fire or electrical shock.
- Never open the equipment. For safety reasons, the equipment should be opened only by qualified service personnel.
- If one of the following situations arises, get the equipment checked by service personnel:
 - The power cord or plug is damaged.
 - Liquid has penetrated into the equipment.
 - The equipment has been exposed to moisture.
 - The equipment does not work well, or you cannot get it to work according to the user's manual.
 - The equipment has been dropped and damaged.
 - The equipment has obvious signs of breakage.
- **DO NOT LEAVE THIS EQUIPMENT IN AN ENVIRONMENT WHERE THE STORAGE TEMPERATURE MAY GO -40°C (-40°F) ~ 85°C (185°F). THIS COULD DAMAGE THE EQUIPMENT. THE EQUIPMENT SHOULD BE IN A CONTROLLED ENVIRONMENT.**
- For equipment intended for installation in a **RESTRICTED ACCESS LOCATION**, the temperature limits in 70°C.
- The sound pressure level at the operator's position according to IEC 704-1:1982 is no more than 70 dB (A).

DISCLAIMER: This set of instructions is given according to IEC 704-1. Advantech disclaims all responsibility for the accuracy of any statements contained herein.

Wichtige Sicherheitshinweise

- Bitte lesen sie Sich diese Hinweise sorgfältig durch.
- Heben Sie diese Anleitung für den späteren Gebrauch auf.
- Vor jedem Reinigen ist das Gerät vom Stromnetz zu trennen. Verwenden Sie Keine Flüssig-oder Aerosolreiniger. Am besten dient ein angefeuchtetes Tuch zur Reinigung.
- Die Netzanschlussteckdose soll nahe dem Gerät angebracht und leicht zugänglich sein.
- Das Gerät ist vor Feuchtigkeit zu schützen.
- Bei der Aufstellung des Gerätes ist auf sicheren Stand zu achten. Ein Kippen oder Fallen könnte Verletzungen hervorrufen.
- Die Belüftungsöffnungen dienen zur Luftzirkulation die das Gerät vor überhitzung schützt. Sorgen Sie dafür, daß diese Öffnungen nicht abgedeckt werden.
- Beachten Sie beim. Anschluß an das Stromnetz die Anschlußwerte.
- Verlegen Sie die Netzanschlusbleitung so, daß niemand darüber fallen kann. Es sollte auch nichts auf der Leitung abgestellt werden.
- Alle Hinweise und Warnungen die sich am Geräten befinden sind zu beachten.
- Wird das Gerät über einen längeren Zeitraum nicht benutzt, sollten Sie es vom Stromnetz trennen. Somit wird im Falle einer Überspannung eine Beschädigung vermieden.
- Durch die Lüftungsöffnungen dürfen niemals Gegenstände oder Flüssigkeiten in das Gerät gelangen. Dies könnte einen Brand bzw. elektrischen Schlag auslösen.
- Öffnen Sie niemals das Gerät. Das Gerät darf aus Gründen der elektrischen Sicherheit nur von autorisiertem Servicepersonal geöffnet werden.
- Wenn folgende Situationen auftreten ist das Gerät vom Stromnetz zu trennen und von einer qualifizierten Servicestelle zu überprüfen:
 - Netzkabel oder Netzstecker sind beschädigt.
 - Flüssigkeit ist in das Gerät eingedrungen.
 - Das Gerät war Feuchtigkeit ausgesetzt.
 - Wenn das Gerät nicht der Bedienungsanleitung entsprechend funktioniert oder Sie mit Hilfe dieser Anleitung keine Verbesserung erzielen.
 - Das Gerät ist gefallen und/oder das Gehäuse ist beschädigt.
 - Wenn das Gerät deutliche Anzeichen eines Defektes aufweist.
- Der arbeitsplatzbezogene Schalldruckpegel nach DIN 45 635 Teil 1000 beträgt 70dB(A) oder weiger.

Haftungsausschluss: Die Bedienungsanleitungen wurden entsprechend der IEC-704-1 erstellt. Advantech lehnt jegliche Verantwortung für die Richtigkeit der in diesem Zusammenhang getätigten Aussagen ab.

Safety Precaution - Static Electricity

Static electricity can cause bodily harm or damage electronic devices. To avoid damage, keep static-sensitive devices in the static-protective packaging until the installation period. The following guidelines are also recommended:

- Wear a grounded wrist or ankle strap and use gloves to prevent direct contact to the device before servicing the device. Avoid nylon gloves or work clothes, which tend to build up a charge.
- Always disconnect the power from the device before servicing it.
- Before plugging a cable into any port, discharge the voltage stored on the cable by touching the electrical contacts to the ground surface.

Contents

Chapter 1	Product Overview	1
1.1	Specifications.....	2
1.2	Hardware Views.....	5
1.2.1	Front View.....	5
1.3	Dimensions	10
Chapter 2	Switch Installation	14
2.1	Installation Guidelines.....	15
2.1.1	Connecting Hardware	15
2.2	Verifying Switch Operation.....	15
2.3	Installing the Switch	16
2.3.1	Wall-Mounting.....	16
2.4	Power Supply Installation.....	17
2.4.1	Overview.....	17
2.4.2	Considerations.....	18
2.4.3	Grounding the Device	18
2.4.4	Wiring the Power Inputs.....	19
2.5	Connecting the Ethernet Media	21
2.5.1	Connecting the 10/100Mbps Ports	21
2.5.2	Connecting the 10/100/1000Mbps Ports	21
2.6	Connecting the Console Terminal.....	22
2.6.1	M12 A-Coded Connector Pin Assignment.....	22
Chapter 3	Configuration Utility	23
3.1	First Time Setup.....	24
3.1.1	Overview.....	24
3.1.2	Introduction	24
3.1.3	Administrative Interface Access.....	24
3.1.4	Using the Graphical (Web) Interface	25
3.1.5	Configuring the Switch for Network Access.....	25
3.1.6	Configuring the Ethernet Ports	26
3.2	Command Line Interface Configuration	27
3.2.1	Introduction to Command-Line Interface (CLI)	27
3.2.2	Accessing the CLI.....	27
3.3	Web Browser Configuration	28
3.3.1	Preparing for Web Configuration	28
3.3.2	System Login	28
Chapter 4	Managing Switch.....	29
4.1	Log In	30
4.2	Recommended Practices.....	30
4.2.1	Changing Default Password	30
4.3	Monitoring	31
4.3.1	Device Information.....	31
4.3.2	Logging Message	32
4.3.3	Port Monitoring	33
4.3.4	Link Aggregation.....	34
4.3.5	LLDP Statistics	35

	4.3.6	IGMP Statistics	36
	4.3.7	MLD Statistics	37
4.4		System	38
	4.4.1	IP Settings.....	38
	4.4.2	IPv6 Settings.....	39
	4.4.3	DHCP Client Option 82.....	40
	4.4.4	DHCP Auto Provision.....	41
	4.4.5	Management VLAN.....	41
	4.4.6	System Time	42
	4.4.7	Network Port	43
4.5		L2 Switching.....	44
	4.5.1	Port Configuration	44
	4.5.2	Port Mirror	45
	4.5.3	Link Aggregation	46
	4.5.4	802.1Q VLAN.....	49
	4.5.5	Q-in-Q	52
	4.5.6	GARP	54
	4.5.7	802.3az EEE	56
	4.5.8	Multicast.....	56
	4.5.9	Jumbo Frame.....	61
	4.5.10	Spanning Tree	62
	4.5.11	X-Ring Elite	67
	4.5.12	X-Ring Pro	68
	4.5.13	Loopback Detection	71
	4.5.14	ERPS	72
4.6		MAC Address Table	74
	4.6.1	Static MAC	74
	4.6.2	MAC Aging Time.....	74
	4.6.3	Dynamic Forwarding Table	75
4.7		Security	76
	4.7.1	Storm Control.....	76
	4.7.2	Port Security	78
	4.7.3	Protected Ports	78
	4.7.4	DoS Prevention.....	79
	4.7.5	Applications.....	81
	4.7.6	802.1x	84
	4.7.7	IP Security.....	85
	4.7.8	Security Login	86
	4.7.9	Access Control List	89
	4.7.10	IP Source Guard	91
	4.7.11	DHCP Snooping.....	92
	4.7.12	ARP Spoofing	93
4.8		QoS.....	94
	4.8.1	General	94
	4.8.2	QoS Basic Mode	100
	4.8.3	Rate Limit.....	101
	4.8.4	Bandwidth Guarantee	103
4.9		Management	105
	4.9.1	LLDP	105
	4.9.2	SNMP.....	108
	4.9.3	Power Over Ethernet	111
	4.9.4	TCP Modbus Settings.....	113
	4.9.5	DHCP Server	114
	4.9.6	SMTP Client.....	120
	4.9.7	RMON.....	122
	4.9.8	NTP Server	126
4.10		Diagnostics.....	127
	4.10.1	Cable Diagnostics	127
	4.10.2	Ping Test.....	128
	4.10.3	IPv6 Ping Test.....	129

	4.10.4	System Log.....	131
	4.10.5	LED Indication	133
4.11		Tools	134
	4.11.1	IXM	134
	4.11.2	Backup Manager.....	135
	4.11.3	Upgrade Manager.....	136
	4.11.4	Dual Image	137
	4.11.5	Save Configuration	137
	4.11.6	User Account	137
	4.11.7	N-Key.....	138
	4.11.8	Reset System	138
	4.11.9	Reboot Device	138
4.12		Modbus/TCP Mapping	139
	4.12.1	Modbus/TCP Mapping Table.....	139

List of Figures

Figure 1.1	Front View	5
Figure 1.2	Front View	5
Figure 1.3	Front View	6
Figure 1.4	Front View	6
Figure 1.5	Front View	7
Figure 1.6	Front View	7
Figure 1.7	Front View	8
Figure 1.8	Front View	8
Figure 1.9	System LED Panel	9
Figure 1.10	EKI-9510E-2GH/EKI-9510E-2GL Dimensions	10
Figure 1.11	EKI-9510E-2GMH/EKI-9510E-2GML Dimensions	10
Figure 1.12	EKI-9510E-2GMPH/EKI-9510E-2GMPL Dimensions.....	11
Figure 1.13	EKI-9510E-2GPH/EKI-9510E-2GPL Dimensions.....	11
Figure 1.14	EKI-9510G-2GH/EKI-9510G-2GL Dimensions.....	12
Figure 1.15	EKI-9510G-2GMH/EKI-9510G-2GML Dimensions.....	12
Figure 1.16	EKI-9510G-2GMPH/EKI-9510G-2GMPL Dimensions.....	13
Figure 1.17	EKI-9510G-2GPH/EKI-9510G-2GPL Dimensions	13
Figure 2.1	Securing Wall Mounting Screws.....	16
Figure 2.2	Switch Installation.....	16
Figure 2.3	Power Wiring for EKI-9510 Series.....	17
Figure 2.4	Grounding Connection, Chassis Left Side View.....	19
Figure 2.5	Installing the Power Cable.....	20
Figure 2.6	Standard M12 4-Pin Female DC Power Input Connector.....	20
Figure 2.7	M12 D-Coded Connector Pin Assignment.....	21
Figure 2.8	M12 X-Coded Connector Pin Assignment.....	21
Figure 2.9	M12 A-Coded Connector Pin Assignment.....	22
Figure 4.1	Login Screen	30
Figure 4.2	Changing a Default Password	31
Figure 4.3	Monitoring > Device Information.....	31
Figure 4.4	Monitoring > Logging Message	32
Figure 4.5	Monitoring > Port Monitoring > Port Statistics	33
Figure 4.6	Monitoring > Port Monitoring > Port Utilization	34
Figure 4.7	Monitoring > LLDP Statistics	35
Figure 4.8	Monitoring > IGMP Statistics	36
Figure 4.9	Monitoring > MLD Statistics.....	37
Figure 4.10	System > IP Settings	38
Figure 4.11	System > IPv6 Settings	39
Figure 4.12	System > DHCP Client Option 82.....	40
Figure 4.13	System > DHCP Auto Provision	41
Figure 4.14	System > Management VLAN	41
Figure 4.15	System > System Time.....	42
Figure 4.16	System > Network Port.....	43
Figure 4.17	L2 Switching > Port Configuration	44
Figure 4.18	L2 Switching > Port Mirror	45
Figure 4.19	L2 Switching > Link Aggregation > Load Balance	46
Figure 4.20	L2 Switching > Link Aggregation > LAG Management.....	46
Figure 4.21	L2 Switching > Link Aggregation > LAG Port Settings	47
Figure 4.22	L2 Switching > Link Aggregation > LACP Priority Settings	47
Figure 4.23	L2 Switching > Link Aggregation > LACP Port Settings	48
Figure 4.24	L2 Switching > 802.1Q VLAN > VLAN Management	49
Figure 4.25	L2 Switching > 802.1Q VLAN > PVID Settings	50
Figure 4.26	L2 Switching > 802.1Q VLAN > Port to VLAN.....	51
Figure 4.27	L2 Switching > Q-in-Q > Global Settings.....	52
Figure 4.28	L2 Switching > Q-in-Q > Port Settings.....	53
Figure 4.29	L2 Switching > GARP > GARP Settings.....	54
Figure 4.30	L2 Switching > GARP > GVRP Settings.....	55

Figure 4.31	L2 Switching > GARP > GMRP Settings.....	55
Figure 4.32	L2 Switching > 802.3az EEE.....	56
Figure 4.33	L2 Switching > Multicast > Multicast Filtering.....	56
Figure 4.34	L2 Switching > Multicast > IGMP Snooping > IGMP Settings.....	57
Figure 4.35	L2 Switching > Multicast > IGMP Snooping > IGMP Querier.....	58
Figure 4.36	L2 Switching > Multicast > IGMP Snooping > IGMP Static Groups.....	58
Figure 4.37	L2 Switching > Multicast > MLD Snooping > MLD Settings.....	59
Figure 4.38	L2 Switching > Multicast > MLD Snooping > MLD Querier.....	60
Figure 4.39	L2 Switching > Multicast > MLD Snooping > MLD Static Group.....	60
Figure 4.40	L2 Switching > Jumbo Frame.....	61
Figure 4.41	L2 Switching > Spanning Tree > STP Global Settings.....	62
Figure 4.42	L2 Switching > Spanning Tree > STP Port Settings.....	63
Figure 4.43	L2 Switching > Spanning Tree > STP Bridge Settings.....	64
Figure 4.44	L2 Switching > Spanning Tree > STP Port Advanced Settings.....	65
Figure 4.45	L2 Switching > Spanning Tree > MST Config Identification.....	65
Figure 4.46	L2 Switching > Spanning Tree > MST Instance ID Settings.....	66
Figure 4.47	L2 Switching > Spanning Tree > MST Instance Priority Settings.....	66
Figure 4.48	L2 Switching > X-Ring Elite > X-Ring Elite Settings.....	67
Figure 4.49	L2 Switching > X-Ring Elite > X-Ring Elite Groups.....	68
Figure 4.50	L2 Switching > X-Ring Pro > X-Ring Pro Settings.....	68
Figure 4.51	L2 Switching > X-Ring Pro > X-Ring Pro Groups > X-Ring Pro Groups Settings.....	69
Figure 4.52	L2 Switching > X-Ring Pro > X-Ring Pro Groups > Chain Settings.....	69
Figure 4.53	L2 Switching > X-Ring Pro > X-Ring Pro Groups > Couple Setting.....	69
Figure 4.54	L2 Switching > X-Ring Pro > X-Ring Pro Groups > Pair Settings.....	70
Figure 4.55	L2 Switching > X-Ring Pro > X-Ring Pro Groups > RPair Settings.....	70
Figure 4.56	L2 Switching > Loopback Detection > Global Settings.....	71
Figure 4.57	L2 Switching > Loopback Detection > Port Settings.....	72
Figure 4.58	L2 Switching > ERPS > ERPS Settings.....	72
Figure 4.59	L2 Switching > ERPS > ERPS Groups.....	73
Figure 4.60	MAC Address Table > Static MAC.....	74
Figure 4.61	MAC Address Table > MAC Aging Time.....	74
Figure 4.62	MAC Address Table > Dynamic Forwarding Table.....	75
Figure 4.63	Security > Storm Control > Global Settings.....	76
Figure 4.64	Security > Storm Control > Port Settings.....	77
Figure 4.65	Security > Port Security.....	78
Figure 4.66	Security > Protected Ports.....	78
Figure 4.67	Security > DoS Prevention > DoS Global Settings.....	79
Figure 4.68	Security > DoS Prevention > DoS Port Settings.....	81
Figure 4.69	Security > Applications > TELNET.....	81
Figure 4.70	Security > Applications > SSH.....	82
Figure 4.71	Security > Applications > HTTP.....	82
Figure 4.72	Security > Applications > HTTPS.....	83
Figure 4.73	Security > 802.1x > 802.1x Global Settings.....	84
Figure 4.74	Security > 802.1x > 802.1x Port Configuration.....	85
Figure 4.75	Security > IP Security > Global Settings.....	85
Figure 4.76	Security > IP Security > Entry Settings.....	86
Figure 4.77	Security > Security Login > Global Settings > Global Settings.....	86
Figure 4.78	Security > Security Login > Global Settings > RADIUS Settings.....	87
Figure 4.79	Security > Security Login > Global Settings > TACACS Settings.....	87
Figure 4.80	Security > Security Login > Access Control Settings > Security Login Type Settings.....	88
Figure 4.81	Security > Security Login > Access Control Settings > Security Login Type Settings.....	88
Figure 4.82	Security > Access Control List > MAC ACL > Entry Settings.....	89
Figure 4.83	Security > Access Control List > IP ACL > Entry Settings.....	90
Figure 4.84	Security > IP Source Guard > Global Settings.....	91
Figure 4.85	Security > IP Source Guard > Entry Settings.....	91
Figure 4.86	Security > DHCP Snooping > Global Settings > DHCP Snooping State Settings.....	92
Figure 4.87	Security > DHCP Snooping > Global Settings > DHCP Snooping Port Settings.....	92

Figure 4.88	Security > DHCP Snooping > Global Settings > DHCP Snooping Binding Port Settings	93
Figure 4.89	Security > ARP Spoofing	93
Figure 4.90	QoS > General > QoS Properties	94
Figure 4.91	QoS > General > QoS Settings	95
Figure 4.92	QoS > General > QoS Scheduling	96
Figure 4.93	QoS > General > CoS Mapping	97
Figure 4.94	QoS > General > DSCP Mapping	98
Figure 4.95	QoS > General > IP Precedence Mapping	99
Figure 4.96	QoS > QoS Basic Mode > Global Settings	100
Figure 4.97	QoS > QoS Basic Mode > Port Settings	100
Figure 4.98	QoS > Rate Limit > Ingress Bandwidth Control	101
Figure 4.99	QoS > Rate Limit > Egress Bandwidth Control	101
Figure 4.100	QoS > Rate Limit > Egress Queue	102
Figure 4.101	QoS > Bandwidth Guarantee > Global Settings	103
Figure 4.102	QoS > Bandwidth Guarantee > Utilization	104
Figure 4.103	Management > LLDP > LLDP System Settings	105
Figure 4.104	Management > LLDP > LLDP Port Settings > LLDP Port Configuration	106
Figure 4.105	Management > LLDP > LLDP Port Settings > Optional TLVs Selection	106
Figure 4.106	Management > LLDP > LLDP Port Settings > VLAN Name TLV VLAN Selection	107
Figure 4.107	Management > LLDP > LLDP Remote Device Info	107
Figure 4.108	Management > SNMP > SNMP Settings	108
Figure 4.109	Management > SNMP > SNMP Community	108
Figure 4.110	Management > SNMP > SNMPv3 EngineID	109
Figure 4.111	Management > SNMP > SNMPv3 Settings	109
Figure 4.112	Management > SNMP > SNMP Trap	110
Figure 4.113	Management > Power Over Ethernet > PoE System Settings	111
Figure 4.114	Management > Power Over Ethernet > PoE Port Settings	112
Figure 4.115	Management > TCP Modbus Settings > TCP Modbus Settings	113
Figure 4.116	Management > DHCP Server > Status Settings	114
Figure 4.117	Management > DHCP Server > Global Settings	115
Figure 4.118	Management > DHCP Server > Port Settings	116
Figure 4.119	Management > DHCP Server > VLAN Settings	117
Figure 4.120	Management > DHCP Server > Option 82 Settings	118
Figure 4.121	Management > DHCP Server > Client MAC Settings	119
Figure 4.122	Management > SMTP Client > Global Settings	120
Figure 4.123	Management > SMTP Client > Profile Settings > Profile Settings	120
Figure 4.124	Management > SMTP Client > Profile Settings > Profile Target Mail Settings	121
Figure 4.125	Management > SMTP Client > Sending Message	121
Figure 4.126	Management > RMON > Rmon Statistics	122
Figure 4.127	Management > RMON > RMON History	123
Figure 4.128	Management > RMON > Rmon Alarm	124
Figure 4.129	Management > RMON > RMON Event	125
Figure 4.130	Management > NTP Server	126
Figure 4.131	Diagnostics > Cable Diagnostics	127
Figure 4.132	Diagnostics > Ping Test	128
Figure 4.133	Diagnostics > IPv6 Ping Test	129
Figure 4.134	Diagnostics > System Log > Logging Service	131
Figure 4.135	Diagnostics > System Log > Local Logging	131
Figure 4.136	Diagnostics > System Log > System Log Server	132
Figure 4.137	Diagnostics > LED Indication	133
Figure 4.138	Tools > IXM	134
Figure 4.139	Tools > Backup Manager	135
Figure 4.140	Tools > Upgrade Manager	136
Figure 4.141	Tools > Dual Image	137
Figure 4.142	Tools > User Account	137
Figure 4.143	Tools > N-Key	138

Chapter 1

Product Overview

1.1 Specifications

Specifications	Description			
Interface	I/O Port	<ul style="list-style-type: none"> ■ EKI-9510E-2GH/EKI-9510E-2GL: 8 x 10/100Mbps M12 D-Coded + 2 x 10/100/1000Mbps M12 X-Coded with Bypass function ■ EKI-9510E-2GMH/EKI-9510E-2GML: 8 x 10/100Mbps M12 D-Coded + 2 x 10/100/1000Mbps M12 X-Coded with Bypass function ■ EKI-9510E-2GMPH/EKI-9510E-2GMPL: 8 x 10/100Mbps M12 D-Coded PoE ports + 2 x 10/100/1000Mbps M12 X-Coded with Bypass function ■ EKI-9510E-2GPH/EKI-9510E-2GPL: 8 x 10/100Mbps M12 D-Coded PoE ports + 2 x 10/100/1000Mbps M12 X-Coded with Bypass function ■ EKI-9510G-2GH/EKI-9510G-2GL: 8 x 10/100/1000Mbps M12 X-Coded + 2 x 10/100/1000Mbps M12 X-Coded ports with Bypass function ■ EKI-9510G-2GMH/EKI-9510G-2GML: 8 x 10/100/1000Mbps M12 X-Coded + 2 x 10/100/1000Mbps M12 X-Coded ports with Bypass function ■ EKI-9510G-2GMPH/EKI-9510G-2GMPL: 8 x 10/100/1000Mbps M12 X-Coded PoE ports + 2 x 10/100/1000Mbps M12 X-Coded ports with Bypass function ■ EKI-9510G-2GPH/EKI-9510G-2GPL: 8 x 10/100/1000Mbps M12 X-Coded + 2 x 10/100/1000Mbps M12 X-Coded ports with Bypass function 		
		Console Port	M12 A-Coded (only for EKI-9510E-2GMH/EKI-9510E-2GML, EKI-9510E-2GMPH/EKI-9510E-2GMPL, EKI-9510G-2GMH/EKI-9510G-2GML and EKI-9510G-2GMPH/EKI-9510G-2GMPL)	
		Power Connector	M12 A-Coded	
		Physical	Enclosure	Aluminum Shell
			Protection Class	IP40
			Installation	Wall mount
			Dimensions (W x H x D)	216 x 132 x 59.3 mm (8.5" x 5.2" x 2.33")
Weight	1.5 kg (3.31 lbs)			
LED Display	System LED	SYS, PWR1, PWR2, Alarm, R.M. (R.M. is only for EKI-9510E-2GMH/EKI-9510E-2GML, EKI-9510E-2GMPH/EKI-9510E-2GMPL, EKI-9510G-2GMH/EKI-9510G-2GML and EKI-9510G-2GMPH/EKI-9510G-2GMPL)		
	Port LED	Data, PoE (only for EKI-9510E-2GMPH/EKI-9510E-2GMPL, EKI-9510E-2GPH/EKI-9510E-2GPL, EKI-9510G-2GMPH/EKI-9510G-2GMPL and EKI-9510G-2GPH/EKI-9510G-2GPL)		

Specifications	Description	
Environment	Operating Temperature	-40°C ~ 70°C (-40°F ~ 158°F)
	Storage Temperature	-40°C ~ 85°C (-40°F ~ 185°F)
	Ambient Relative Humidity	5 ~ 95% (non-condensing)
Switch Properties	MAC Address	8K
	Jumbo Frame	9 KB
Power	Power Consumption	10 Watts
	PoE Power Budget	<ul style="list-style-type: none"> ■ EKI-9510E-2GMPL: 120 Watts ■ EKI-9510E-2GMPL: 60 Watts ■ EKI-9510E-2GPH: 120 Watts ■ EKI-9510E-2GPL: 60 Watts ■ EKI-9510G-2GMPL: 120 Watts ■ EKI-9510G-2GMPL: 60 Watts ■ EKI-9510G-2GPH: 120 Watts ■ EKI-9510G-2GPL: 60 Watts
	Power Input	<ul style="list-style-type: none"> ■ EKI-9510E-2GH: 72/96/110 V_{DC} ■ EKI-9510E-2GL: 24/48 V_{DC} ■ EKI-9510E-2GMH: 72/96/110 V_{DC} ■ EKI-9510E-2GML: 24/48 V_{DC} ■ EKI-9510E-2GMPL: 72/96/110 V_{DC} ■ EKI-9510E-2GMPL: 24/48 V_{DC} ■ EKI-9510E-2GPH: 72/96/110 V_{DC} ■ EKI-9510E-2GPL: 24/48 V_{DC} ■ EKI-9510G-2GH: 72/96/110 V_{DC} ■ EKI-9510G-2GL: 24/48 V_{DC} ■ EKI-9510G-2GMH: 72/96/110 V_{DC} ■ EKI-9510G-2GML: 24/48 V_{DC} ■ EKI-9510G-2GMPL: 72/96/110 V_{DC} ■ EKI-9510G-2GMPL: 24/48 V_{DC} ■ EKI-9510G-2GPH: 72/96/110 V_{DC} ■ EKI-9510G-2GPL: 24/48 V_{DC}

Specifications	Description
Power	Operating Voltage ■ EKI-9510E-2GH: 50.4 ~ 137.5 V _{DC} ■ EKI-9510E-2GL: 16.8 ~ 60 V _{DC} ■ EKI-9510E-2GMH: 50.4 ~ 137.5 V _{DC} ■ EKI-9510E-2GML: 16.8 ~ 60 V _{DC} ■ EKI-9510E-2GMPH: 50.4 ~ 137.5 V _{DC} ■ EKI-9510E-2GMPL: 16.8 ~ 60 V _{DC} ■ EKI-9510E-2GPH: 50.4 ~ 137.5 V _{DC} ■ EKI-9510E-2GPL: 16.8 ~ 60 V _{DC} ■ EKI-9510G-2GH: 50.4 ~ 137.5 V _{DC} ■ EKI-9510G-2GL: 16.8 ~ 60 V _{DC} ■ EKI-9510G-2GMH: 50.4 ~ 137.5 V _{DC} ■ EKI-9510G-2GML: 16.8 ~ 60 V _{DC} ■ EKI-9510G-2GMPH: 50.4 ~ 137.5 V _{DC} ■ EKI-9510G-2GMPL: 16.8 ~ 60 V _{DC} ■ EKI-9510G-2GPH: 50.4 ~ 137.5 V _{DC} ■ EKI-9510G-2GPL: 16.8 ~ 60 V _{DC} Dual inputs supports overload current protection and reverse polarity protection
Certifications	EMI ■ FCC Part 15 Subpart B Class A ■ CE EN55022 (CISPR) ■ EN55024 Class A EMS ■ EN61000-4-2 (ESD) ■ EN61000-4-3 (RS) ■ EN61000-4-4 (EFT) ■ EN61000-4-5 (Surge) ■ EN61000-4-6 (CS) Shock IEC 61373 Freefall IEC 60068-2-32 Vibration IEC 61373 Rail Traffic ■ EN50155 ■ EN50121-3-2

1.2 Hardware Views

1.2.1 Front View

1.2.1.1 EKI-9510E-2GH/EKI-9510E-2GL

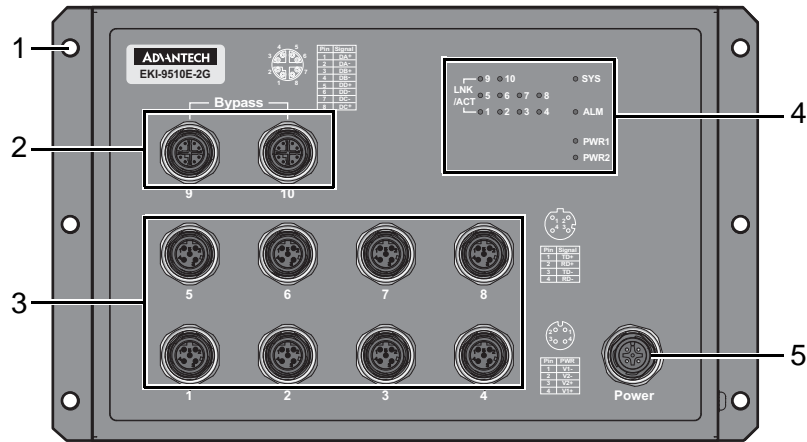

Figure 1.1 Front View

No.	Item	Description
1	Wall mounting holes	Screw holes (x6) used in the installation on wall.
2	ETH port	10/100/1000Base-T M12 x 2 (X-coding)
3	ETH port	10/100Base-T M12 x 8 (D-coding)
4	System LED panel	See “System LED Panel” on page 9 for further details.
5	Power input port	M12 5-pin (male) DC power connector port.

1.2.1.2 EKI-9510E-2GMH/EKI-9510E-2GML

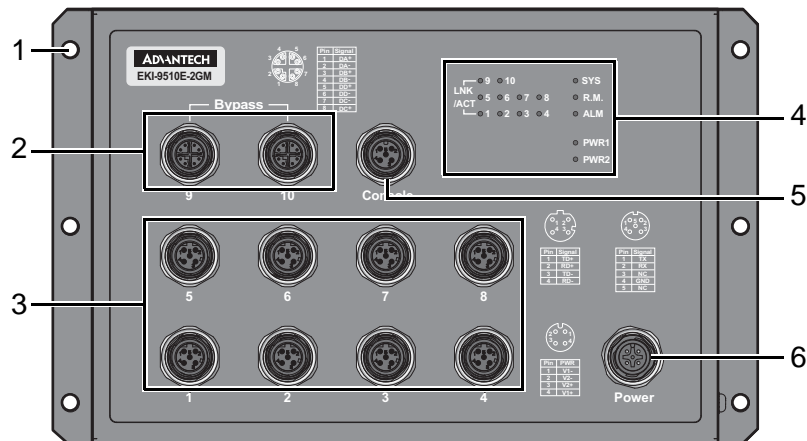

Figure 1.2 Front View

No.	Item	Description
1	Wall mounting holes	Screw holes (x6) used in the installation on wall.
2	ETH port	10/100/1000Base-T M12 x 2 (X-coding)
3	ETH port	10/100Base-T M12 x 8 (D-coding)
4	System LED panel	See “System LED Panel” on page 9 for further details.
5	Console port	M12 5-pin (female) port to access the managed switch's software.
6	Power input port	M12 5-pin (male) DC power connector port.

1.2.1.3 EKI-9510E-2GMPH/EKI-9510E-2GMPL

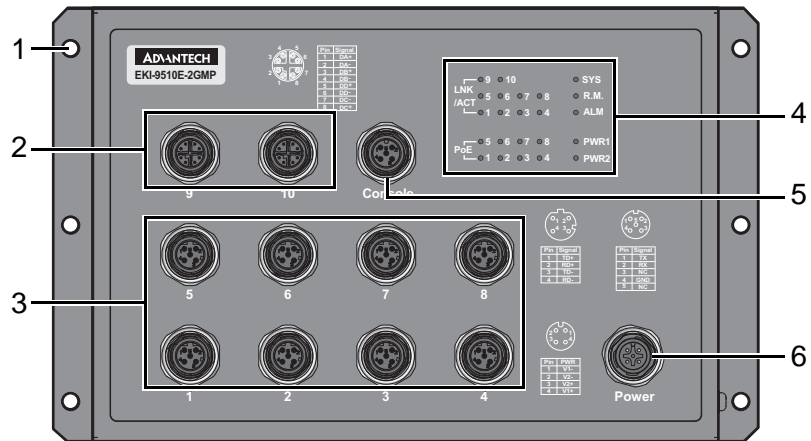

Figure 1.3 Front View

No.	Item	Description
1	Wall mounting holes	Screw holes (x6) used in the installation on wall.
2	ETH port	10/100/1000Base-T M12 x 2 (X-coding)
3	ETH port	10/100Base-T M12 x 8 (D-coding)
4	System LED panel	See "System LED Panel" on page 9 for further details.
5	Console port	M12 5-pin (female) port to access the managed switch's software.
6	Power input port	M12 5-pin (male) DC power connector port.

1.2.1.4 EKI-9510E-2GPH/EKI-9510E-2GPL

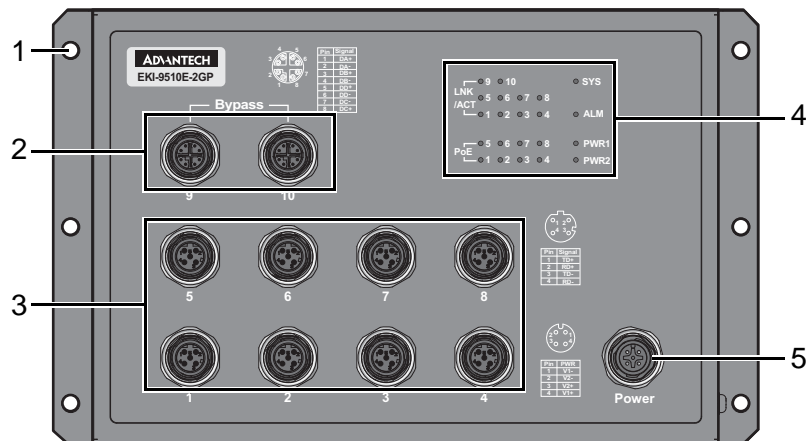

Figure 1.4 Front View

No.	Item	Description
1	Wall mounting holes	Screw holes (x6) used in the installation on wall.
2	ETH port	10/100/1000Base-T M12 x 2 (X-coding)
3	ETH port	10/100Base-T M12 x 8 (D-coding)
4	System LED panel	See "System LED Panel" on page 9 for further details.
5	Power input port	M12 5-pin (male) DC power connector port.

1.2.1.5 EKI-9510G-2GH/EKI-9510G-2GL

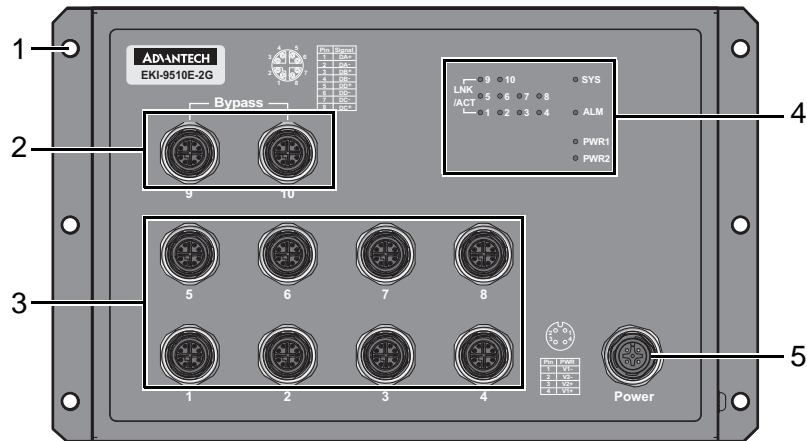

Figure 1.5 Front View

No.	Item	Description
1	Wall mounting holes	Screw holes (x6) used in the installation on wall.
2	ETH port	10/100/1000Base-T M12 x 2 (X-coding)
3	ETH port	10/100/1000Base-T M12 x 8 (X-coding)
4	System LED panel	See “System LED Panel” on page 9 for further details.
5	Power input port	M12 5-pin (male) DC power connector port.

1.2.1.6 EKI-9510G-2GMH/EKI-9510G-2GML

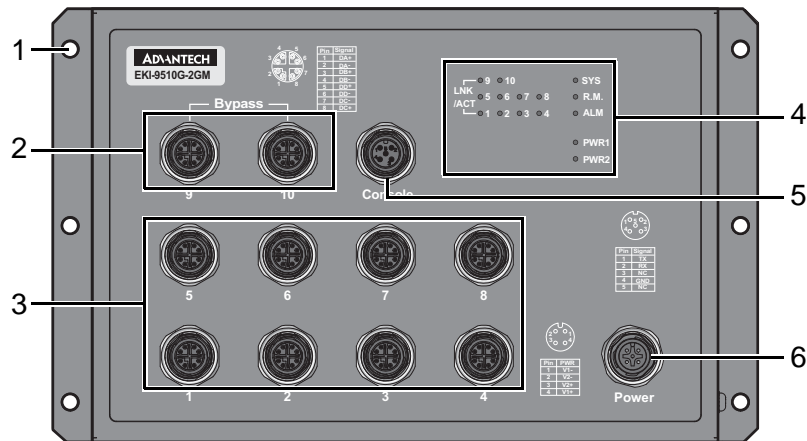

Figure 1.6 Front View

No.	Item	Description
1	Wall mounting holes	Screw holes (x6) used in the installation on wall.
2	ETH port	10/100/1000Base-T M12 x 2 (X-coding)
3	ETH port	10/100/1000Base-T M12 x 8 (X-coding)
4	System LED panel	See “System LED Panel” on page 9 for further details.
5	Console port	M12 5-pin (female) port to access the managed switch's software.
6	Power input port	M12 5-pin (male) DC power connector port.

1.2.1.7 EKI-9510G-2GMPH/EKI-9510G-2GMPL

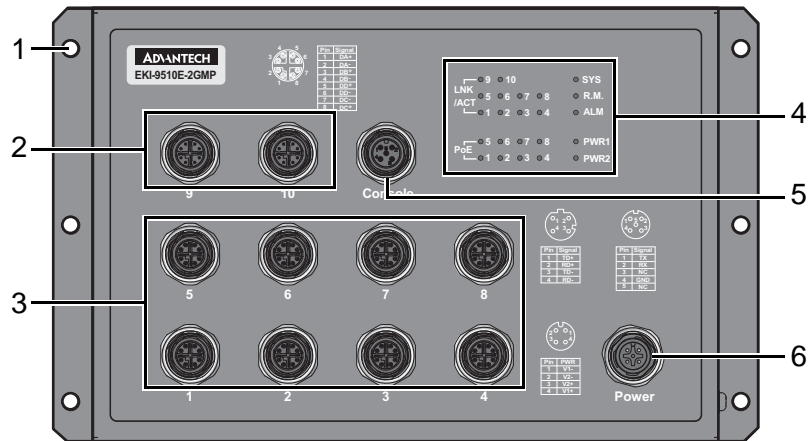

Figure 1.7 Front View

No.	Item	Description
1	Wall mounting holes	Screw holes (x6) used in the installation on wall.
2	ETH port	10/100/1000Base-T M12 x 2 (X-coding)
3	ETH port	10/100/1000Base-T M12 x 8 (X-coding)
4	System LED panel	See "System LED Panel" on page 9 for further details.
5	Console port	M12 5-pin (female) port to access the managed switch's software.
6	Power input port	M12 5-pin (male) DC power connector port.

1.2.1.8 EKI-9510G-2GPH/EKI-9510G-2GPL

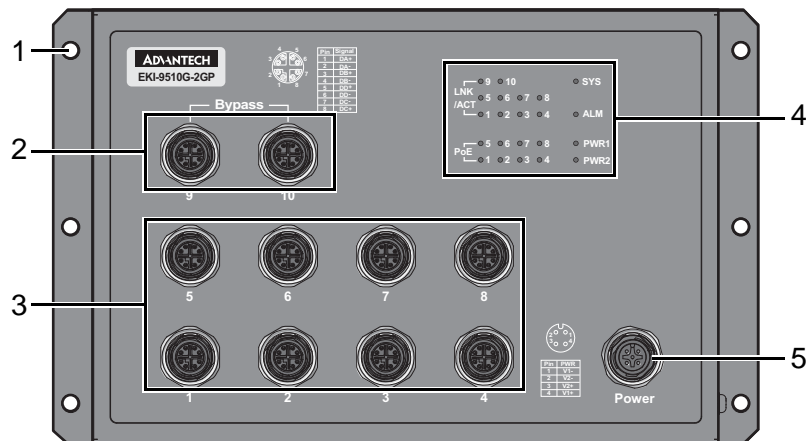

Figure 1.8 Front View

No.	Item	Description
1	Wall mounting holes	Screw holes (x6) used in the installation on wall.
2	ETH port	10/100/1000Base-T M12 x 2 (X-coding)
3	ETH port	10/100/1000Base-T M12 x 8 (X-coding)
4	System LED panel	See "System LED Panel" on page 9 for further details.
5	Power input port	M12 5-pin (male) DC power connector port.

1.2.1.9 System LED Panel

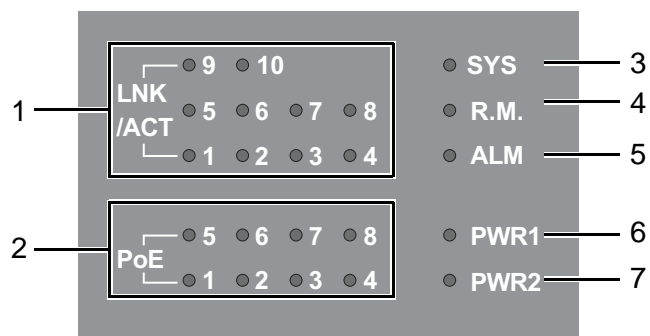

Figure 1.9 System LED Panel

No.	LED Name	LED Color	Description
1	LNK/ACT	Solid green	When there is a 1000Mbps connection (For Gigabit Ethernet Port).
		Blinking green	When there is transmission or reception of data occurring at speed of 1000Mbps (For Gigabit Ethernet Port).
		Off	No connection detected or system off.
2	PoE (only for PoE models)	Solid green	Supply PoE power.
		Off	No PoE power is supplied.
3	SYS	Solid green	System is ready.
		Off	System is initiating.
4	R.M.	Solid green	Active when determining ring master
5	ALM	Solid red	Defined major policies are detected.
		Blinking red (1Hz)	Defined minor policies are detected.
		Blinking red (3Hz)	TBD
		Blinking red (5Hz)	TBD
		Off	Power off or system alarm is cleared or masked.
6	PWR1	Solid green	Power is being supplied to power input PWR1.
		Off	Power is not being supplied to power input PWR1.
7	PWR2	Solid green	Power is being supplied to power input PWR2.
		Off	Power is not being supplied to power input PWR2.

1.3 Dimensions

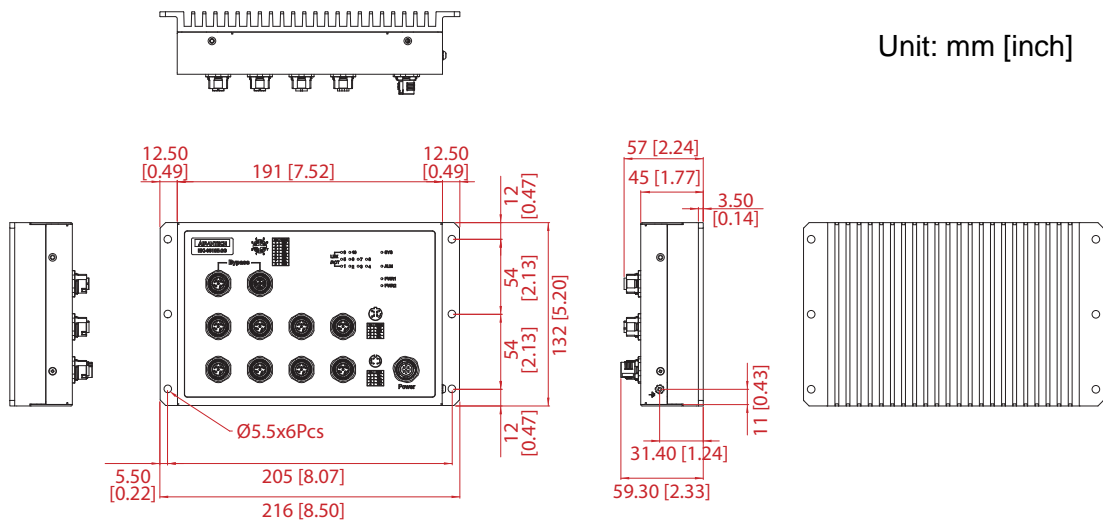

Figure 1.10 EKI-9510E-2GH/EKI-9510E-2GL Dimensions

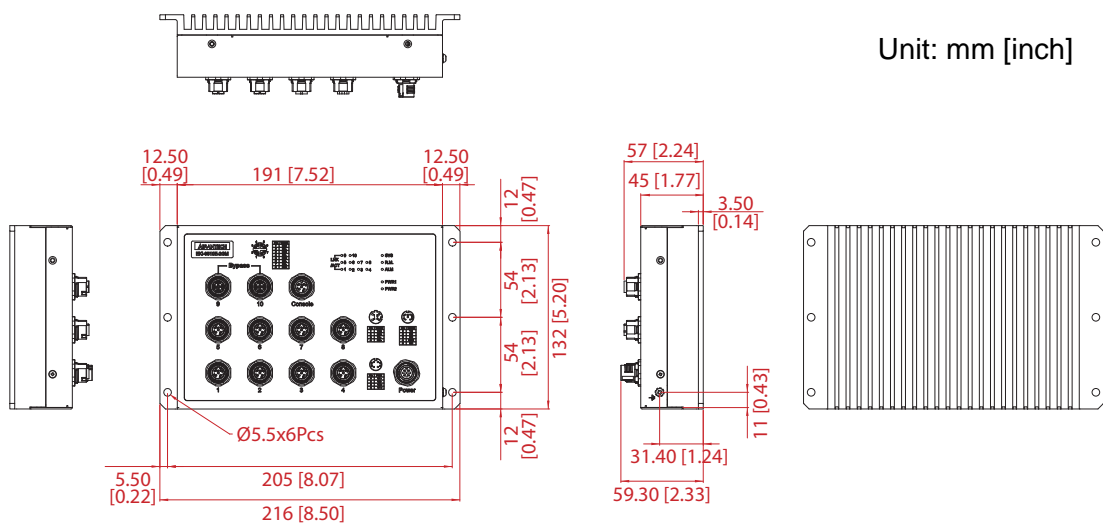

Figure 1.11 EKI-9510E-2GMH/EKI-9510E-2GML Dimensions

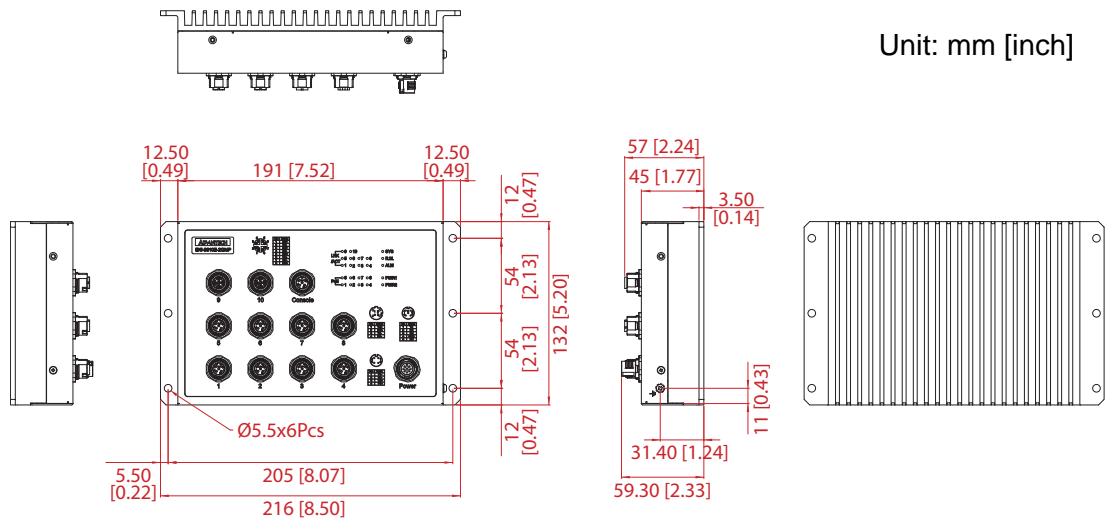

Figure 1.12 EKI-9510E-2GMPH/EKI-9510E-2GMPL Dimensions

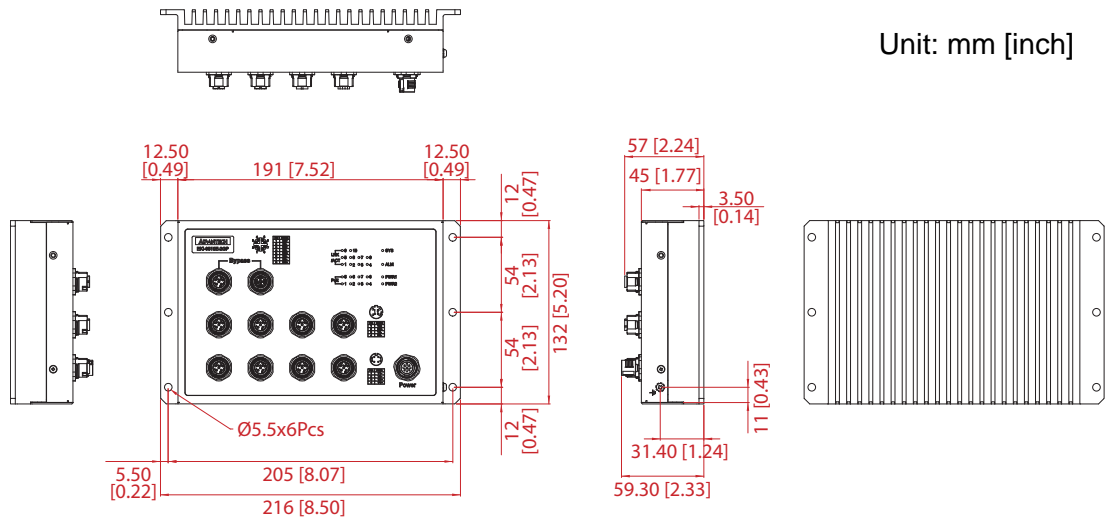

Figure 1.13 EKI-9510E-2GPH/EKI-9510E-2GPL Dimensions

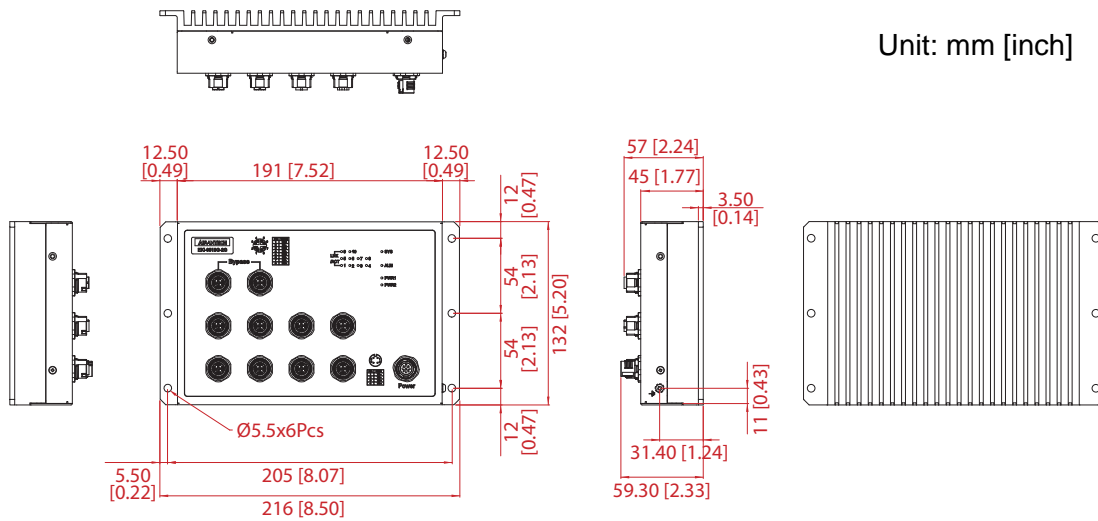

Figure 1.14 EKI-9510G-2GH/EKI-9510G-2GL Dimensions

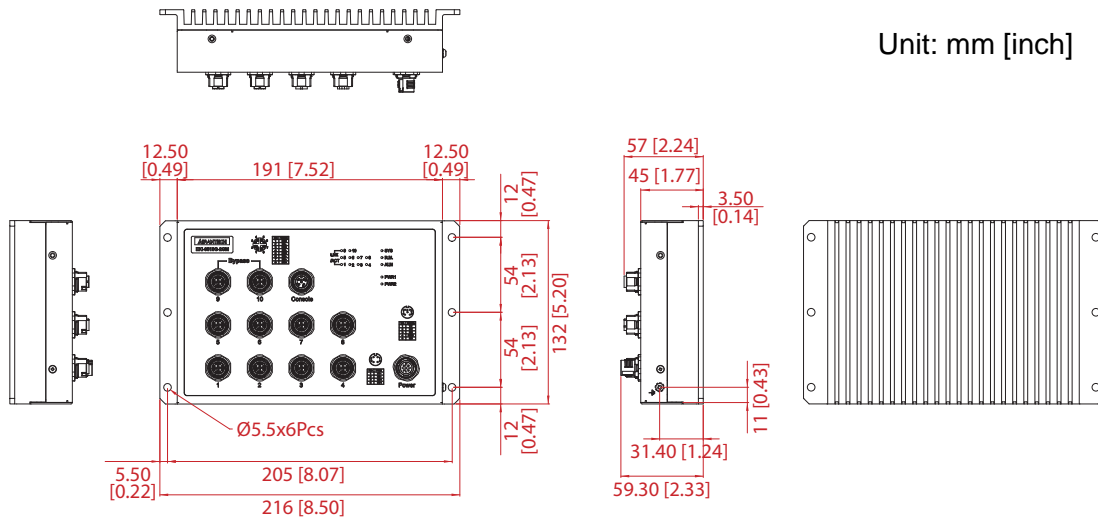

Figure 1.15 EKI-9510G-2GMH/EKI-9510G-2GML Dimensions

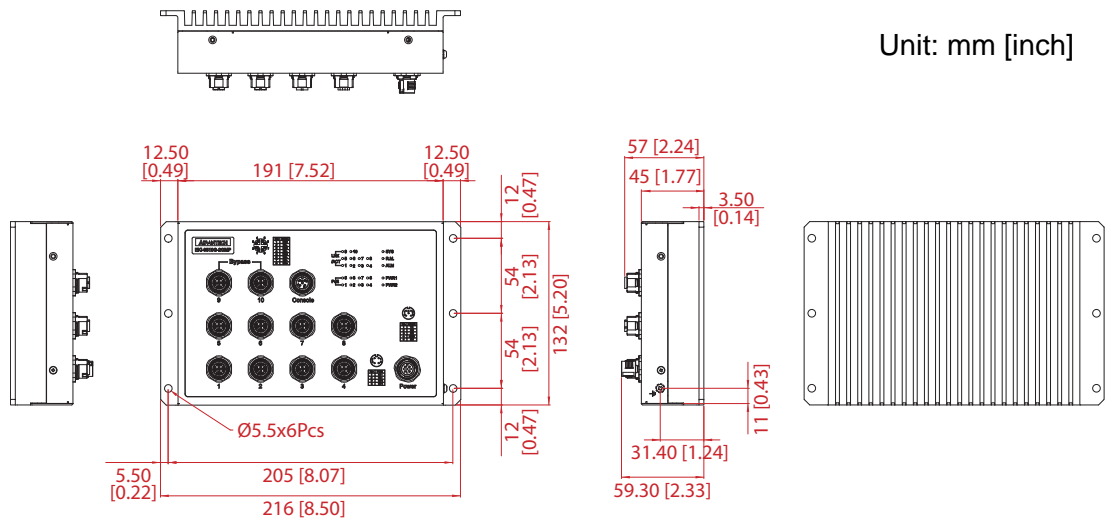

Figure 1.16 EKI-9510G-2GMPH/EKI-9510G-2GMPL Dimensions

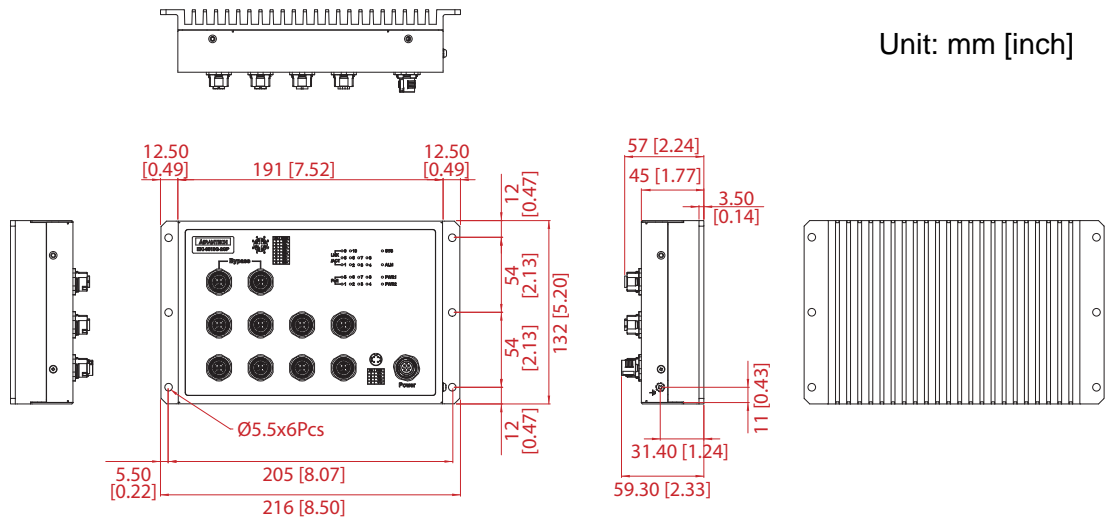

Figure 1.17 EKI-9510G-2GPH/EKI-9510G-2GPL Dimensions

Chapter 2

Switch Installation

2.1 Installation Guidelines

The following guidelines are provided to optimize the device performance. Review the guidelines before installing the device.

- Make sure cabling is away from sources of electrical noise. Radios, power lines, and fluorescent lighting fixtures can interfere with the device performance.
- Make sure the cabling is positioned away from equipment that can damage the cables.
- Operating environment is within the ranges listed range, see “Specifications” on page 2.
- Relative humidity around the switch does not exceed 95 percent (noncondensing).
- Altitude at the installation site is not higher than 10,000 feet.
- In 10/100 and 10/100/1000 fixed port devices, the cable length from the switch to connected devices can not exceed 100 meters (328 feet).
- Make sure airflow around the switch and respective vents is unrestricted. Without proper airflow the switch can overheat. To prevent performance degradation and damage to the switch, make sure there is clearance at the top and bottom and around the exhaust vents.

2.1.1 Connecting Hardware

These instructions explain how to find a proper location for your Modbus Gateways, and how to connect to the network, hook up the power cable, and connect to the EKI-9510 Series.

2.2 Verifying Switch Operation

Before installing the device in a rack or on a wall, power on the switch to verify that the switch passes the power-on self-test (POST). To connect the cabling to the power source see “Power Supply Installation” on page 17.

At startup (POST), the System LED blinks green, while the remaining LEDs are a solid green. Once the switch passes POST self-test, the System LED turns green. The other LEDs turn off and return to their operating status. If the switch fails POST, the System LED switches to an amber state.

After a successful self-test, power down the switch and disconnect the power cabling. The switch is now ready for installation at its final location.

2.3 Installing the Switch

2.3.1 Wall-Mounting

Note! When installing, make sure to allow for enough space to properly install the cabling.



1. Locate the installation site and place the switch against the wall, making sure it is the final installation location.
2. Insert the screws into the wall sinks. Leave a 4 mm gap between the wall and the screw head to allow for wall mount plate insertion.

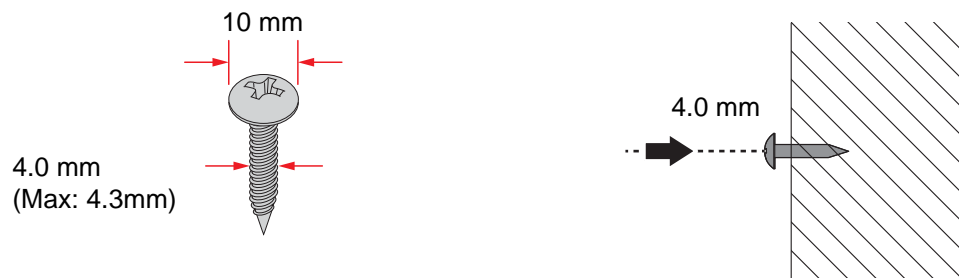

Figure 2.1 Securing Wall Mounting Screws

Note!

- Make sure the screws dimensions are suitable for use with the device.
- Do not completely tighten the screws into the wall. A final adjustment may be needed before fully securing the device on the wall.



3. Align the device over the screws on the wall.
4. Install the device on the screws and slide it downward to lock in place, see the following figure.

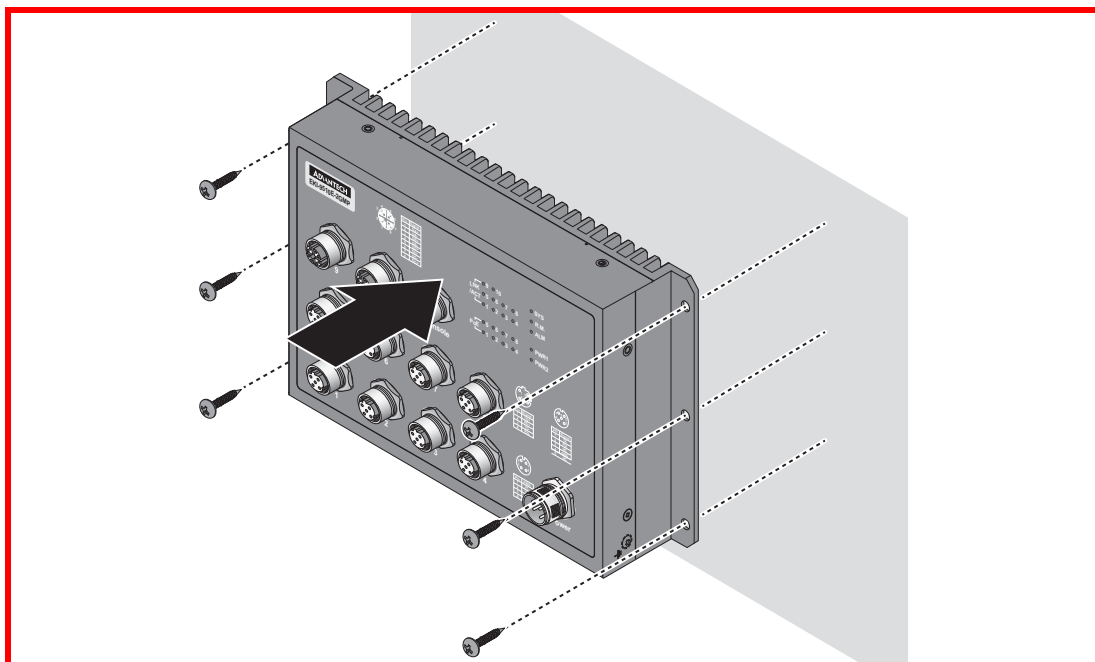

Figure 2.2 Switch Installation

5. Once the device is installed on the wall, tighten the screws to secure the device.

2.4 Power Supply Installation

2.4.1 Overview

Warning! Power down and disconnect the power cord before servicing or wiring the switch.



Caution! Do not disconnect modules or cabling unless the power is first switched off.



The device only supports the voltage outlined in the type plate. Do not use any other power components except those specifically designated for the switch device.

Caution! Disconnect the power cord before installation or cable wiring.



The switch can be powered by using the same DC source used to power other devices. A DC voltage range of 24 to 110 VDC must be applied between the V1+ terminal and the V1-terminal (PW1), see the following illustrations. The chassis ground screw terminal should be tied to the chassis ground. A redundant power configuration is supported through a secondary power supply unit to reduce network down time as a result of power loss.

EKI-9510 Series support 24 to 110 V_{DC}. Dual power inputs are supported and allow you to connect a backup power source.

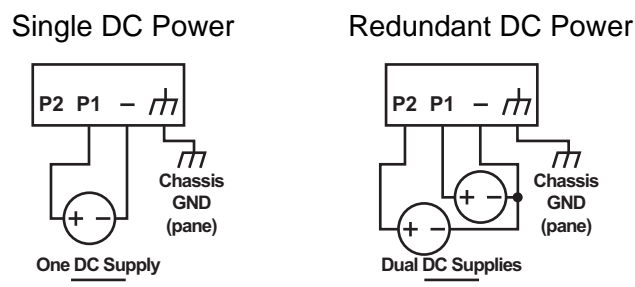

Figure 2.3 Power Wiring for EKI-9510 Series

2.4.2 Considerations

Take into consideration the following guidelines before wiring the device:

- The Terminal Block (CN1) is suitable for 12-24 AWG (3.31 - 0.205 mm²). Torque value 7 lb-in.
- The cross sectional area of the earthing conductors shall be at least 3.31 mm².
- Calculate the maximum possible current for each power and common wire. Make sure the power draw is within limits of local electrical code regulations.
- For best practices, route wiring for power and devices on separate paths.
- Do not bundle together wiring with similar electrical characteristics.
- Make sure to separate input and output wiring.
- Label all wiring and cabling to the various devices for more effective management and servicing.

Note! *Routing communications and power wiring through the same conduit may cause signal interference. To avoid interference and signal degradation, route power and communications wires through separate conduits.*



2.4.3 Grounding the Device

Caution! *Do not disconnect modules or cabling unless the power is first switched off.*



The device only supports the voltage outlined in the type plate. Do not use any other power components except those specifically designated for the switch device.

Caution! *Before connecting the device properly ground the device. Lack of a proper grounding setup may result in a safety risk and could be hazardous.*



Caution! *Do not service equipment or cables during periods of lightning activity.*



Caution! *Do not service any components unless qualified and authorized to do so.*



Caution! *Do not block air ventilation holes.*



Electromagnetic Interference (EMI) affects the transmission performance of a device. By properly grounding the device to earth ground through a drain wire, you can setup the best possible noise immunity and emissions.

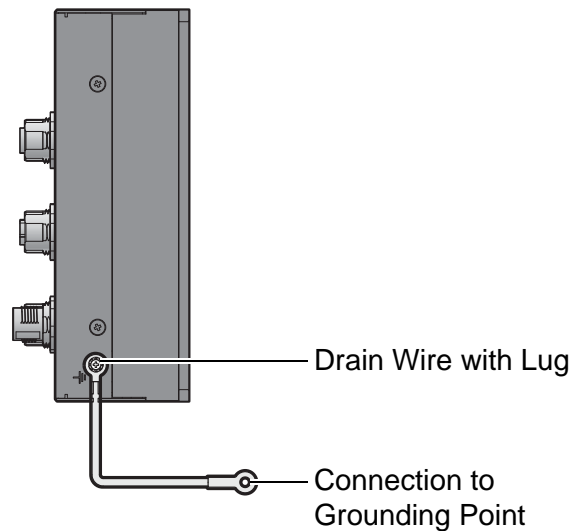

Figure 2.4 Grounding Connection, Chassis Left Side View

By connecting the ground terminal by drain wire to earth ground the switch and chassis can be ground.

Note! *Before applying power to the grounded switch, it is advisable to use a volt meter to ensure there is no voltage difference between the power supply's negative output terminal and the grounding point on the switch.*



2.4.4 Wiring the Power Inputs

Caution! *Do not disconnect modules or cabling unless the power is first switched off.*



The device only supports the voltage outlined in the type plate. Do not use any other power components except those specifically designated for the switch device.

Warning! *Power down and disconnect the power cord before servicing or wiring the switch.*



To wire the power inputs:

Make sure the power cable is not connected to the switch or the power converter before proceeding.

1. Align the notch on the cable with the protrusion on the connector port. Before inserting the cable, the cable must be aligned to the connector to prevent damage to the pins in the port.
2. Insert the cable and gently push it in. If there is any resistance, remove the cable and re-align it with the connector.
3. Once the cable is fully seated in the port, turn the nut on the cable to secure it to the connector.

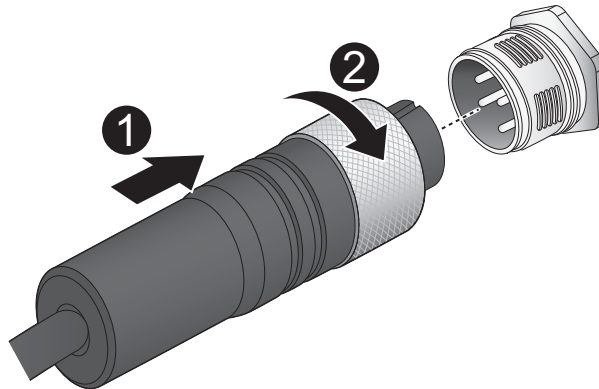

Figure 2.5 Installing the Power Cable

The power input is now connected to the switch. The switch can be powered on.

2.4.4.1 Standard M12 4-Pin Female Pin Assignment

This section describes the proper connection of the 24, 48, 72, 96 and 110 V_{DC} to the DC power connector on the switch. The DC input connector is located on the left side of the front panel. The power terminals are connected as shown in the following figure. They are electrically floating inside the unit so that either may be grounded by the user if desired. The chassis is earthed or ground (GND).

The mating connection to the switch is created through a RD24, female connector. Simply align the keyed female connector to the male connector and twist the threaded to secure.

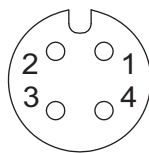

Figure 2.6 Standard M12 4-Pin Female DC Power Input Connector

Pin	Description
1	V1-
2	V2-
3	V2+
4	V1+

2.5 Connecting the Ethernet Media

2.5.1 Connecting the 10/100Mbps Ports

The managed Ethernet models have Fast Ethernet ports (4-pin shielded M12 connector with D coding) circular connectors. The 10/100Mbps ports located on the switch's front side are used to connect to Ethernet-enabled devices.

2.5.1.1 M12 D-Coded Connector Pin Assignment

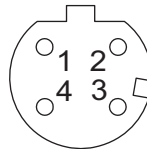

Figure 2.7 M12 D-Coded Connector Pin Assignment

Pin	Description
1	TD+
2	RD+
3	TD-
4	RD-

2.5.2 Connecting the 10/100/1000Mbps Ports

The managed Ethernet models have Gigabit Ethernet ports (8-pin shielded M12 connector with X coding) circular connectors. The 10/100/1000Mbps ports located on the switch's front side are used to connect to Ethernet-enabled devices.

2.5.2.1 M12 X-Coded Connector Pin Assignment

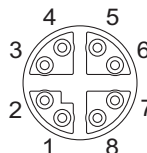

Figure 2.8 M12 X-Coded Connector Pin Assignment

Pin	Description
1	DA+
2	DA-
3	DB+
4	DB-
5	DD+
6	DD-
7	DC-
8	DC+

2.6 Connecting the Console Terminal

The console port, used to access the managed switch's software, has an 5-pin M12 (female) port. A console cable with the mating M12 (male) port and both a DB-9 and / or a USB connector is available for purchase from Advantech.

2.6.1 M12 A-Coded Connector Pin Assignment

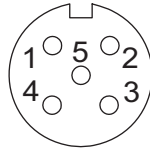

Figure 2.9 M12 A-Coded Connector Pin Assignment

Pin	Description
1	TX
2	RX
3	N/A
4	GND
5	N/A

Chapter 3

Configuration Utility

3.1 First Time Setup

3.1.1 Overview

The Industrial Ethernet Managed Switch is a configurable device that facilitates the interconnection of Ethernet devices on an Ethernet network. This includes computers, operator interfaces, I/O, controllers, RTUs, PLCs, other switches/hubs or any device that supports the standard IEEE 802.3 protocol.

This switch has all the capabilities of a store and forward Ethernet switch plus advanced management features such as SNMP, RSTP and port mirroring. This manual details how to configure the various management parameters in this easy to use switch.

3.1.2 Introduction

To take full advantage of all the features and resources available from the switch, it must be configured for your network.

The switch implements Rapid Spanning Tree Protocol (RSTP) and Simple Network Management Protocol (SNMP) to provide most of the services offered by the switch. Rapid Spanning Tree Protocol allows managed switches to communicate with each other to ensure that there exists only one active route between each pair of network nodes and provides automatic failover to the next available redundant route. A brief explanation of how RSTP works is given in the Spanning Tree section.

The switch is capable of communicating with other SNMP capable devices on the network to exchange management information. This statistical/derived information from the network is saved in the Management Information Base (MIB) of the switch. The MIB is divided into several different information storage groups. These groups will be elaborated in detail in the Management and SNMP information section of this document. The switch implements Internet Group Management Protocol (IGMP) to optimize the flow of multicast traffic on your network.

The switch supports both port-based and tag-based Virtual LANs for flexible integration with VLAN-aware networks with support for VLAN-unaware devices.

3.1.3 Administrative Interface Access

There are several administrative interfaces to the switch:

A graphical web interface accessible via the switch's built-in web server. Both HTTP and secure HTTPS with SSL are supported.

Note! *This is the recommended method for managing the switch.*



A terminal interface or over the network using telnet or Secure Shell (SSH) connected through the console (M12 A-Coded) port.

An SNMP interface can be used to read/write many settings.

Command Line Interface (CLI) can be used to read/write most settings. Initial setup must be done using an Ethernet connection (recommended) or the serial port.

3.1.4 Using the Graphical (Web) Interface

The graphical interface is provided via a web server in the switch and can be accessed via a web browser such as Opera, Mozilla, or Internet Explorer.

Note! *JavaScript must be supported and enabled in your browser for the graphical interface to work correctly.*



HTTP and HTTPS (secure HTTP) are supported for access to the web server. By default, both protocols are enabled. Either or both may be disabled to secure the switch. (See the Remote Access Security topic in this section.)

To access the graphical interface, enter the default IP setting (`http://192.168.1.1`) in your browser's address bar. Replace “http” with “https” to use secure http and replace “192.168.1.1” with your switch's IP address if you've changed it from the factory default.

The web server in the switch uses a signed security certificate. When you access the server via https, you may see a warning dialog indicating that the certificate was signed by an unknown authority. This is expected and to avoid this message in the future you can choose to install the certificate on your computer.

Note! *This manual describes and depicts the web user interface in detail. The terminal interface is not specifically shown.*



3.1.5 Configuring the Switch for Network Access

To control and monitor the switch via the network, it must be configured with basic network settings, including an IP address and subnet mask. Refer to the quick start guide in Section 1 for how to initially access your switch.

To configure the switch for network access, select [Add Menu Address Here] to reach the System Settings menu. The settings in this menu control the switch's general network configuration.

- DHCP Enabled/Disabled: The switch can automatically obtain an IP address from a server using the Dynamic Host Configuration Protocol (DHCP). This can speed up initial set up, as the network administrator does not have to find an open IP address.
- IP Address and subnet mask configuration: The IP address for the switch can be changed to a user-defined address along with a customized subnet mask to separate subnets.

Note! *Advanced users can set the IP address to 0.0.0.0 to disable the use of an IP address for additional security. However, any features requiring an IP address (i.e., web interface, etc.) will no longer be available.*



- Default Gateway Selection: A Gateway Address is chosen to be the address of a router that connects two different networks. This can be an IP address or a Fully Qualified Domain Name (FQDN) such as “domainname.org”.
- NTP Server: The IP address or domain name of an NTP (Network Time Protocol) server from which the switch may retrieve the current time at startup.

Please note that using a domain name requires that at least one domain name server be configured.

3.1.6 Configuring the Ethernet Ports

The switch comes with default port settings that should allow you to connect to the Ethernet Ports with out any necessary configuration. Should there be a need to change the name of the ports, negotiation settings or flow control settings, you can do this in the Port Configuration menu. Access this menu by selecting Setup from the Main menu, and then selecting Main Settings.

- Port Name: Each port in the managed switch can be identified with a custom name. Specify a name for each port here.
- Admin: Ports can be enabled or disabled in the managed switch. For ports that are disabled, they are virtually non-existent (not visible in terms of switch operation or spanning tree algorithm). Choose to enable or disable a port by selecting Enabled or Disabled, respectively.
- Negotiation: All copper ports and gigabit fiber ports in the managed switch are capable of autonegotiation such that the fastest bandwidth is selected. Choose to enable auto-negotiation or use fixed settings. 100Mbps Fiber ports are Fixed speed only.
- Speed/Duplex/Flow Control: The managed switch accepts three local area network Ethernet Standards. The first standard, 10BASE-T, runs 10Mbps with twisted pair Ethernet cable between network interfaces. The second local area network standard is 100BASE-T, which runs at 100Mbps over the same twisted pair Ethernet cable. Lastly, there is 100BASE-F, which enables fast Ethernet (100Mbps) over fiber.

These options are available:

- 10h–10 Mbps, Half Duplex
- 10f –10 Mbps, Full Duplex
- 100h–100 Mbps, Half Duplex
- 100f –100 Mbps, Full Duplex
- 1000f–1000 Mbps, Full Duplex

On managed switches with gigabit combination ports, those ports with have two rows, a standard row of check boxes and a row labeled “SFP” with radio buttons. The SFP setting independently sets the speed at which a transceiver will operate if one is plugged in. Otherwise, the switch will use the fixed Ethernet port and the corresponding settings for it.

Note! *When 100f is selected for the SFP of a gigabit combination port, the corresponding fixed Ethernet jack will be disabled unless it is changed back to 1000F.*



3.2 Command Line Interface Configuration

3.2.1 Introduction to Command-Line Interface (CLI)

The command-line interface (CLI) is constructed with an eye toward automation of CLI-based configuration. The interaction is modeled on that used in many Internet protocols such as Telnet, FTP, and SMTP. After each command is entered and processed, the switch will issue a reply that consists of a numeric status code and a human-readable explanation of the status.

The general format of commands is:

```
section parameter [value]
```

where:

- section is used to group parameters.
- parameter will specify the parameter within the section. For example, the network section will have parameters for DHCP, IP address, subnet mask, and default gateway.
- value is the new value of the parameter. If value is omitted, the current value is displayed.

Please note that new values will not take effect until explicitly committed.

Sections and parameter names are case sensitive (e.g., “Network” is not the same as “network”).

Note! *Any commands in the CLI Commands section of this chapter, with the exception of the global commands, must be prefaced with the name of the section they are in. For example, to change the IP address of the switch, you would type:*



```
network address <newIP>
```

3.2.2 Accessing the CLI

To access the CLI interface, establish Ethernet or serial connectivity to the switch.

To connect by Ethernet, open a command prompt window and type:

```
telnet <switchip> (where <switchip> is the IP address of the switch)
```

At the login prompt, type “cli” for the username and “admin” for the password. The switch will respond with “Managed switch configuration CLI ready”.

3.3 Web Browser Configuration

The switch has an HTML based user interface embedded in the flash memory. The interface offers an easy to use means to manage basic and advanced switch functions. The interface allows for local or remote switch configuration anywhere on the network. The interface is designed for use with [Internet Explorer (6.0), Chrome, Firefox].

3.3.1 Preparing for Web Configuration

The interface requires the installation and connection of the switch to the existing network. A PC also connected to the network is required to connect to the switch and access the interface through a web browser. Use this networking information:

- IP address: 192.168.1.1
- Subnet mask: 255.255.255.0
- Default gateway: 192.168.1.254
- User name: admin
- Password: admin

3.3.2 System Login

Once the switch is installed and connected, power on the switch. The following information guides you through the logging in process.

1. Launch your web browser.
2. In the browser's address bar, type the switch's default IP address (192.168.1.1). The login screen displays.
3. Enter the user default name and password (admin / admin).
4. Click **OK** on the login screen to log in.

The main interface displays.

Chapter 4

Managing Switch

4.1 Log In

To access the login window, connect the device to the network, see “Connecting the Ethernet Media” on page 21. Once the switch is installed and connected, power on the switch see the following procedures to log into your switch.

When the switch is first installed, the default network configuration is set to DHCP enabled. You will need to make sure your network environment supports the switch setup before connecting it to the network.

1. Launch your web browser on a computer.
2. In the browser’s address bar type in the switch’s default IP address (192.168.1.1). The login screen displays.
3. Enter the default user name and password (admin/admin) to log into the management interface. You can change the default password after you have successfully logged in.
4. Click **Login** to enter the management interface.

The image shows a web-based login interface. It features a light yellow background with a blue border. At the top, the word "Username" is written in blue. Below it is a white rectangular input field. Underneath that, the word "Password" is written in blue, followed by another white rectangular input field. At the bottom center, there is a blue button with the word "Login" written in white.

Figure 4.1 Login Screen

4.2 Recommended Practices

One of the easiest things to do to help increase the security posture of the network infrastructure is to implement a policy and standard for secure management. This practice is an easy way to maintain a healthy and secure network.

After you have performed the basic configurations on your switches, the following is a recommendation which is considered best practice policy.

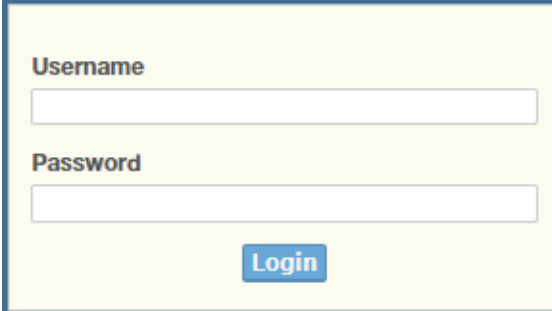
4.2.1 Changing Default Password

In keeping with good management and security practices, it is recommended that you change the default password as soon as the device is functioning and setup correctly. The following details the necessary steps to change the default password.

To change the password:

1. Navigate to **Tools > User Account**.
2. From the User drop-down menu, select the Admin (default) account.
3. In the **User Name** field, enter admin for this account. It is not necessary to change the user name, however, a change in the default settings increases the security settings.
4. In the **Password** field, type in the new password. Re-type the same password in the **Retype Password** field.

- Click **Apply** to change the current account settings.

The screenshot shows a web form titled "Add/Edit User". It contains the following fields:

- User Name:** A text input field with the placeholder text "Input name".
- Password Type:** A dropdown menu currently set to "Clear Text".
- Password:** A text input field with the placeholder text "Input password".
- Retype Password:** A text input field with the placeholder text "Input password".
- Privilege Type:** A dropdown menu currently set to "Admin".

 Below the fields is a blue button labeled "Apply".

Figure 4.2 Changing a Default Password

After saving all the desired settings, perform a system save (**Tools > Save Configuration**). The changes are saved.

4.3 Monitoring

4.3.1 Device Information

The Device Information menu lists information, such as: System Name, System Location, MAC Address, Firmware version, and more, pertaining to the system. The information is for review only. To modify the device information, see the respective item within the user interface.

To access this page, click **Monitoring > Device Information**.

The screenshot shows a table titled "Device Information" with the following data:

Information Name	Information Value
System Name	Switch
System Location	Default
System Contact	Default
MAC Address	00:D0:C9:F5:31:0B
IP Address	192.168.1.156
Subnet Mask	255.255.255.0
Gateway	192.168.1.1
Loader Version	1.0.0.48895
Loader Date	Sep 02 2015 - 13:26:50
Firmware Version	1.00.21
Firmware Date	Sep 02 2015 - 13:27:32
System Object ID	1.3.6.1.4.1.10297.202.7000
System Up Time	0 days, 4 hours, 31 mins, 13 secs

Figure 4.3 Monitoring > Device Information

The following table describes the items in the previous figure.

Item	Description
System Name	Click Switch to enter the system name: up to 128 alphanumeric characters (default is Switch).
System Location	Click Default to enter the location: up to 256 alphanumeric characters (default is Default).
System Contact	Click Default to enter the contact person: up to 128 alphanumeric characters (default is Default).
MAC Address	Displays the MAC address of the switch.
IP Address	Displays the assigned IP address of the switch.
Subnet Mask	Displays the assigned subnet mask of the switch.
Gateway	Displays the assigned gateway of the switch.
Loader Version	Displays the current loader version of the switch.
Loader Date	Displays the current loader build date of the switch.
Firmware Version	Displays the current firmware version of the switch.
Firmware Date	Displays the current firmware build date of the switch.
System Object ID	Displays the base object ID of the switch.
System Up Time	Displays the time since the last switch reboot.

4.3.2 Logging Message

The Logging Message Filter page allows you to enable the display of logging message filter.

To access this page, click **Monitoring > Logging Message**.

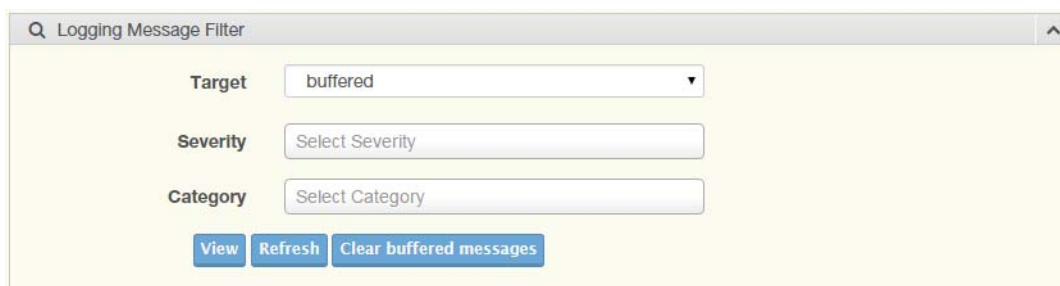

Figure 4.4 Monitoring > Logging Message

The following table describes the items in the previous figure.

Item	Description
Target	Click the drop-down menu to select a target to store the log messages. <ul style="list-style-type: none"> ■ Buffered: Store log messages in RAM. All log messages are cleared after system reboot. ■ File: Store log messages in a file.

Item	Description
Severity	The setting allows you to designate a severity level for the Logging Message Filter function. Click the drop-down menu to select the severity level target setting. The level options are: <ul style="list-style-type: none"> ■ emerg: Indicates system is unusable. It is the highest level of severity. ■ alert: Indicates action must be taken immediately. ■ crit: Indicates critical conditions. ■ error: Indicates error conditions. ■ warning: Indicates warning conditions. ■ notice: Indicates normal but significant conditions. ■ info: Indicates informational messages. ■ debug: Indicates debug-level messages.
Category	Click the drop-down menu to select the category level target setting.
View	Click View to display all Logging Information and Logging Message information.
Refresh	Click Refresh to update the screen.
Clear buffered messages	Click Clear buffered messages to clear the logging buffer history list.

The ensuing table for **Logging Information** table settings are informational only: Target, Severity and Category.

The ensuing table for **Logging Message** table settings are informational only: No., Time Stamp, Category, Severity and Message.

4.3.3 Port Monitoring

Port Network Monitor is a bandwidth and network monitoring tool for the purpose of capturing network traffic and measuring of network throughput. The monitoring functionality includes listing of port statistics as well as port utilization.

4.3.3.1 Port Statistics

To access this page, click **Monitoring > Port Monitoring > Port Statistics**.



Figure 4.5 Monitoring > Port Monitoring > Port Statistics

The following table describes the items in the previous figure.

Item	Description
Port	Click the drop-down menu to select a port and its captured statistical setting values.
Clear	Click Clear to clear the counter selections.

The ensuing table for **IF MIB Counters** settings are informational only: ifInOctets, ifInUcastPkts, ifInNUcastPkts, ifInDiscards, ifOutOctets, ifOutUcastPkts, ifOutNUcastPkts, ifOutDiscards, ifInMulticastPkts, ifInBroadcastPkts, ifOutMulticastPkts and ifOutBroadcastPkts.

The ensuing table for **Ether-Like MIB Counters** settings are informational only: dot3StatsAlignmentErrors, dot3StatsFCSErrors, dot3StatsSingleCollisionFrames, dot3StatsMultipleCollisionFrames, dot3StatsDeferredTransmissions, dot3StatsLateCollisions, dot3StatsExcessiveCollisions, dot3StatsFrameTooLongs, dot3StatsSymbolErrors, dot3ControlInUnknownOpcodes, dot3InPauseFrames and dot3OutPauseFrames.

The ensuing table for **Rmon MIB Counters** settings are informational only: etherStatsDropEvents, etherStatsOctets, etherStatsPkts, etherStatsBroadcastPkts, etherStatsMulticastPkts, etherStatsCRCAlignErrors, etherStatsUnderSizePkts, etherStatsOverSizePkts, etherStatsFragments, etherStatsJabbers, etherStatsCollisions, etherStatsPkts64Octets, etherStatsPkts65to127Octets, etherStatsPkts128to255Octets, etherStatsPkts256to511Octets, etherStatsPkts512to1023Octets and etherStatsPkts1024to1518Octets.

4.3.3.2 Port Utilization

To access this page, click **Monitoring > Port Monitoring > Port Utilization**.

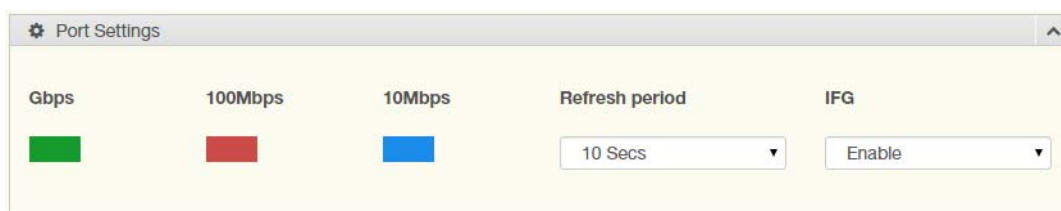

Figure 4.6 Monitoring > Port Monitoring > Port Utilization

The following table describes the items in the previous figure.

Item	Description
Refresh period	Click the drop-down menu to select and designate a period (second intervals) to refresh the information (TX and RX) listings.
IFG	Click the drop-down menu to enable or disable the Interframe Gap (IFG) statistic.

4.3.4 Link Aggregation

The Link Aggregation function provides LAG information for each trunk. It displays membership status, link state and membership type for each port.

To access this page, click **Monitoring > Link Aggregation**.

The ensuing table for **Link Aggregation Group Status** settings are informational only: LAG, Name, Type, Link State, Active Member and Standby Member.

The ensuing table for **LACP Information** settings are informational only: LAG, Port, PartnerSysId, PnKey, AtKey, Sel, Mux, Receiv, PrdTx, AtState and PnState.

4.3.5 LLDP Statistics

The LLDP Statistics page displays the LLDP statistics.

To access this page, click **Monitoring > LLDP Statistics**.

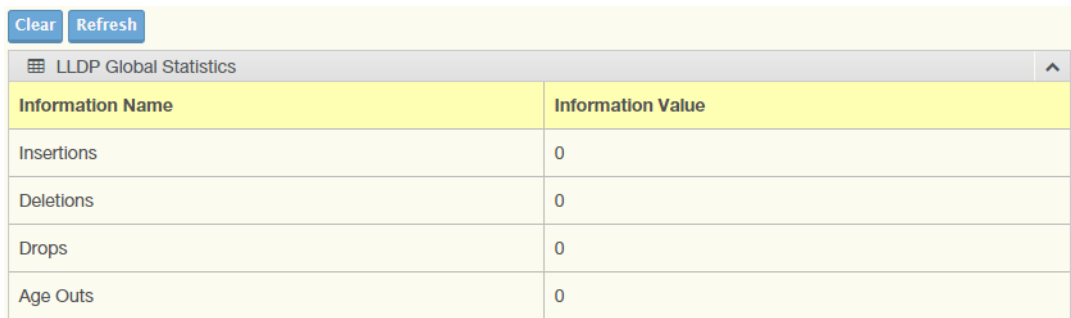

Information Name	Information Value
Insertions	0
Deletions	0
Drops	0
Age Outs	0

Figure 4.7 Monitoring > LLDP Statistics

The following table describes the items in the previous figure.

Item	Description
Clear	Click Clear to reset LLDP Statistics of all the interfaces.
Refresh	Click Refresh to update the data on the screen with the present state of the data in the switch.

The ensuing table for **LLDP Global Statistics** settings are informational only: Insertions, Deletions, Drops and Age Outs.

The ensuing table for **LLDP Port Statistics** settings are informational only: Port, TX Frames (Total), RX Frames (Total, Discarded and Errors), RX TLVs (Discarded and Unrecognized) and RX Ageouts (Total).

4.3.6 IGMP Statistics

The IGMP Statistics function displays statistical package information for IP multicasting.

To access this page, click **Monitoring > IGMP Statistics**.

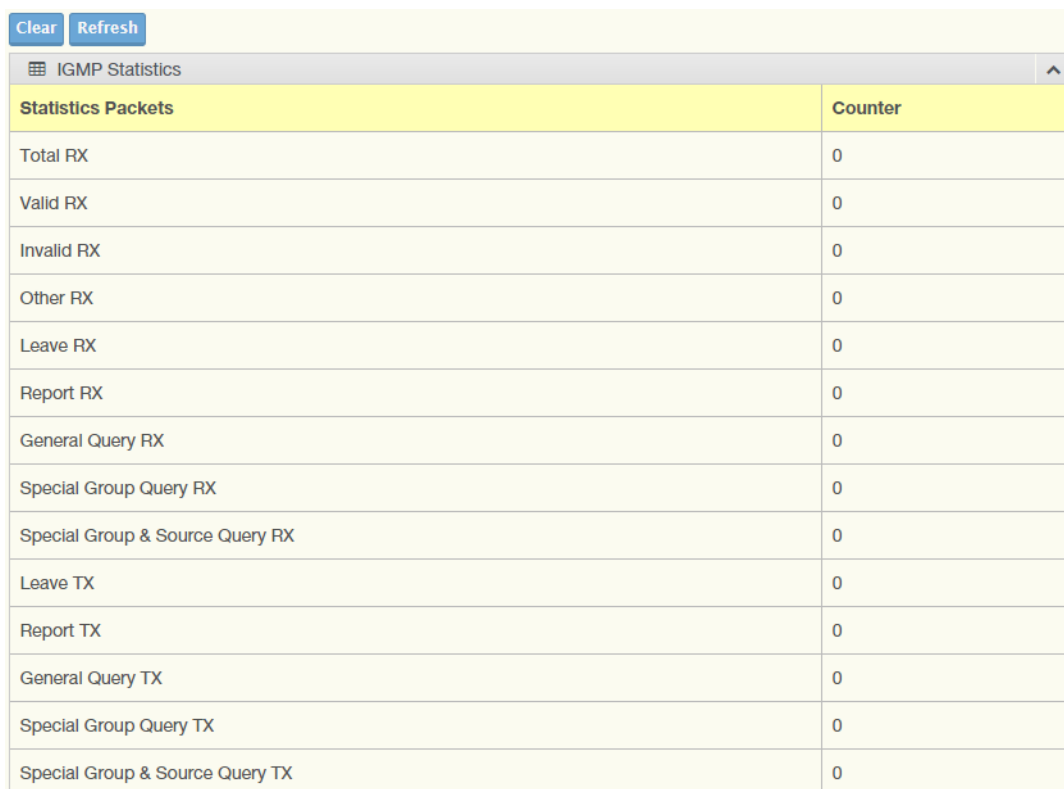

Statistics Packets	Counter
Total RX	0
Valid RX	0
Invalid RX	0
Other RX	0
Leave RX	0
Report RX	0
General Query RX	0
Special Group Query RX	0
Special Group & Source Query RX	0
Leave TX	0
Report TX	0
General Query TX	0
Special Group Query TX	0
Special Group & Source Query TX	0

Figure 4.8 Monitoring > IGMP Statistics

The following table describes the items in the previous figure.

Item	Description
Clear	Click Clear to refresh IGMP Statistics of all the interfaces.
Refresh	Click Refresh to update the data on the screen with the present state of the data in the switch.

The ensuing table for **IGMP Statistics** settings are informational only: Total RX, Valid RX, Invalid RX, Other RX, Leave RX, Report RX, General Query RX, Special Group Query RX, Special Group & Source Query RX, Leave TX, Report TX, General Query TX, Special Group Query TX and Special Group & Source Query TX.

4.3.7 MLD Statistics

The MLD Statistics function displays statistical package information for MLD message.

To access this page, click **Monitoring > MLD Statistics**.

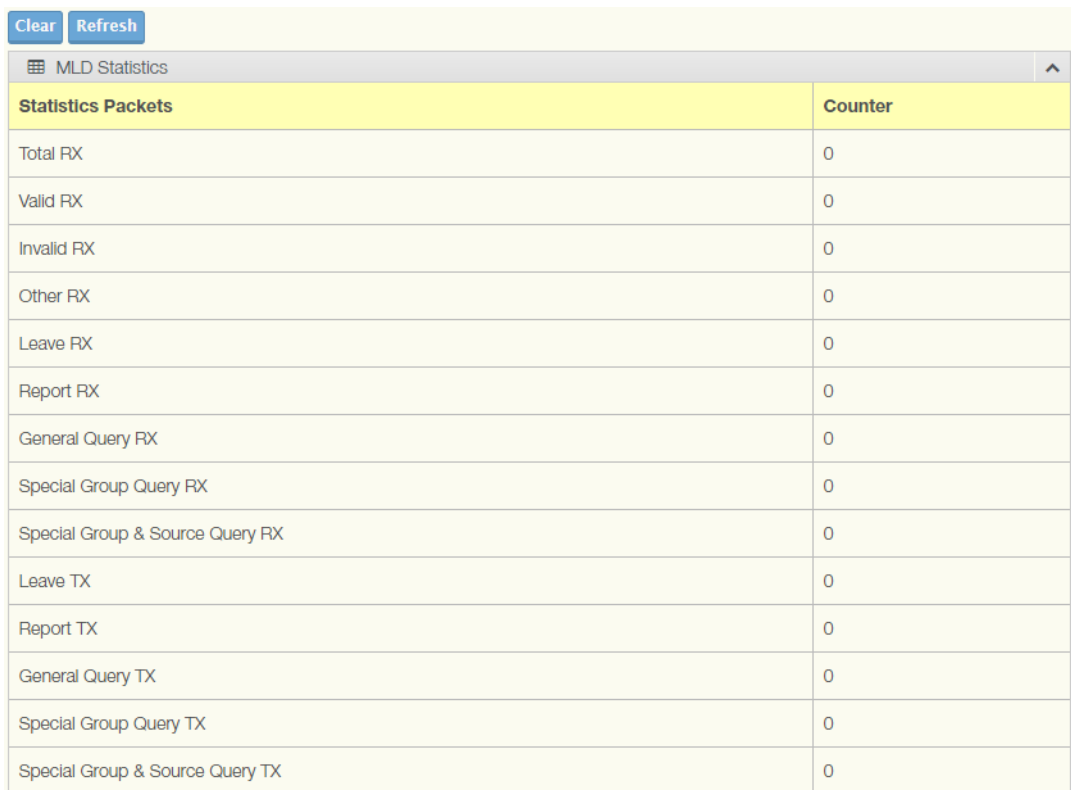

Statistics Packets	Counter
Total RX	0
Valid RX	0
Invalid RX	0
Other RX	0
Leave RX	0
Report RX	0
General Query RX	0
Special Group Query RX	0
Special Group & Source Query RX	0
Leave TX	0
Report TX	0
General Query TX	0
Special Group Query TX	0
Special Group & Source Query TX	0

Figure 4.9 Monitoring > MLD Statistics

The following table describes the items in the previous figure.

Item	Description
Clear	Click Clear to refresh MLD Statistics of all the interfaces.
Refresh	Click Refresh to update the data on the screen with the present state of the data in the switch.

The ensuing table for **IGMP Statistics** settings are informational only: Total RX, Valid RX, Invalid RX, Other RX, Leave RX, Report RX, General Query RX, Special Group Query RX, Special Group & Source Query RX, Leave TX, Report TX, General Query TX, Special Group Query TX and Special Group & Source Query TX.

4.4 System

4.4.1 IP Settings

The IP Settings menu allows you to select a static or DHCP network configuration. The Static displays the configurable settings for the static option.

To access this page, click **System > IP Settings**.

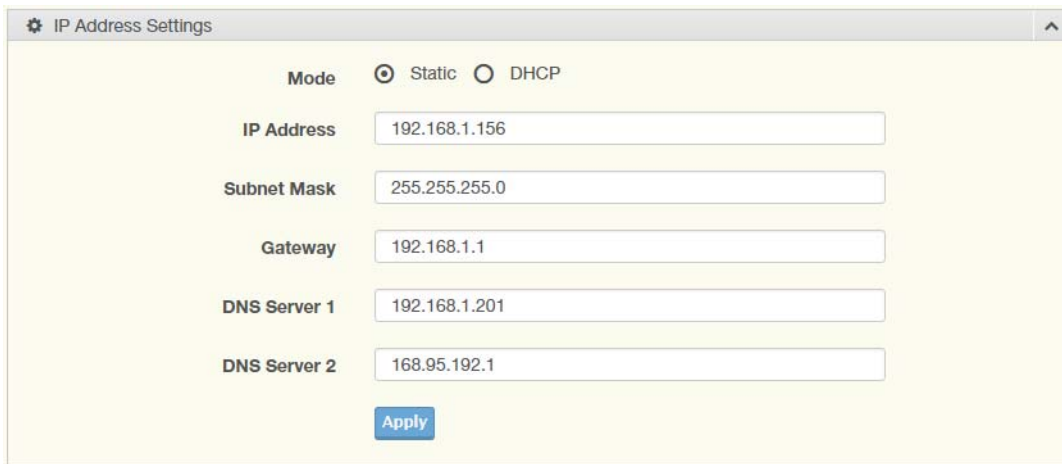

Figure 4.10 System > IP Settings

The following table describes the items in the previous figure.

Item	Description
Mode	Click the radio button to select the IP Address Setting mode: Static or DHCP.
IP Address	Enter a value to specify the IP address of the interface. The default is 192.168.1.1.
Subnet Mask	Enter a value to specify the IP subnet mask for the interface. The default is 255.255.255.0.
Gateway	Enter a value to specify the default gateway for the interface. The default is 192.168.1.254.
DNS Server 1	Enter a value to specify the DNS server 1 for the interface. The default is 168.95.1.1.
DNS Server 2	Enter a value to specify the DNS server 2 for the interface. The default is 168.95.192.1.
Apply	Click Apply to save the values and update the screen.

The ensuing table for **IP Address Information** settings are informational only: DHCP State, Static IP Address, Static Subnet Mask, Static Gateway, Static DNS Server 1 and Static DNS Server 2.

4.4.2 IPv6 Settings

To access this page, click **System > IPv6 Settings**.

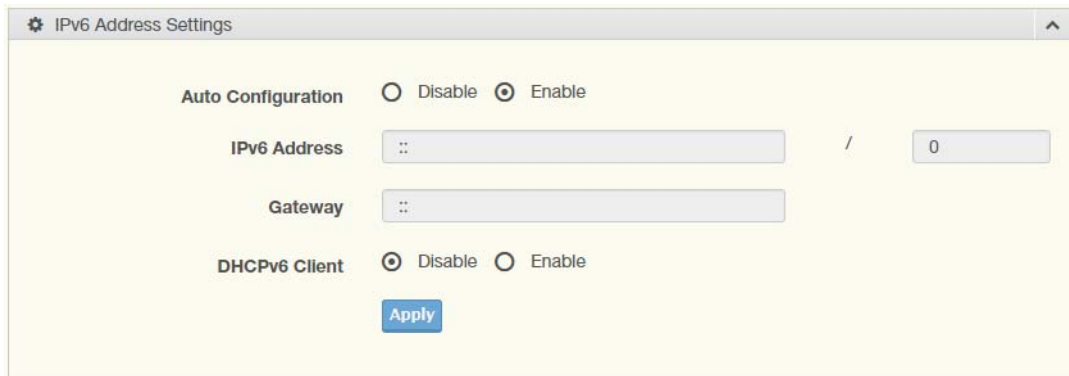

Figure 4.11 System > IPv6 Settings

The following table describes the items in the previous figure.

Item	Description
Auto Configuration	Select the radio button to enable or disable the IPv6.
IPv6 Address	Enter the IPv6 address for the system.
Gateway	Enter the gateway address for the system.
DHCPv6 Client	Enter the DHCPv6 address for the system.
Apply	Click Apply to save the values and update the screen.

The ensuing table for **IPv6 Information** settings are informational only: Auto Configuration, IPv6 In Use Address, IPv6 In Use Router, IPv6 Static Address, IPv6 Static Router and DHCPv6 Client.

4.4.3 DHCP Client Option 82

The DHCP Client Option 82 configurable Circuit ID and Remote ID feature enhances validation security by allowing you to select naming choices suboptions. You can select a switch-configured hostname or specify an ASCII test string for the remote ID. You can also configure an ASCII text string to override the circuit ID.

To access this page, click **System > DHCP Client Option 82**.

Figure 4.12 System > DHCP Client Option 82

The following table describes the items in the previous figure.

Item	Description
Mode	Click the radio button to enable or disable the DHCP Client Option 82 mode.
Circuit ID Format	Click the drop-down menu to set the ID format: String, Hex, User Definition.
Circuit ID String	Enter the string ID of the corresponding class.
Circuit ID Hex	Enter the hex string of the corresponding class.
Circuit ID User-Define	Enter the user definition of the corresponding class.
Remote ID Format	Click the drop-down menu to set the Remote ID format: String, Hex, User Definition.
Remote ID String	Enter the remote string ID of the corresponding class.
Remote ID Hex	Enter the remote hex string of the corresponding class.
Remote ID User-Define	Enter the remote user definition of the corresponding class.
Apply	Click Apply to save the values and update the screen.

The ensuing table for **DHCP Client Option 82 Information** table settings are informational only: Status, Circuit ID Format, Circuit ID String, Circuit ID Hex, Circuit ID User-Define, Remote ID Format, Remote ID String, Remote ID Hex and Remote ID User-Define.

4.4.4 DHCP Auto Provision

The DHCP Auto Provision feature allows you to load configurations using a server with DHCP options. Through the remote connection, the switch obtains information from a configuration file available through the TFTP server.

To access this page, click **System > DHCP Auto Provision**.

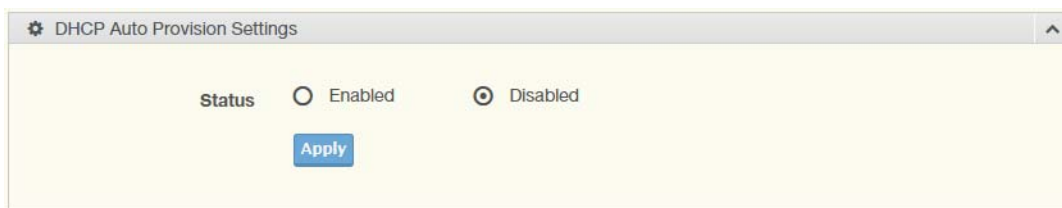

Figure 4.13 System > DHCP Auto Provision

The following table describes the items in the previous figure.

Item	Description
Status	Select the radio button to enable or disable the DHCP Auto Provisioning Setting.
Apply	Click Apply to save the values and update the screen.

The ensuing table for **DHCP Auto Provision Information** settings are informational only: Status.

4.4.5 Management VLAN

By default the VLAN is the management VLAN providing communication with the switch management interface.

To access this page, click **System > Management VLAN**.



Figure 4.14 System > Management VLAN

The following table describes the items in the previous figure.

Item	Description
Management VLAN	Click the drop-down menu to select a defined VLAN.
Apply	Click Apply to save the values and update the screen.

The ensuing table for **Management VLAN State** are informational only: Management VLAN.

4.4.6 System Time

To access this page, click **System > System Time**.

Figure 4.15 System > System Time

The following table describes the items in the previous figure.

Item	Description
Enable SNTP	Click the radio button to enable or disable the SNTP.
SNTP/NTP Server Address	Enter the address of the SNTP server. This is a text string of up to 64 characters containing the encoded unicast IP address or hostname of a SNTP server. Unicast SNTP requests will be sent to this address. If this address is a DNS hostname, then that hostname should be resolved into an IP address each time a SNTP request is sent to it.
SNTP Port	Enter the port on the server to which SNTP requests are to be sent. Allowed range is 1 to 65535 (default: 123).
Manual Time	Click the drop-down menus to set local date and time of the system.
Time Zone	Click the drop-down menu to select a system time zone.
Daylight Saving Time	Click the drop-down menu to enable or disable the daylight saving time settings.
Daylight Saving Time Offset	Enter the offsetting variable in seconds to adjust for daylight saving time.
Recurring From	Click the drop-down menu to designate the start date and time for daylight saving time.
Recurring To	Click the drop-down menu to designate the end date and time for daylight saving time.

Item	Description
Non-Recurring From	Click the drop-down menu to designate a start date and time for a non-recurring daylight saving time event.
Non-Recurring To	Click the drop-down menu to designate the end date and time for a non-recurring daylight saving time event.
Apply	Click Apply to save the values and update the screen.

The ensuing table for **System Time Information** settings are informational only: Current Date/Time, SNTP, SNTP Server Address, SNTP Server Port, Time zone, Daylight Saving Time, Daylight Saving Time Offset, From and To.

4.4.7 Network Port

To access this page, click **System > Network Port**.

The screenshot shows a web interface titled 'Network Port Settings'. It features four rows of settings, each with a label and a text input field containing a port number:

- HTTP: 80
- HTTPS: 443
- TELNET: 23
- SSH: 22

 At the bottom of the form is a blue 'Apply' button.

Figure 4.16 System > Network Port

The following table describes the items in the previous figure.

Item	Description
HTTP	By default, the HTTP port setting is set to port 80. To assign the web interface to a different port, enter the port number in the field.
HTTPS	By default, the HTTPS port setting is set to port 443. To assign the web interface to a different port, enter the port number in the field.
TELNET	By default, the TELNET port setting is set to port 23. To assign the web interface to a different port, enter the port number in the field.
SSH	By default, the SSH port setting is set to port 22. To assign the web interface to a different port, enter the port number in the field.
Apply	Click Apply to save the values and update the screen.

The ensuing table for **Network Port Information** are informational only: HTTP, HTTPS, TELNET and SSH.

4.5 L2 Switching

4.5.1 Port Configuration

Port Configuration describes how to use the user interface to configure LAN ports on the switch.

To access this page, click **L2 Switching > Port Configuration**.

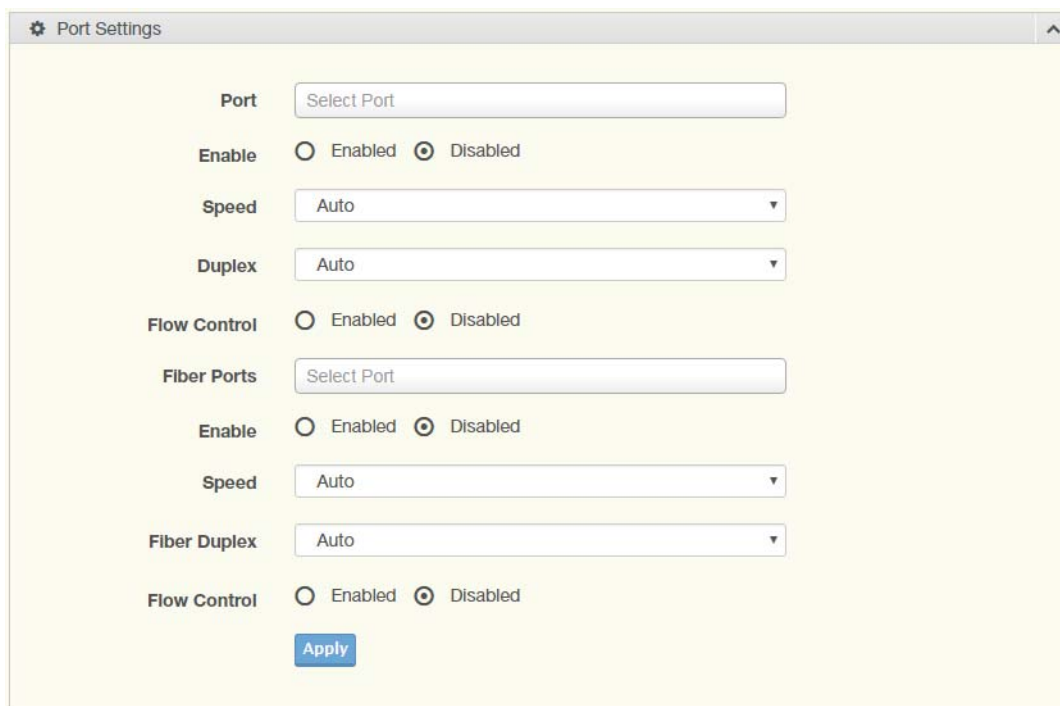

The screenshot shows a web interface for configuring ports. It is titled "Port Settings". There are two main sections: "Port" and "Fiber Ports". Each section has an "Enable" radio button (set to "Disabled"), a "Speed" dropdown menu (set to "Auto"), and a "Duplex" dropdown menu (set to "Auto"). There is also a "Flow Control" radio button (set to "Disabled") in each section. An "Apply" button is located at the bottom of the form.

Figure 4.17 L2 Switching > Port Configuration

The following table describes the items in the previous figure.

Item	Description
Port	Click the drop-down menu to select the port for the L2 Switch setting.
Enabled	Click the radio-button to enable or disable the Port Setting function.
Speed	Click the drop-down menu to select the port speed: Auto, Auto-10M, Auto-100M, Auto-1000M, Auto-10/100M, 10M, 100M, or 1000M.
Duplex	Click the drop-down menu to select the duplex setting: Auto, Half or Full.
Flow Control	Click the radio button to enable or disable the flow control function.
Fiber Port	Click the drop-down menu to select the port for the L2 Switch Fiber port setting.
Enabled	Click the radio-button to enable or disable the Fiber Port Setting function.
Speed	Click the drop-down menu to select the fiber port speed: Auto, Auto-1000M, 100M, or 1000M.
Duplex	Click the drop-down menu to select the duplex setting: Half or Full.
Flow Control	Click the radio button to enable or disable the flow control function.
Apply	Click Apply to save the values and update the screen.

The ensuing table for **Port Status** settings are informational only: Port, **Edit** (click to enter description), Enable State, Link Status, Speed, Duplex, FlowCtrl Config and FlowCtrl Status.

4.5.2 Port Mirror

Port mirroring function allows the sending of a copy of network packets seen on one switch port to a network monitoring connection on another switch port. Port mirroring can be used to analyze and debug data or diagnose errors on a network or to mirror either inbound or outbound traffic (or both).

There are no preset values in the Port Mirror. The displayed values do not represent the actual setting values.

To access this page, click **L2 Switching > Port Mirror**.

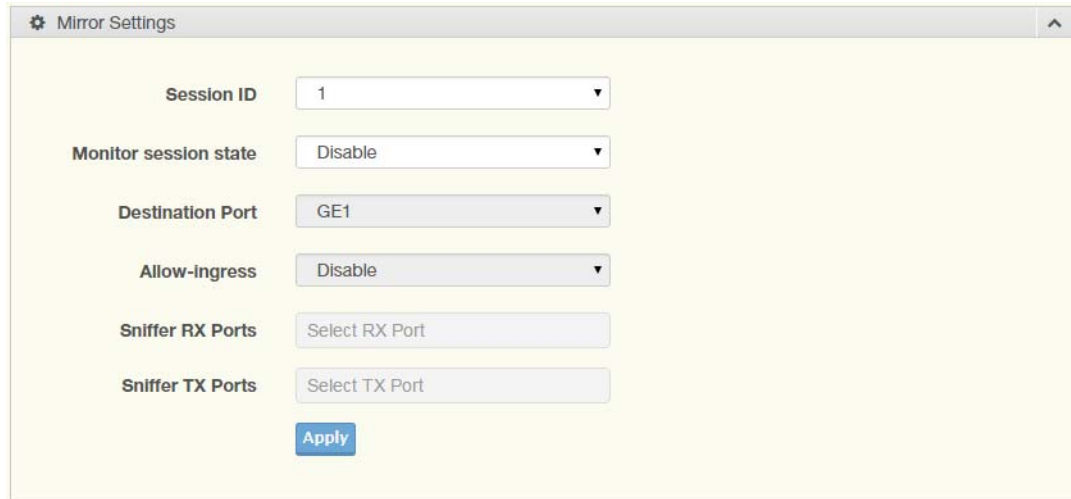

Figure 4.18 L2 Switching > Port Mirror

The following table describes the items in the previous figure.

Item	Description
Session ID	Click the drop-down menu to select a port mirroring session from the list. The number of sessions allowed is platform specific.
Monitor session state	Click the drop-down menu to enable or disable the session mode for a selected session ID.
Destination Port	Click the drop-down menu to select the destination port and receive all the traffic from configured mirrored port(s).
Allow-ingress	Click the drop-down menu to enable or disable the Allow-ingress function.
Sniffer RX Ports	Enter the variable to define the RX port.
Sniffer TX Ports	Enter the variable to define the TX port.
Apply	Click Apply to save the values and update the screen.

The ensuing table for **Mirror Status** settings are informational only: Session ID, Destination Port, Ingress State, Source TX Port and Source RX Port.

4.5.3 Link Aggregation

Link Aggregation is a method for combining multiple network connections in parallel in order to increase throughput beyond the capability of a single connection, and to provide redundancy in case one of the links should fail.

4.5.3.1 Load Balance

The Load Balancing page allows you to select between a MAC Address or IP/MAC Address algorithm for the even distribution of IP traffic across two or more links.

To access this page, click **L2 Switching > Link Aggregation > Load Balance**.



Figure 4.19 L2 Switching > Link Aggregation > Load Balance

The following table describes the items in the previous figure.

Item	Description
Load Balance Algorithm	Select the radio button to select the Load Balance Setting: MAC Address, IP/MAC Address or Source Port.
Apply	Click Apply to save the values and update the screen.

The ensuing table for **Load Balance Information** settings are informational only: Load Balance Algorithm.

4.5.3.2 LAG Management

Link aggregation is also known as trunking. It is a feature available on the Ethernet gateway and is used with Layer 2 Bridging. Link aggregation allows for the logical merging of multiple ports into a single link.

To access this page, click **L2 Switching > Link Aggregation > LAG Management**.



Figure 4.20 L2 Switching > Link Aggregation > LAG Management

The following table describes the items in the previous figure.

Item	Description
LAG	Click the drop-down menu to select the designated trunk group: Trunk 1 ~8.
Name	Enter an entry to specify the LAG name.
Type	Click the radio button to specify the type mode: Static or LACP.
Ports	Click the drop-down menu to select designated ports: FE1-8 or GE1-2.
Apply	Click Apply to save the values and update the screen.

The ensuing table for **LAG Management Information** settings are informational only: LAG, Name, Type, Link State, Active Member, Standby Member, **Edit** (click to modify the settings) and **Clear** (click to load default settings).

4.5.3.3 LAG Port Settings

The LAG Port Settings page allows you to enable or disable, set LAG status, speed and flow control functions.

In this example we will configure a LAG between the following switches:

To access this page, click **L2 Switching > Link Aggregation > LAG Port Settings**.

Figure 4.21 L2 Switching > Link Aggregation > LAG Port Settings

The following table describes the items in the previous figure.

Item	Description
LAG Select	Click the drop-down menu to select a predefined LAG trunk definition: LAG 1-8.
Enabled	Click the radio button to enable or disable the LAG Port.
Speed	Click the drop-down menu to select the port speed: Auto, Auto-10M, Auto-100M, Auto-1000M, Auto-10/100M, 10M, 100M, or 1000M.
Flow Control	Click the radio button to enable or disable the Flow Control for the LAG Port.
Apply	Click Apply to save the values and update the screen.

The ensuing table for **LAG Port Status** settings are informational only: LAG, Description, Port Type, Enable State, Link Status, Speed, Duplex, FlowCtrl Config and FlowCtrl Status.

4.5.3.4 LACP Priority Settings

The LACP Priority Settings page allows you to configure the system priority for LACP.

To access this page, click **L2 Switching > Link Aggregation > LACP Priority Settings**.

Figure 4.22 L2 Switching > Link Aggregation > LACP Priority Settings

The following table describes the items in the previous figure.

Item	Description
System Priority	Enter the value (1-65535) to designate the LACP system priority.
Apply	Click Apply to save the values and update the screen.

The ensuing table for **LACP Information** settings are informational only: System Priority.

4.5.3.5 LACP Port Settings

Link Aggregation Control Protocol (LACP) provides a method to control the bundling of several physical ports together to form a single logical channel. By configuring the LACP function, the switch can negotiate an automatic bundling of links by sending LACP packets to the peer device (also implementing LACP).

To access this page, click **L2 Switching > Link Aggregation > LACP Port Settings**.

Figure 4.23 L2 Switching > Link Aggregation > LACP Port Settings

The following table describes the items in the previous figure.

Item	Description
Port Select	Select a port for the LACP Port Settings. The listed available settings are: FE1-FE8, GE1-GE2. However, the available settings are dependent on the connected LACP device and may not be listed as displayed in the current figure.
Priority	Enter a variable (1 to 65535) to assign a priority to the defined port selection.
Timeout	Click the radio button to select a long or short timeout period.
Mode	Click the radio button to select the setting mode: Active or Passive. <ul style="list-style-type: none"> ■ Active: Enables LACP unconditionally. ■ Passive: Enables LACP only when an LACP device is detected (default state).
Apply	Click Apply to save the values and update the screen.

The ensuing table for **LACP Port Information** settings are informational only: Port Name, Priority, Timeout and Mode.

4.5.4 802.1Q VLAN

The 802.1Q VLAN feature allows for a single VLAN to support multiple VLANs. With the 802.1Q feature you can preserve VLAN IDs and segregate different VLAN traffic. The 802.1Q VLAN tag feature encapsulates the 802.1Q VLAN tagging within another 802.1Q VLAN tag. The outer tag is assigned following the AP group, while the inner VLAN ID is assigned dynamically by the AAA server.

4.5.4.1 VLAN Management

The management of VLANs is available through the VLAN Settings page. Through this page you can add or delete VLAN listings and add a prefix name to an added entry.

To access this page, click **L2 Switching > 802.1Q VLAN > VLAN Management**.

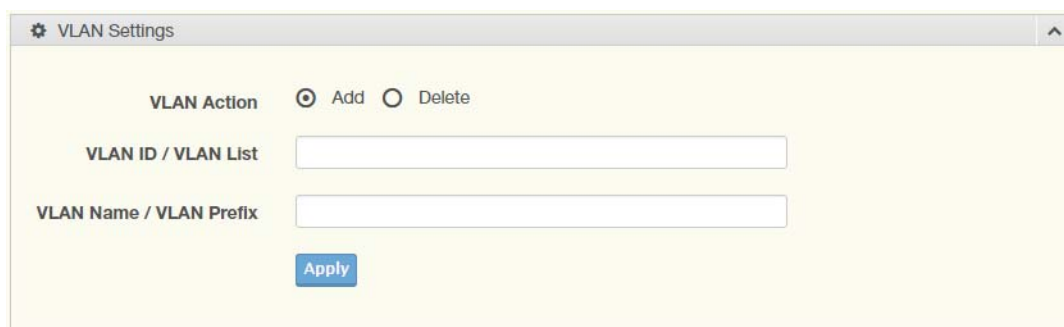

Figure 4.24 L2 Switching > 802.1Q VLAN > VLAN Management

The following table describes the items in the previous figure.

Item	Description
VLAN Action	Click the radio button to add or delete the VLAN entry shown in the previous field.
VLAN ID / VLAN List	Enter the name of the VLAN entry to setup.
VLAN Name / VLAN Prefix	Enter the prefix to be used by the VLAN list entry in the previous field.
Apply	Click Apply to save the values and update the screen.

The ensuing table for **VLAN Table** settings are informational only: VLAN ID, VLAN Name, VLAN Type and **Edit** (click to enter VLAN name).

4.5.4.2 PVID Settings

The PVID Settings page allows you to designate a PVID for a selected port, define the accepted type and enable/disable the ingress filtering.

To access this page, click **L2 Switching > 802.1Q VLAN > PVID Settings**.

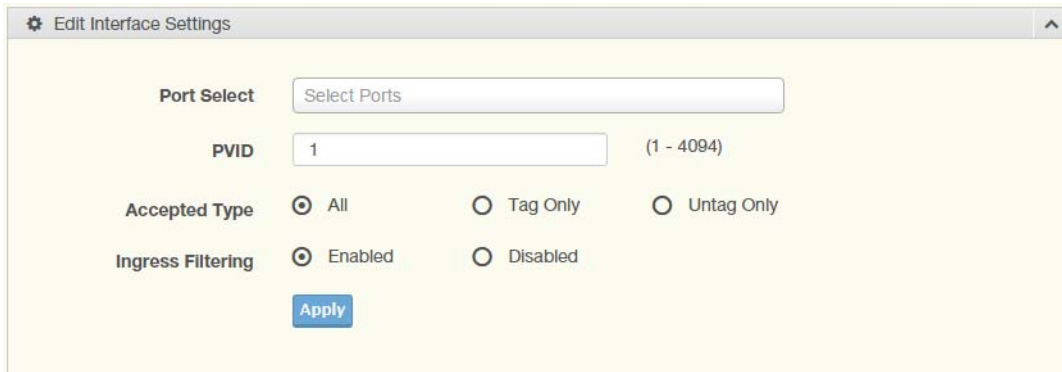

Figure 4.25 L2 Switching > 802.1Q VLAN > PVID Settings

The following table describes the items in the previous figure.

Item	Description
Port Select	Click the drop-down menu to select a port and edit its settings: FE1-FE8, GE1-GE2, or Trunk1 - Trunk8.
PVID	Enter the VLAN ID you want assigned to untagged or priority tagged frames received on this port. The value ranges 1 to 4094. The default is 1.
Accepted Type	Click the radio button to specify which frames to forward. Tag Only discards any untagged or priority tagged frames. Untag Only discards any tagged frames. All accepts all untagged and tagged frames. Whichever you select, VLAN tagged frames are forwarded in accordance with the IEEE 802.1Q VLAN standard. The default is All.
Ingress Filtering	Click the radio button to specify how you want the port to handle tagged frames. If you enable Ingress Filtering, a tagged frame will be discarded if this port is not a member of the VLAN identified by the VLAN ID in the tag. If you select Disabled, all tagged frames will be accepted. The default is Disabled.
Apply	Click Apply to save the values and update the screen.

The ensuing table for **Port VLAN Status** settings are informational only: Port, Interface VLAN Mode, PVID, Accept Frame Type and Ingress Filtering.

4.5.4.3 Port to VLAN

The Port to VLAN page allows you to add a port to a VLAN and select the related parameters.

To access this page, click **L2 Switching > 802.1Q VLAN > Port to VLAN**.

VLAN ID :

Port to VLAN Table			
Port	Interface VLAN Mode	Membership	PVID
GE1	Hybrid	<input type="radio"/> Forbidden <input type="radio"/> Excluded <input type="radio"/> Tagged <input checked="" type="radio"/> Untagged	YES
GE2	Hybrid	<input type="radio"/> Forbidden <input type="radio"/> Excluded <input type="radio"/> Tagged <input checked="" type="radio"/> Untagged	YES
GE3	Hybrid	<input type="radio"/> Forbidden <input type="radio"/> Excluded <input type="radio"/> Tagged <input checked="" type="radio"/> Untagged	YES
GE4	Hybrid	<input type="radio"/> Forbidden <input type="radio"/> Excluded <input type="radio"/> Tagged <input checked="" type="radio"/> Untagged	YES
GE5	Hybrid	<input type="radio"/> Forbidden <input type="radio"/> Excluded <input type="radio"/> Tagged <input checked="" type="radio"/> Untagged	YES
GE6	Hybrid	<input type="radio"/> Forbidden <input type="radio"/> Excluded <input type="radio"/> Tagged <input checked="" type="radio"/> Untagged	YES
GE7	Hybrid	<input type="radio"/> Forbidden <input type="radio"/> Excluded <input type="radio"/> Tagged <input checked="" type="radio"/> Untagged	YES
GE8	Hybrid	<input type="radio"/> Forbidden <input type="radio"/> Excluded <input type="radio"/> Tagged <input checked="" type="radio"/> Untagged	YES
GE9	Hybrid	<input type="radio"/> Forbidden <input type="radio"/> Excluded <input type="radio"/> Tagged <input checked="" type="radio"/> Untagged	YES
GE10	Hybrid	<input type="radio"/> Forbidden <input type="radio"/> Excluded <input type="radio"/> Tagged <input checked="" type="radio"/> Untagged	YES
Trunk1	Hybrid	<input type="radio"/> Forbidden <input type="radio"/> Excluded <input type="radio"/> Tagged <input checked="" type="radio"/> Untagged	YES
Trunk2	Hybrid	<input type="radio"/> Forbidden <input type="radio"/> Excluded <input type="radio"/> Tagged <input checked="" type="radio"/> Untagged	YES
Trunk3	Hybrid	<input type="radio"/> Forbidden <input type="radio"/> Excluded <input type="radio"/> Tagged <input checked="" type="radio"/> Untagged	YES
Trunk4	Hybrid	<input type="radio"/> Forbidden <input type="radio"/> Excluded <input type="radio"/> Tagged <input checked="" type="radio"/> Untagged	YES
Trunk5	Hybrid	<input type="radio"/> Forbidden <input type="radio"/> Excluded <input type="radio"/> Tagged <input checked="" type="radio"/> Untagged	YES
Trunk6	Hybrid	<input type="radio"/> Forbidden <input type="radio"/> Excluded <input type="radio"/> Tagged <input checked="" type="radio"/> Untagged	YES
Trunk7	Hybrid	<input type="radio"/> Forbidden <input type="radio"/> Excluded <input type="radio"/> Tagged <input checked="" type="radio"/> Untagged	YES
Trunk8	Hybrid	<input type="radio"/> Forbidden <input type="radio"/> Excluded <input type="radio"/> Tagged <input checked="" type="radio"/> Untagged	YES

Figure 4.26 L2 Switching > 802.1Q VLAN > Port to VLAN

The following table describes the items in the previous figure.

Item	Description
Port	Displays the assigned port to the entry.
Interface VLAN Mode	Displays the assigned mode to the listed VLAN port. <ul style="list-style-type: none"> ■ Hybrid: Port hybrid model. ■ Access: Port hybrid model. ■ Trunk: Port hybrid model. ■ Tunnel: Port hybrid model.
Membership	Displays the assigned membership status of the port entry, options include: Forbidden, Excluded Tagged or Untagged.
Apply	Click Apply to save the values and update the screen.

4.5.4.4 Port-VLAN Mapping

To access this page, click **L2 Switching > 802.1Q VLAN > Port-VLAN Mapping**.

The ensuing table for **Port-VLAN Mapping Table** settings are informational only: Port, Mode, Administrative VLANs and Operational VLANs.

4.5.5 Q-in-Q

Q-in-Q is commonly referred as VLAN stacking in which VLANs are nested by adding two tags to each frame instead of one. Network service provider and users both can use VLANs and makes it possible to have more than the 4094 separate VLANs allowed by 802.1Q.

There are three ways in which a machine can be connected to a network carrying double-tagged 802.1ad traffic:

- via a untagged port, where both inner and outer VLANs are handled by the switch or switches (so the attached machine sees ordinary Ethernet frames);
- via a single-tagged (tunnel) port, where the outer VLAN only is handled by the switch (so the attached machine sees single-tagged 802.1Q VLAN frames); or
- via a double-tagged (trunk) port, where both inner and outer VLANs are handled by the attached machine (which sees double-tagged 802.1ad VLAN frames).

4.5.5.1 Global Settings

The Global Settings page allows you to set the outer VLAN Ethertype setting.

To access this page, click **L2 Switching > Q-in-Q > Global Settings**.



The screenshot shows a web interface titled "Global Settings". It features a label "Outer VLAN Ethertype" followed by a text input field containing the placeholder text "Input ethertype". To the right of the input field is the text "(0x0000-0xFFFF)". Below the input field is a blue "Apply" button.

Figure 4.27 L2 Switching > Q-in-Q > Global Settings

The following table describes the items in the previous figure.

Item	Description
Outer VLAN Ether-type	Enter the outer VLAN handled by the switch giving the attached machine a single-tagged 802.1Q VLAN frame.
Apply	Click Apply to save the values and update the screen.

The ensuing table for **QinQ Global Information** settings are informational only: Outer VLAN Ethertype.

4.5.5.2 Port Settings

The Port Settings page allows you to define the outer PVID and outer mode for a selected port.

To access this page, click **L2 Switching > Q-in-Q > Port Settings**.

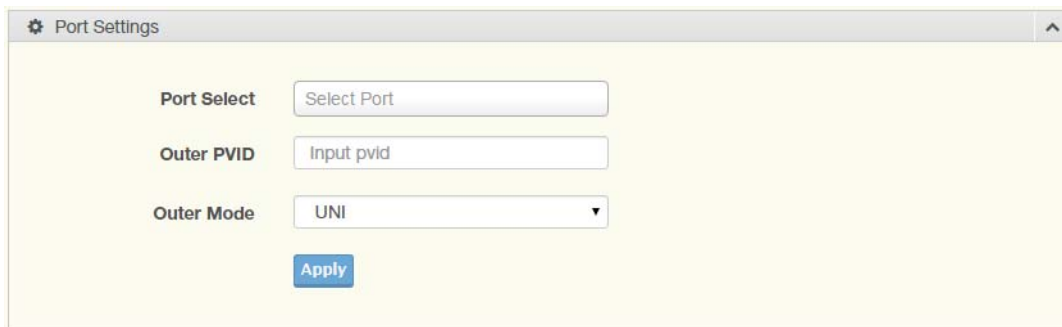

Figure 4.28 L2 Switching > Q-in-Q > Port Settings

The following table describes the items in the previous figure.

Item	Description
Port Select	Enter the switch port (part of VLAN configuration) to configure the selection as a tunnel port.
Outer PVID	Enter the Port VLAN ID (PVID) to assigned the native VLAN ID. All untagged traffic coming in or out of the 802.1Q port is forwarded based on the PVID value
Outer Mode	Click the drop-down menu to select between UNI or NNI role. <ul style="list-style-type: none">■ UNI: Selects a user-network interface which specifies communication between the specified user and a specified network.■ NNI: Selects a network-to-network interface which specifies communication between two specified networks.
Apply	Click Apply to save the values and update the screen.

The ensuing table for **QinQ Port Information** settings are informational only: Port, Outer PVID and Outer Mode.

4.5.6 GARP

The Generic Attribute Registration Protocol (GARP) is a local area network (LAN) protocol. The protocol defines procedures for the registration and de-registration of attributes (network identifiers or addresses) by end stations and switches with each other.

4.5.6.1 GARP Settings

To access this page, click **L2 Switching > GARP > GARP Settings**.

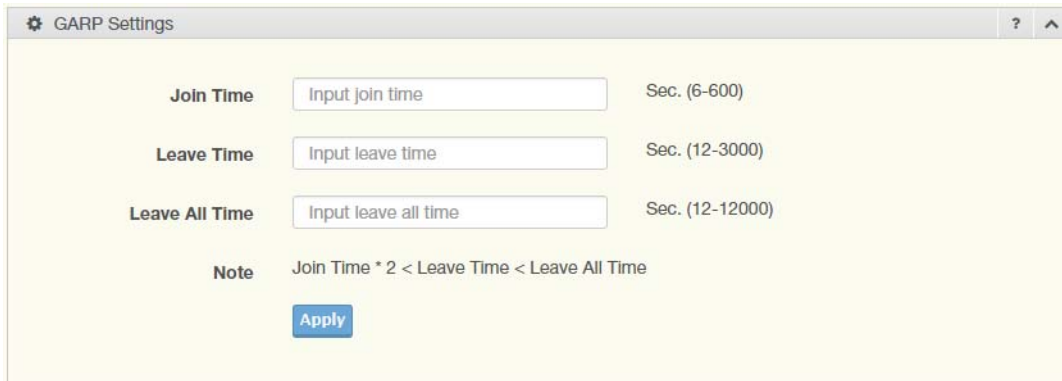

Figure 4.29 L2 Switching > GARP > GARP Settings

The following table describes the items in the previous figure.

Item	Description
Join Time	Enter a value to specify the time between the transmission of GARP PDUs registering (or re-registering) membership for a VLAN or multi-cast group in centiseconds. Enter a number between 6 and 600. An instance of this timer exists for each GARP participant for each port.
Leave Time	Enter a value to specify the time to wait after receiving an unregister request for a VLAN or multicast group before deleting the associated entry, in centiseconds. This allows time for another station to assert registration for the same attribute in order to maintain uninterrupted service. Enter a number between 12 and 3000. An instance of this timer exists for each GARP participant for each port.
Leave All Time	Enter a value to specify the Leave All Time controls how frequently Leave All PDUs are generated. A LeaveAll PDU indicates that all registrations will shortly be deregistered. Participants will need to rejoin in order to maintain registration. The Leave All Period Timer is set to a random value in the range of LeaveAllTime to 1.5*LeaveAllTime. The timer is specified in centiseconds. Enter a number between 12 and 12000. An instance of this timer exists for each GARP participant for each port.
Apply	Click Apply to save the values and update the screen.

The ensuing table for **GARP Information** settings are informational only: Join Time, Leave Time and Leave All Time.

4.5.6.2 GVRP Settings

The GVRP Settings page allows you to enable or disable the GVRP (GARP VLAN Registration Protocol or Generic VLAN Registration Protocol) protocol which facilitates control of virtual local area networks (VLANs) within a larger network.

To access this page, click **L2 Switching > GARP > GVRP Settings**.



Figure 4.30 L2 Switching > GARP > GVRP Settings

The following table describes the items in the previous figure.

Item	Description
Status	Click to enable or disable the GARP VLAN Registration Protocol administrative mode for the switch. The factory default is Disable.
Apply	Click Apply to save the values and update the screen.

The ensuing table for **GVRP Information** settings are informational only: GVRP.

4.5.6.3 GMRP Settings

To access this page, click **L2 Switching > GARP > GMRP Settings**.

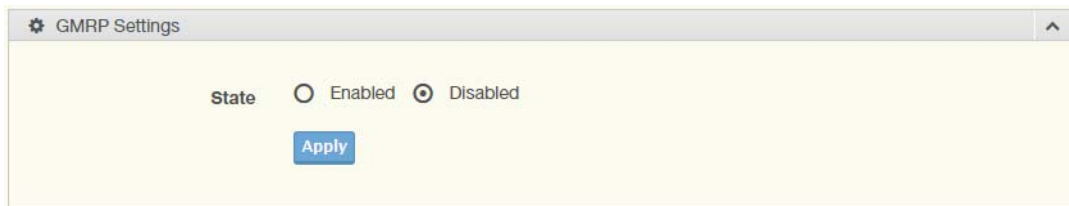

Figure 4.31 L2 Switching > GARP > GMRP Settings

The following table describes the items in the previous figure.

Item	Description
State	Click to enable or disable the GMRP mode for the switch. The factory default is Disable.
Apply	Click Apply to save the values and update the screen.

The ensuing table for **GMRP Information** settings are informational only: GMRP.

The ensuing table for **Multicast Groups** settings are informational only: VLAN ID, MAC Address, Type and Member Ports.

4.5.7 802.3az EEE

The 802.3az Energy Efficient Ethernet (EEE) innovative green feature reduces energy consumption through intelligent functionality:

- Traffic detection — Energy Efficient Ethernet (EEE) compliance
- Inactive link detection

Inactive link detection function automatically reduces power usage when inactive links or devices are detected.

To access this page, click **L2 Switching > 802.3az EEE**.



Figure 4.32 L2 Switching > 802.3az EEE

The following table describes the items in the previous figure.

Item	Description
Port Select	Enter the port to setup the EEE function.
State	Click Enabled or Disabled to set the state mode of the port select setting.
Apply	Click Apply to save the values and update the screen.

The ensuing table for **EEE Enable Status** settings are informational only: Port and EEE State.

4.5.8 Multicast

Multicast forwarding allows a single packet to be forwarded to multiple destinations. The service is based on L2 switch receiving a single packet addressed to a specific Multicast address. Multicast forwarding creates copies of the packet, and transmits the packets to the relevant ports.

4.5.8.1 Multicast Filtering

The Multicast Filtering page allows for the definition of action settings when an unknown multicast request is received. The options include: Drop, Flood, or Router Port.

To access this page, click **L2 Switching > Multicast > Multicast Filtering**.



Figure 4.33 L2 Switching > Multicast > Multicast Filtering

The following table describes the items in the previous figure.

Item	Description
Unknown Multicast Action	Select the configuration protocol: Drop, Flood, or Router Port, to apply for any unknown multicast event.
Apply	Click Apply to save the values and update the screen.

The ensuing table for **Properties Information** settings are informational only: Unknown Multicast Action.

4.5.8.2 IGMP Snooping

IGMP Snooping is defined as the process of listening to Internet Group Management Protocol (IGMP) network traffic. IGMP Snooping allows a network switch to listen in on the IGMP conversation between hosts and routers and maintain a map of which links need which IP multicast streams. Multicasts can be filtered from the links which do not need them in turn controlling which ports receive specific multicast traffic.

IGMP Settings

To access this page, click **L2 Switching > Multicast > IGMP Snooping > IGMP Settings**.



Figure 4.34 L2 Switching > Multicast > IGMP Snooping > IGMP Settings

The following table describes the items in the previous figure.

Item	Description
IGMP Snooping State	Select Enable or Disable to designate the IGMP Snooping State.
IGMP Snooping Version	Select designate the IGMP Snooping Version: V2 or V3.
IGMP Snooping Report Suppression	Select Enable or Disable to setup the report suppression for IGMP Snooping.
Apply	Click Apply to save the values and update the screen.

The ensuing table for **IGMP Snooping Information** settings are informational only: IGMP Snooping State, IGMP Snooping Version and IGMP Snooping V2 Report Suppression.

The ensuing table for **IGMP Snooping Table** settings are informational only: Entry No., VLAN ID, IGMP Snooping Operation State, Router Ports Auto Learn, Query Robustness, Query Interval (sec.), Query Max Response Interval (sec.), Last Member Query count, Last Member Query Interval (sec), Immediate Leave and **Edit** (click to modify the settings).

IGMP Querier

IGMP Querier allows snooping to function by creating the tables for snooping. General queries must be unconditionally forwarded by all switches involved in IGMP snooping.

To access this page, click **L2 Switching > Multicast > IGMP Snooping > IGMP Querier**.

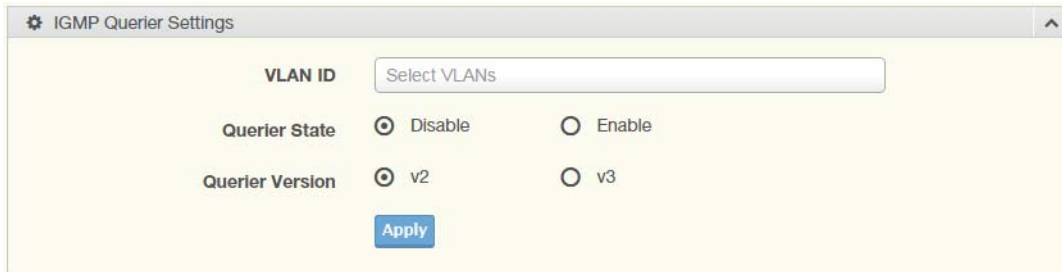

Figure 4.35 L2 Switching > Multicast > IGMP Snooping > IGMP Querier

The following table describes the items in the previous figure.

Item	Description
VLAN ID	Select the VLAN ID to define the local IGMP querier.
Querier State	Select Disable or Enable to configure the VLAN ID (IGMP Querier).
Querier Version	Select the querier version (V2 or V3) designated to the selected VLAN ID.
Apply	Click Apply to save the values and update the screen.

The ensuing table for **IGMP Querier Status** settings are informational only: VLAN ID, Querier State, Querier Status, Querier Version and Querier IP.

IGMP Static Groups

To access this page, click **L2 Switching > Multicast > IGMP Snooping > IGMP Static Groups**.

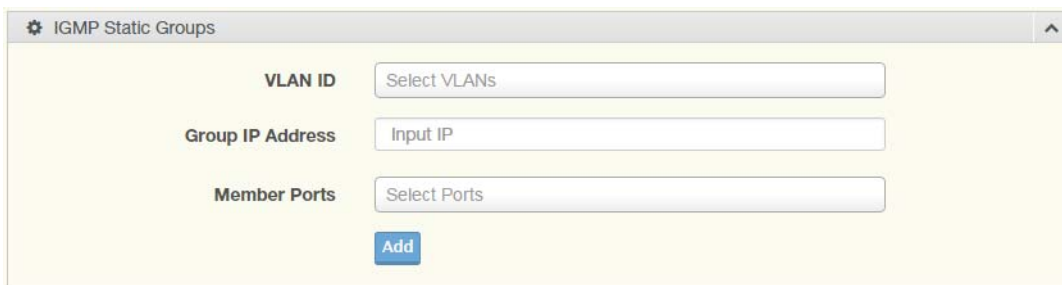

Figure 4.36 L2 Switching > Multicast > IGMP Snooping > IGMP Static Groups

The following table describes the items in the previous figure.

Item	Description
VLAN ID	Select the VLAN ID to define IGMP static group.
Group IP Address	Enter the IP address assigned to the VLAN ID.
Member Ports	Enter the port numbers to associate with the static group.
Add	Click Add to add an IGMP group.

The ensuing table for **IGMP Static Groups Status** settings are informational only: VLAN ID, Group IP Address, Member Ports and Modify.

Multicast Groups

To access this page, click **L2 Switching > Multicast > IGMP Snooping > Multicast Groups**.

The ensuing table for **Multicast Groups** settings are informational only: VLAN ID, Group IP Address, Member Ports, Type and Life (Sec).

Router Ports

To access this page, click **L2 Switching > Multicast > IGMP Snooping > Router Ports**.

The ensuing table for **Router Ports** settings are informational only: VLAN ID, Port and Expiry Time (Sec).

4.5.8.3 MLD Snooping

The MLD Snooping page allows you to select the snooping status (enable or disable), the version (v1 or v2) and the enabling/disabling of the report suppression for the MLD querier, which sends out periodic general MLD queries and are forwarded through all ports in the VLAN.

MLD Settings

To access this page, click **L2 Switching > Multicast > MLD Snooping > MLD Settings**.



Figure 4.37 L2 Switching > Multicast > MLD Snooping > MLD Settings

The following table describes the items in the previous figure.

Item	Description
MLD Snooping State	Select Enable or Disable to setup the MLD Snooping State.
MLD Snooping Version	Select the querier version (V1 or V2) designated to the MLD Snooping Version.
MLD Snooping Report Suppression	Select Enable or Disable to designate the status of the report suppression.
Apply	Click Apply to save the values and update the screen.

The ensuing table for **MLD Snooping Information** settings are informational only: MLD Snooping State, MLD Snooping Version and MLD Snooping V2 Report Suppression.

The ensuing table for **MLD Snooping Table** settings are informational only: Entry No., VLAN ID, MLD Snooping Operation State, Router Ports Auto Learn, Query Robustness, Query Interval (sec.), Query Max Response Interval (sec.), Last Member Query count, Last Member Query Interval (sec), Immediate Leave and **Edit** (click to modify the settings).

MLD Querier

The MLD Querier page allows you to select and enable/disable the MLD querier and define the version (IGMPv1 or IGMPv2) when enabled.

To access this page, click **L2 Switching > Multicast > MLD Snooping > MLD Querier**.

Figure 4.38 L2 Switching > Multicast > MLD Snooping > MLD Querier

The following table describes the items in the previous figure.

Item	Description
VLAN ID	Enter the VLAN ID to configure.
Querier State	Select Enable or Disable status on the selected VLAN. <input type="checkbox"/> Enable: Enable IGMP Querier Election. <input checked="" type="checkbox"/> Disable: Disable IGMP Querier Election.
Querier Version	Select the querier version (IGMPV1 or IGMPV2) designated to the MLD Querier function.
Apply	Click Apply to save the values and update the screen.

The ensuing table for **MLD Querier Status** settings are informational only: VLAN ID, Querier State, Querier Status, Querier Version and Querier IP.

MLD Static Group

The MLD Static Group page allows you to configure specified ports as static member ports.

To access this page, click **L2 Switching > Multicast > MLD Snooping > MLD Static Group**.

Figure 4.39 L2 Switching > Multicast > MLD Snooping > MLD Static Group

The following table describes the items in the previous figure.

Item	Description
VLAN ID	Enter the VLAN ID to define the local MLD Static Group.
Group IP Address	Enter the IP address associated with the static group.
Member Ports	Enter the ports designated with the static group.
Add	Click Add to add a MLD static group.

The ensuing table for **MLD Static Groups Status** settings are informational only: VLAN ID, Group IP Address, Member Ports and Modify.

Multicast Groups

To access this page, click **L2 Switching > Multicast > MLD Snooping > Multicast Groups**.

The ensuing table for **Multicast Groups** settings are informational only: ID, Group IP Address, Member Ports, Type and Life (Sec).

Router Ports

To access this page, click **L2 Switching > Multicast > MLD Snooping > Router Ports**.

The ensuing table for **Router Ports** settings are informational only: VLAN ID, Port and Expiry Time (Sec).

4.5.9 Jumbo Frame

Jumbo frames are frames larger than the standard Ethernet frame size of 1518 bytes. The Jumbo Frame function allows the configuration of Ethernet frame size.

To access this page, click **L2 Switching > Jumbo Frame**.



Figure 4.40 L2 Switching > Jumbo Frame

The following table describes the items in the previous figure.

Item	Description
Jumbo Frame (Bytes)	Enter the variable in bytes (1518 to 9216) to define the jumbo frame size.
Apply	Click Apply to save the values and update the screen.

The ensuing table for **Jumbo Frame Config** settings are informational only: Jumbo Frame (Bytes).

4.5.10 Spanning Tree

The Spanning Tree Protocol (STP) is a network protocol to ensure loop-free topology for any bridged Ethernet local area network.

4.5.10.1 STP Global Settings

The STP Global Settings page allows you to set the STP status, select the configuration for a BPDU packet, choose the path overhead, force version and set the configuration revision range.

To access this page, click **L2 Switching > Spanning Tree > STP Global Settings**.

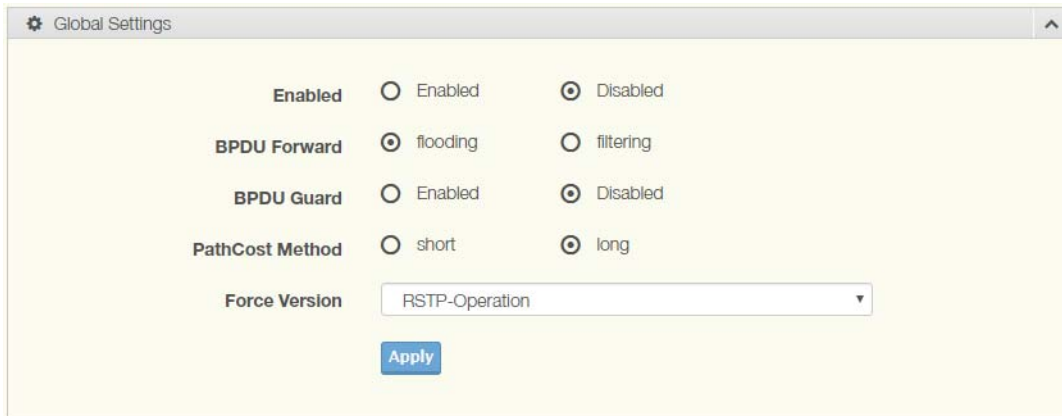

Figure 4.41 L2 Switching > Spanning Tree > STP Global Settings

The following table describes the items in the previous figure.

Item	Description
Enabled	Click the radio-button to enable or disable the STP status.
BPDU Forward	Select flooding or filtering to designate the type of BPDU packet.
BPDU Guard	Click the radio-button to enable or disable the BPDU guard. When enabled, BPDU Guard can disable edge ports that receive BPDU packets. This prevents a new device from entering the existing STP topology. Thus devices that were originally not a part of STP are not allowed to influence the STP topology
PathCost Method	Select short or long to define the method of used for path cost calculations.
Force Version	Click the drop-down menu to select the operating mode for STP. <ul style="list-style-type: none">■ STP-Compatible: 802.1D STP operation.■ RSTP-Operation: 802.1w operation.■ MSTP-Operation: 802.1s operation.
Apply	Click Apply to save the values and update the screen.

The ensuing table for **STP Information** settings are informational only: STP, BPDU Forward, BPDU Guard, PathCost Method and Force Version.

4.5.10.2 STP Port Settings

The STP Port Settings page allows you to configure the ports for the setting, port's contribution, configure edge port, and set the status of the BPDU filter.

To access this page, click **L2 Switching > Spanning Tree > STP Port Settings**.

Figure 4.42 L2 Switching > Spanning Tree > STP Port Settings

The following table describes the items in the previous figure.

Item	Description
Port Select	Select the port list to specify the ports that apply to this setting.
Admin Enable	Select Enabled or Disabled to setup the admin profile for the STP port.
Path Cost (0 = Auto)	Set the port's cost contribution. For a root port, the root path cost for the bridge. (0 means Auto).
Edge Port	Click the drop-down menu to set the edge port configuration. <ul style="list-style-type: none"> ■ No: Force to false state (as link to a bridge). ■ Yes: Force to true state (as link to a host).
P2P MAC	Click the drop-down menu to set the Point-to-Point port configuration. <ul style="list-style-type: none"> ■ No: Force to false state. ■ Yes: Force to true state.
Migrate	Click the check box to enable the migrate function. Forces the port to use the new MST/RST BPDUs, requiring the switch to test on the LAN segment. for the presence of legacy devices, which are not able to understand the new BPDU formats.
Apply	Click Apply to save the values and update the screen.

The ensuing table for **STP Port Status** settings are informational only: Port, Admin Enable, Path Cost, Edge Port and P2P MAC.

4.5.10.3 STP Bridge Settings

The STP Bridge Settings page allows you to configure the priority, forward delay, maximum age, Tx hold count, and the hello time for the bridge.

To access this page, click **L2 Switching > Spanning Tree > STP Bridge Settings**.

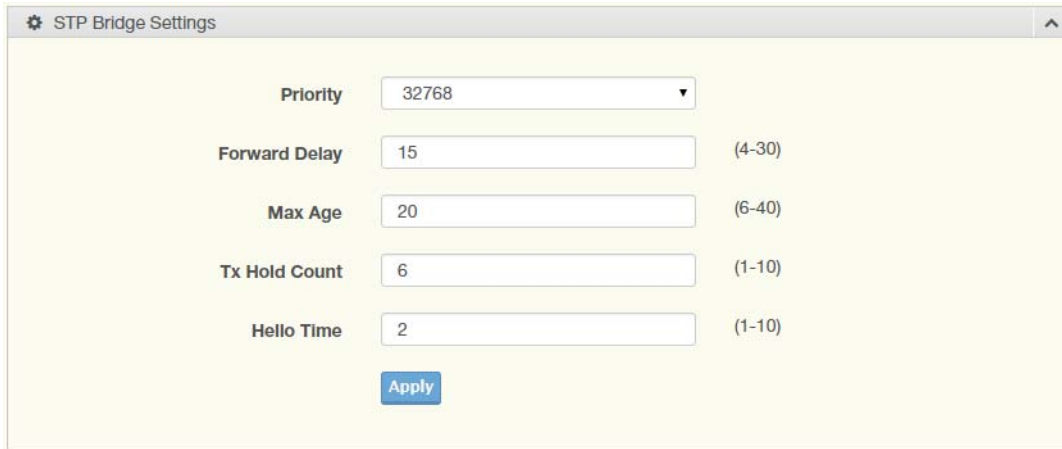

Figure 4.43 L2 Switching > Spanning Tree > STP Bridge Settings

The following table describes the items in the previous figure.

Item	Description
Priority	Click the drop-down menu to select the STP bridge priority.
Forward Delay	Enter the variable (4 to 30) to set the forward delay for STP bridge settings.
Max Age	Enter the variable (6 to 40) to set the Max age for STP bridge settings.
Tx Hold Count	Enter the variable (1 to 10) to designate the TX hold count for STP bridge settings.
Hello Time	Enter the variable (1 to 10) to designate the Hello Time for STP bridge settings.
Apply	Click Apply to save the values and update the screen.

The ensuing table for **STP Bridge Information** settings are informational only: Priority, Forward Delay, Max Age, Tx Hold Count and Hello Time.

The ensuing table for **STP Bridge Status** settings are informational only: Bridge Identifier, Designated Root Bridge, Root Path Cost, Designated Bridge, Root Port and Last Topology Change.

4.5.10.4 STP Port Advanced Settings

The STP Port Advanced Settings page allows you to select the port list to apply this setting.

To access this page, click **L2 Switching > Spanning Tree > STP Port Advanced Settings**.



Figure 4.44 L2 Switching > Spanning Tree > STP Port Advanced Settings

The following table describes the items in the previous figure.

Item	Description
Port Select	Select the port to designate the STP settings.
Priority	Click the drop-down menu to designate a priority.
Apply	Click Apply to save the values and update the screen.

The ensuing table for **STP Port Status** settings are informational only: Port, Identifier (Priority / Port Id), Path Cost Conf/Oper, Designated Root Bridge, Root Path Cost, Designated Bridge, Edge Port Conf/Oper, P2P MAC Conf/Oper, Port Role and Port State.

4.5.10.5 MST Config Identification

The MST Config Identification page allows you to configure the identification setting name and the identification range.

To access this page, click **L2 Switching > Spanning Tree > MST Config Identification**.

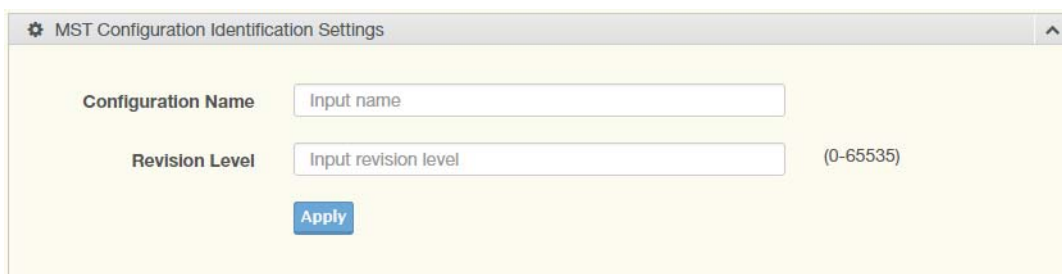

Figure 4.45 L2 Switching > Spanning Tree > MST Config Identification

The following table describes the items in the previous figure.

Item	Description
Configuration Name	Enter the identifier used to identify the configuration currently being used. It may be up to 32 characters.
Revision Level	Enter the identifier for the Revision Configuration, range: 0 to 65535 (default: 0).
Apply	Click Apply to save the values and update the screen.

The ensuing table for **MST Configuration Identification Information** settings are informational only: Configuration Name and Revision Level.

4.5.10.6 MST Instance ID Settings

The MST Instance ID Settings page allows you to edit the MSTI ID and VID List settings.

To access this page, click **L2 Switching > Spanning Tree > MST Instance ID Settings**.



Figure 4.46 L2 Switching > Spanning Tree > MST Instance ID Settings

The following table describes the items in the previous figure.

Item	Description
MSTI ID	Enter the MST instance ID (0-15).
VID List	Enter the pre-configured VID list.
Move	Click Move to save the values and update the screen.

The ensuing table for **MST Instance ID Information** settings are informational only: MSTI ID and VID List.

4.5.10.7 MST Instance Priority Settings

The MST Instance Priority Settings allows you to specify the MST instance and the bridge priority in that instance.

To access this page, click **L2 Switching > Spanning Tree > MST Instance Priority Settings**.

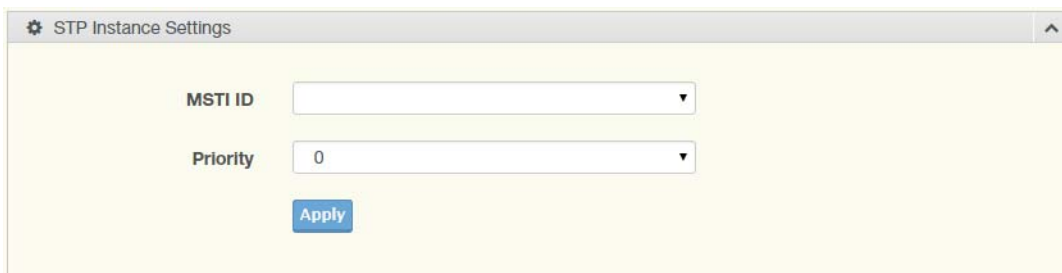

Figure 4.47 L2 Switching > Spanning Tree > MST Instance Priority Settings

The following table describes the items in the previous figure.

Item	Description
MSTI ID	Click the drop-down menu to specify the MST instance.
Priority	Click the drop-down menu set the bridge priority in the specified MST instance
Apply	Click Apply to save the values and update the screen.

The ensuing table for **MST Instance Priority Information** settings are informational only: MSTI ID, Priority and Action.

4.5.10.8 MST Instance Info

To access this page, click **L2 Switching > Spanning Tree > MST Instance Info**.

The ensuing table for **STP Bridge Status** settings are informational only: Bridge Identifier, Designated Root Bridge, Root Path Cost, Designated Bridge, Root Port and TCNLast Topology Change.

The ensuing table for **STP Port Status** settings are informational only: Port, Identifier (Priority / Port Id), Path Cost Conf/Oper, Designated Root Bridge, Root Path Cost, Designated Bridge, Edge Port Conf/Oper, P2P MAC Conf/Oper, Port Role and Port State.

4.5.10.9 STP Statistics

To access this page, click **L2 Switching > Spanning Tree > STP Statistics**.

The ensuing table for **STP Statistics** settings are informational only: Port, Configuration BPDUs Received, TCN BPDUs Received, Configuration BPDUs Transmitted and TCN BPDUs Transmitted.

4.5.11 X-Ring Elite

The X-Ring Elite function provides an improvement over Spanning Tree and Rapid Spanning Tree and a rapid auto recovery in the event that the network suffers a corrupt or broken link and prevents network loops.

4.5.11.1 X-Ring Elite Settings

The X-Ring Elite Settings allows you to enable or disable the state of the X-Ring settings.

To access this page, click **L2 Switching > X-Ring Elite > X-Ring Elite Settings**.

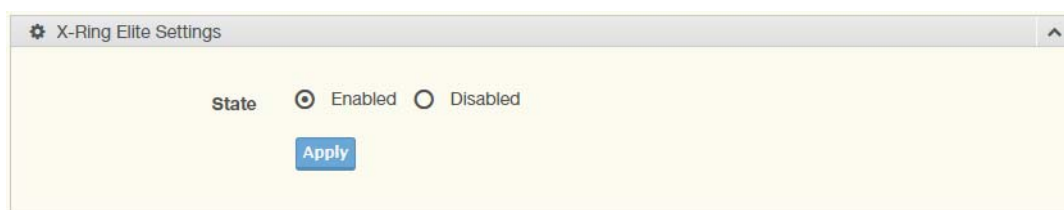

Figure 4.48 L2 Switching > X-Ring Elite > X-Ring Elite Settings

The following table describes the items in the previous figure.

Item	Description
State	Select Enabled or Disabled to setup the X-Ring Elite mode.
Apply	Click Apply to save the values and update the screen.

The ensuing table for **Information** settings are informational only: X-Ring Elite State.

4.5.11.2 X-Ring Elite Groups

The X-Ring Elite Groups page allows you to select the function and role for each device and the connected ports.

To access this page, click **L2 Switching > X-Ring Elite > X-Ring Elite Groups**.



Figure 4.49 L2 Switching > X-Ring Elite > X-Ring Elite Groups

The following table describes the items in the previous figure.

Item	Description
Ring ID	Enter a number to specifies a ranging from 1 to 255 to identify a given X-Ring Elite group.
Role	Click the drop-down menu to select the ring role.
Port 1	Click the drop-down menu to define the port designation.
Port 2	Click the drop-down menu to define the port designation.
Add	Click Add to save the values and update the screen.

The ensuing table for **Information** settings are informational only: Ring ID, Role, Port 1, Port 2 and **Delete** (click to delete the desired Ring ID).

4.5.12 X-Ring Pro

The X-Ring Pro function provides an improvement over Spanning Tree and Rapid Spanning Tree and a rapid auto recovery in the event that the network suffers a corrupt or broken link and prevents network loops.

4.5.12.1 X-Ring Pro Settings

The X-Ring Pro Settings page allows you to configure the status (enabled or disabled) of the function.

To access this page, click **L2 Switching > X-Ring Pro > X-Ring Pro Settings**.

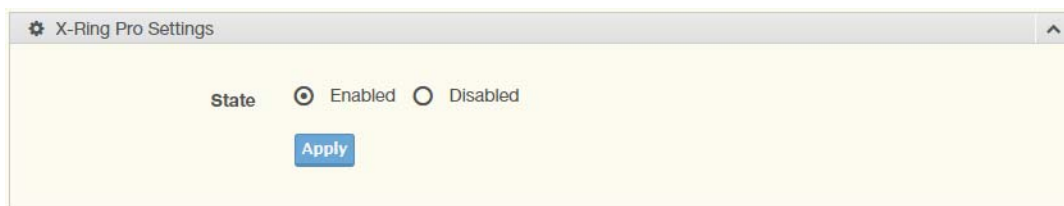

Figure 4.50 L2 Switching > X-Ring Pro > X-Ring Pro Settings

The following table describes the items in the previous figure.

Item	Description
State	Select Enabled or Disabled to setup the X-Ring Pro mode.
Apply	Click Apply to save the values and update the screen.

The ensuing table for **Information** settings are informational only: X-Ring Pro State.

4.5.12.2 X-Ring Pro Groups

The X-Ring Pro Groups page allows you to select the function and role for each ring ID and its connected ports.

To access this page, click **L2 Switching > X-Ring Pro > X-Ring Pro Groups**.

Figure 4.51 L2 Switching > X-Ring Pro > X-Ring Pro Groups > X-Ring Pro Groups Settings

The following table describes the items in the previous figure.

Item	Description
Ring ID	Enter a number to specifies a ranging from 1 to 255 to identify a given X-Ring Pro group.
Port 1	Click the drop-down menu to define the port designation.
Port 2	Click the drop-down menu to define the port designation.
Add	Click Add to save the values and update the screen.

Figure 4.52 L2 Switching > X-Ring Pro > X-Ring Pro Groups > Chain Settings

The following table describes the items in the previous figure.

Item	Description
Chain Ring ID	Enter a number to specifies a ranging from 1 to 255 to identify a chain ring ID.
Role	Click the drop-down menu to select the ring role.
Head Port	Click the drop-down menu to define the port designation.
Member Port	Click the drop-down menu to define the port designation.
Add	Click Add to save the values and update the screen.

Figure 4.53 L2 Switching > X-Ring Pro > X-Ring Pro Groups > Couple Setting

The following table describes the items in the previous figure.

Item	Description
Couple Ring ID	Enter a number to specifies a ranging from 1 to 255 to identify a given X-Ring group.

Item	Description
Port	Enter the port to assign to define the couple setting.
Master Ring ID	Click the drop-down menu to designate the master ring.
Add	Click Add to save the values and update the screen.



Figure 4.54 L2 Switching > X-Ring Pro > X-Ring Pro Groups > Pair Settings

The following table describes the items in the previous figure.

Item	Description
Pair Ring ID	Enter a number to specifies a ranging from 1 to 255 to identify a pair ring ID.
Port	Enter the port to assign to define the couple setting.
Master Ring ID	Click the drop-down menu to designate the master ring.
Add	Click Add to save the values and update the screen.

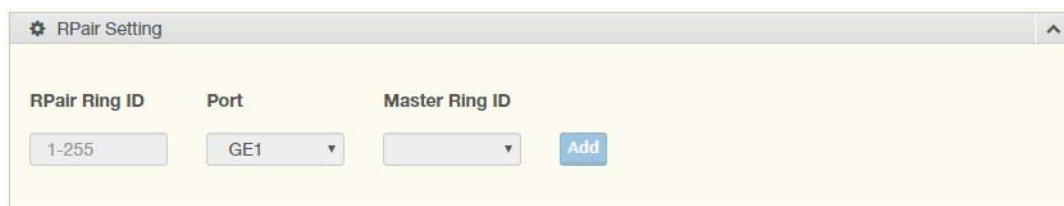

Figure 4.55 L2 Switching > X-Ring Pro > X-Ring Pro Groups > RPair Settings

The following table describes the items in the previous figure.

Item	Description
RPair Ring ID	Enter a number to specifies a ranging from 1 to 255 to identify a rpair ring ID.
Port	Enter the port to assign to define the couple setting.
Master Ring ID	Click the drop-down menu to designate the master ring.
Add	Click Add to save the values and update the screen.

The ensuing table for **Information** settings are informational only: Ring ID, Mode, Role, Operation State, Port 1, Forwarding State, Port 2, Forwarding State and **Delete** (click to delete the desired Ring ID).

4.5.13 Loopback Detection

The Loopback Detection function is used to detect looped links. By sending detection frames and then checking to see if the frames returned to any port on the device, the function is used to detect loops.

4.5.13.1 Global Settings

The Global Settings page allows you to configure the state (enabled or disabled) of the function, select the interval at which frames are transmitted and the delay before recovery.

To access this page, click **L2 Switching > Loopback Detection > Global Settings**.

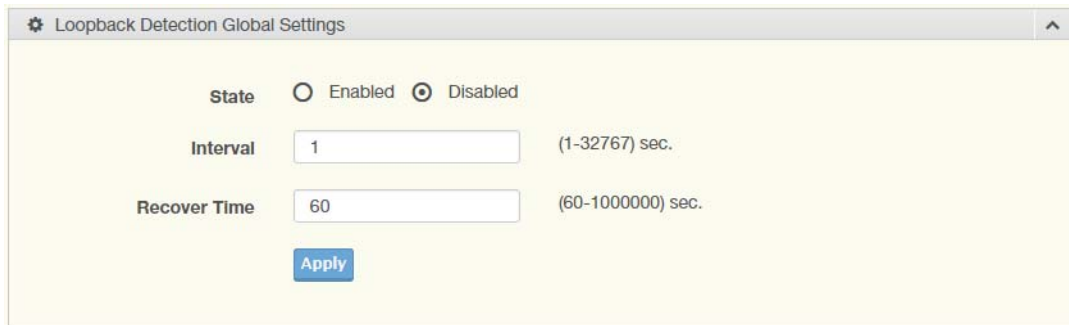

Figure 4.56 L2 Switching > Loopback Detection > Global Settings

The following table describes the items in the previous figure.

Item	Description
State	Select Enabled or Disabled to setup the loopback mode.
Interval	Enter the variable in seconds (1 to 32767) to set the interval at which frames are transmitted.
Recover Time	Enter the variable in seconds (60 to 1000000) to define the delay before recovery.
Apply	Click Apply to save the values and update the screen.

The ensuing table for **Loopback Detection Global Information** settings are informational only: State, Interval and Recover Time.

4.5.13.2 Port Settings

The Port Settings page allows you to select ports that are detected by the loopback detection function and configure their status (enabled or disabled).

To access this page, click **L2 Switching > Loopback Detection > Port Settings**.

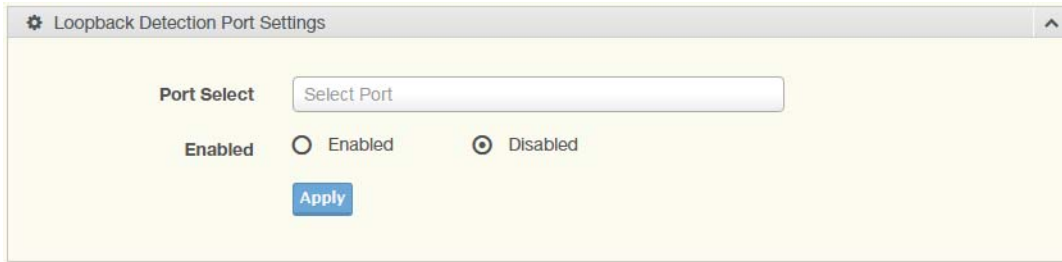

Figure 4.57 L2 Switching > Loopback Detection > Port Settings

The following table describes the items in the previous figure.

Item	Description
Port Select	Enter the port to define the local loopback detection setting.
Enabled	Select Enabled or Disabled to setup the Loopback Detection function.
Apply	Click Apply to save the values and update the screen.

The ensuing table for **Loopback Detection Port Information** settings are informational only: Port, Enable State and Loop Status.

4.5.14 ERPS

4.5.14.1 ERPS Settings

To access this page, click **L2 Switching > ERPS > ERPS Settings**.

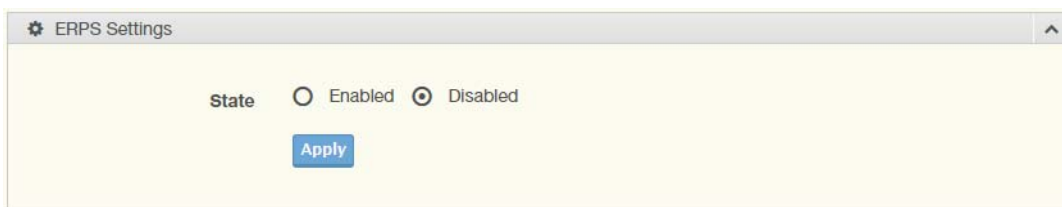

Figure 4.58 L2 Switching > ERPS > ERPS Settings

The following table describes the items in the previous figure.

Item	Description
State	Click Enabled or Disabled to enable ERPS settings.
Apply	Click Apply to save the values and update the screen.

The ensuing table for **Information** settings are informational only: ERPS State.

4.5.14.2 ERPS Groups

To access this page, click **L2 Switching > ERPS > ERPS Groups**.

Figure 4.59 L2 Switching > ERPS > ERPS Groups

The following table describes the items in the previous figure.

Item	Description
ERP Instance	Enter the value to set the ERP instance.
Ring ID	Enter the value to set the ring ID.
Role	Click the drop down menu to select the role. Options include: RPL Owner, RPL Neighbor or Other.
East Link	Enter the port to define the east link.
RPL	Check the check box to enable RPL.
West Link	Enter the port to define the west link.
RPL	Check the check box to enable RPL.
MEL	Enter the value to set minimum equipment list.
R-APS Channel VLAN	Click the drop down menu to select the VLAN.
Traffic Channel Instance	Click the drop down menu to select the traffic channel instance.
Type	Click the drop down menu to select the ERP group type.
WTR Timer	Enter the value to set WTR timer.
Guard Timer	Enter the value to set guard timer.
Hold-off Timer	Enter the value to set hold-off timer.
Apply	Click Apply to save the values and update the screen.

The ensuing table for **Information** settings are informational only: ERP Instance, Ring ID, Role, State, East Link, West Link, MEL, R-APS Channel VLAN, Traffic Channel Instance, Type, WTR Timer, Guard Timer, Hold-off Timer and Delete (Click **Delete** to delete the desired Ring ID).

4.6 MAC Address Table

The MAC Address Table provides access to the Static MAC Settings, MAC Aging Time, and Dynamic Forwarding.

4.6.1 Static MAC

The Static MAC page allows you to configure the address for forwarding of packets, the VLAN ID of the listed MAC address and the designated Port.

To access this page, click **MAC Address Table > Static MAC**.



Figure 4.60 MAC Address Table > Static MAC

The following table describes the items in the previous figure.

Item	Description
MAC Address	Enter the MAC address to which packets are statically forwarded.
VLAN	Click the drop-down menu to select the VLAN ID number of the VLAN for which the MAC address is residing.
Port	Click the drop-down menu to select the port number.
Apply	Click Apply to save the values and update the screen.

The ensuing table for **Static MAC Status** settings are informational only: No., MAC Address, VLAN, Port and **Delete** (click to delete the desired MAC address).

4.6.2 MAC Aging Time

The MAC Aging Time page allows you to set the MAC address of the aging time to study.

To access this page, click **MAC Address Table > MAC Aging Time**.



Figure 4.61 MAC Address Table > MAC Aging Time

The following table describes the items in the previous figure.

Item	Description
Aging Time	Enter the variable (10 to 630) to define the time required for aging.
Apply	Click Apply to save the values and update the screen.

The ensuing table for **Dynamic Address Status** settings are informational only: Aging time.

4.6.3 Dynamic Forwarding Table

The Dynamic Forwarding function allows you to configure an address tables, which contain the following:

- The port each hardware address is associated with
- The VLAN to show or clear dynamic MAC entries
- The MAC address selection

To access this page, click **MAC Address Table > Dynamic Forwarding Table**.

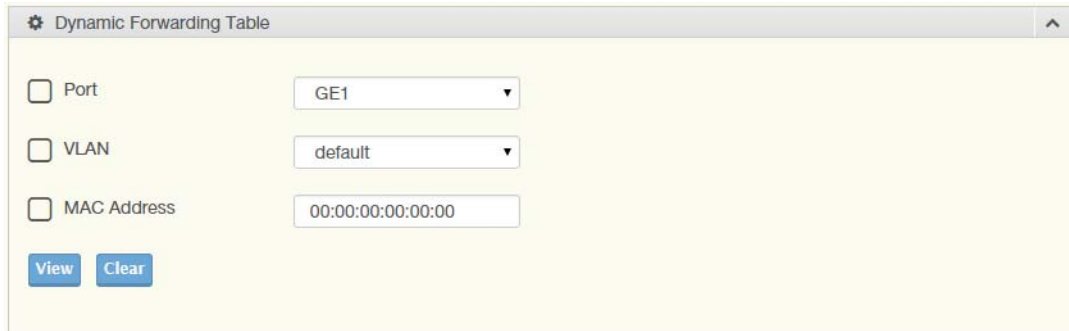

Figure 4.62 MAC Address Table > Dynamic Forwarding Table

The following table describes the items in the previous figure.

Item	Description
Port	Click the drop-down menu to select the port number to show or clear dynamic MAC entries. If a port, VLAN or MAC address is not selected the whole dynamic MAC table is displayed or cleared.
VLAN	Click the drop-down menu to select the VLAN to show or clear dynamic MAC entries.
MAC Address	Enter the MAC address to show or clear dynamic MAC entries. If a port, VLAN or MAC address is not selected the whole dynamic MAC table is displayed or cleared.
View	Click View to display the MAC address information.
Clear	Click Clear to clear the MAC Address Information table.

The ensuing table for **MAC Address Information** settings are informational only: MAC Address, VLAN, Type, Port and **Add to Static MAC** (click to add the MAC address to static MAC address list).

4.7 Security

The Security function allows for the configuration of Storm Control, Port Security, Protected Ports, DoS Prevention, Applications, 802.1x, and IP Security.

4.7.1 Storm Control

The Storm Control page allows you to setup the units and Preamble/IFG to manage the occurrence of packet flooding on the LAN and consequent traffic to prevent the degrading of network performance.

4.7.1.1 Global Settings

To access this page, click **Security > Storm Control > Global Settings**.

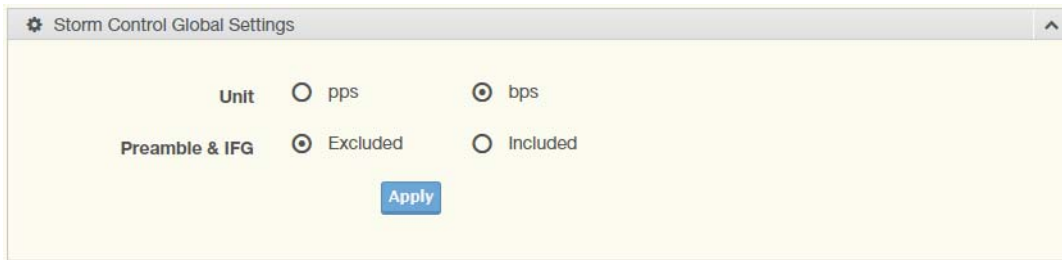

Figure 4.63 Security > Storm Control > Global Settings

The following table describes the items in the previous figure.

Item	Description
Unit	Select pps or bps control units for the Storm Control function.
Preamble & IFG	Select Excluded or Included to setup the Storm Control Global settings. <ul style="list-style-type: none">■ Excluded: exclude preamble & IFG (20 bytes) when count ingress storm control rate.■ Included: include preamble & IFG (20 bytes) when count ingress storm control rate.
Apply	Click Apply to save the values and update the screen.

The ensuing table for **Storm Control Global Information** settings are informational only: Unit and Preamble & IFG.

4.7.1.2 Port Settings

The Port Settings page allows you to configure the port and the type of storm control association along with the value of the storm rate for the selected port.

To access this page, click **Security > Storm Control > Port Settings**.

Figure 4.64 Security > Storm Control > Port Settings

The following table describes the items in the previous figure.

Item	Description
Port	Enter the port number to designate the local port for the Storm Control function.
Port State	Select Disabled or Enabled to define the port state
Action	Click the drop-down menu to select the type of action to designate for the selected port during a Storm Control incident. The options are Drop and Shutdown.
Type Enable	Click the radio button to enable Broadcast, Unknown Multicast, or Unknown Unicast. <ul style="list-style-type: none"> ■ Broadcast: Select the variable in Kbps to define the broadcast bandwidth. ■ Unknown Multicast: Select the variable in Kbps to define the unknown multicast setting. ■ Unknown Unicast: Select the variable in Kbps to define the unknown unicast setting.
Apply	Click Apply to save the values and update the screen.

The ensuing table for **Storm Control Port Information** settings are informational only: Port, Port State, Broadcast (Kbps), Unknown Multicast (Kbps), Unknown Unicast (Kbps) and Action.

4.7.2 Port Security

The Port Security page allows you to configure port isolation behavior. To access this page, click **Security > Port Security**.

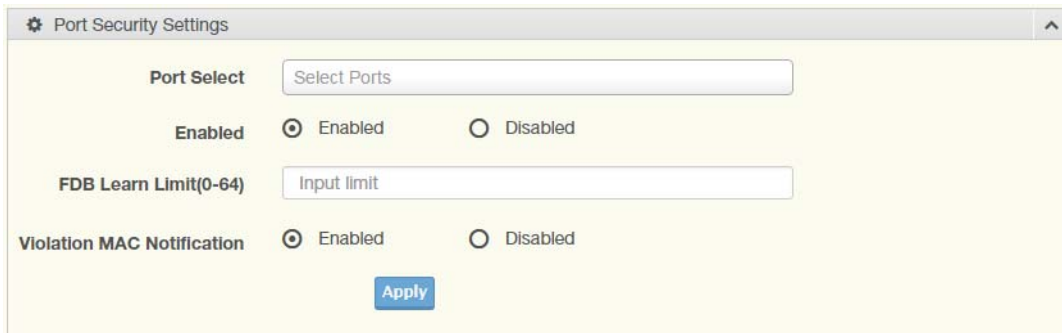

Figure 4.65 Security > Port Security

The following table describes the items in the previous figure.

Item	Description
Port Select	Enter a single or multiple port numbers to configure.
Enabled	Select Enabled or Disabled to define the selected Port.
FDB Learn Limit (0-64)	Enter the variable (0 to 64) to set the learn limit for the FDB setting.
Violation MAC Notification	Select Enabled or Disabled to define the selected Port.
Apply	Click Apply to save the values and update the screen.

The ensuing table for **Port Security Information** settings are informational only: Port, Enabled, FDB Learn Limit and Violation MAC Notification.

4.7.3 Protected Ports

The Protected Port page allows you to configure a single or multiple ports as a protected or unprotected type.

To access this page, click **Security > Protected Ports**.

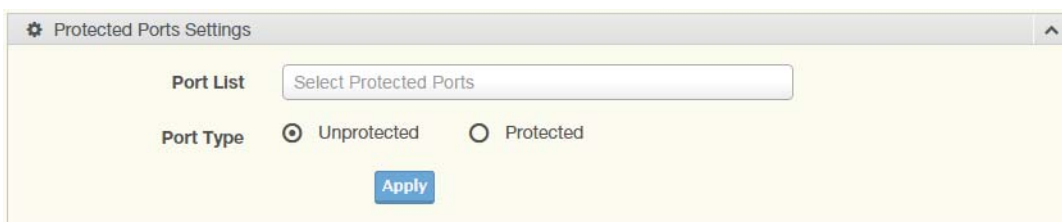

Figure 4.66 Security > Protected Ports

The following table describes the items in the previous figure.

Item	Description
Port List	Enter the port number to designate for the Protected Port setting.
Port Type	Select Unprotected or Protected to define the port type.
Apply	Click Apply to save the values and update the screen.

The ensuing table for **Protected Ports Status** settings are informational only: Protected Ports and Unprotected Ports.

4.7.4 DoS Prevention

The DoS Prevention page allows you to setup (enabled or disabled) the denial of service.

4.7.4.1 DoS Global Settings

The DoS Global Settings page allows you to configure (enabled or disabled) the setting for each function.

To access this page, click **Security > DoS Prevention > DoS Global Settings**.

Item	Description
DMAC = SMAC	<input checked="" type="radio"/> Enabled <input type="radio"/> Disabled
LAND	<input checked="" type="radio"/> Enabled <input type="radio"/> Disabled
UDP Blat	<input checked="" type="radio"/> Enabled <input type="radio"/> Disabled
TCP Blat	<input checked="" type="radio"/> Enabled <input type="radio"/> Disabled
POD	<input checked="" type="radio"/> Enabled <input type="radio"/> Disabled
IPv6 Min Fragment	<input checked="" type="radio"/> Enabled <input type="radio"/> Disabled Bytes: 1240 (0-65535)
ICMP Fragments	<input checked="" type="radio"/> Enabled <input type="radio"/> Disabled
IPv4 Ping Max Size	<input checked="" type="radio"/> Enabled <input type="radio"/> Disabled
IPv6 Ping Max Size	<input checked="" type="radio"/> Enabled <input type="radio"/> Disabled
Ping Max Size Setting	<input checked="" type="radio"/> Enabled <input type="radio"/> Disabled Bytes: 512 (0-65535)
Smurf Attack	<input checked="" type="radio"/> Enabled <input type="radio"/> Disabled Netmask Length: 0 (0-32)
TCP Min Hdr Size	<input checked="" type="radio"/> Enabled <input type="radio"/> Disabled Byte: 20 (0-31)
TCP-SYN(SPORT<1024)	<input checked="" type="radio"/> Enabled <input type="radio"/> Disabled
Null Scan Attack	<input checked="" type="radio"/> Enabled <input type="radio"/> Disabled
X-Mas Scan Attack	<input checked="" type="radio"/> Enabled <input type="radio"/> Disabled
TCP SYN-FIN Attack	<input checked="" type="radio"/> Enabled <input type="radio"/> Disabled
TCP SYN-RST Attack	<input checked="" type="radio"/> Enabled <input type="radio"/> Disabled
TCP Fragment (Offset = 1)	<input checked="" type="radio"/> Enabled <input type="radio"/> Disabled

Figure 4.67 Security > DoS Prevention > DoS Global Settings

The following table describes the items in the previous figure.

Item	Description
DMAC = SMAC	Click Enabled or Disabled to define DMAC-SMAC for the DoS Global settings.
LAND	Click Enabled or Disabled to define LAND for the DoS Global settings.

Item	Description
UDP Blat	Click Enabled or Disabled to define UDP Blat for the DoS Global settings.
TCP Blat	Click Enabled or Disabled to define TCP Blat for the DoS Global settings.
POD	Click Enabled or Disabled to define POD for the DoS Global settings.
IPv6 Min Fragment	Click Enabled or Disabled to define minimum fragment size for the IPv6 protocol. Enter the variable in bytes (0 to 65535) to set the minimum fragment size when the function is enabled.
ICMP Fragments	Click Enabled or Disabled to define the ICMP Fragments function.
IPv4 Ping Max Size	Click Enabled or Disabled to set the maximum ping size for the IPv4 protocol.
IPv6 Ping Max Size	Click Enabled or Disabled to set a maximum ping size for the IPv6 protocol.
Ping Max Size Setting	Enter the variable in bytes (0 to 65535) to set the maximum ping size.
Smurf Attack	Click Enabled or Disabled to set the Smurf Attack function.
TCP Min Hdr Size	Click Enabled or Disabled to set the minimum header size. Enter the variable in bytes (0 to 31) to set the minimum header size.
TCP-SYN (SPORT < 1024)	Click Enabled or Disabled to set the TCP synchronization function (sport < 1021).
Null Scan Attack	Click Enabled or Disabled to set the Null Scan Attack function.
X-Mas Scan Attack	Click Enabled or Disabled to set the X-Mas Scan function.
TCP SYN-FIN Attack	Click Enabled or Disabled to set the TCP synchronization termination attack function.
TCP SYN-RST Attack	Click Enabled or Disabled to set the TCP synchronization reset attack function.
TCP Fragment (Offset = 1)	Click Enabled or Disabled to set the TCP fragment function (offset =1).
Apply	Click Apply to save the values and update the screen.

The ensuing table for **DoS Global Information** settings are informational only: DMAC = SMAC, Land Attack, UDP Blat, TCP Blat, POD (Ping of Death), IPv6 Min Fragment Size, ICMP Fragment Packets, IPv4 Ping Max Packet Size, IPv6 Ping Max Packet Size, Smurf Attack, TCP Min Header Length, TCP Syn (SPORT < 1024), Null Scan Attack, X-Mas Scan Attack, TCP SYN-FIN Attack, TCP SYN-RST Attack and TCP Fragment (Offset = 1).

4.7.4.2 DoS Port Settings

The DoS Port Settings page allow you to configure DoS security (enabled or disabled) for the selected port.

To access this page, click **Security > DoS Prevention > DoS Port Settings**.

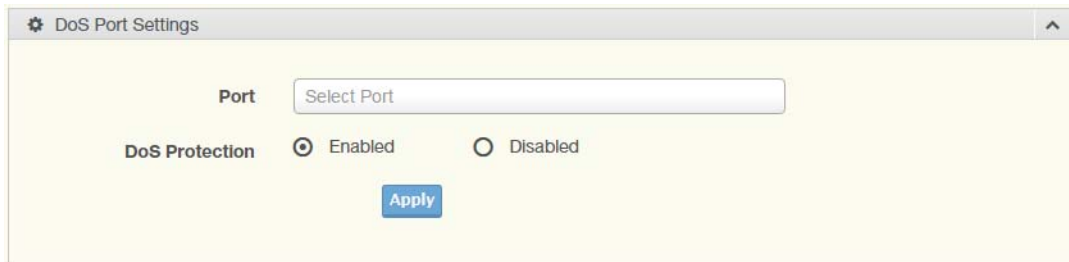

Figure 4.68 Security > DoS Prevention > DoS Port Settings

The following table describes the items in the previous figure.

Item	Description
Port	Select the port to configure for the DoS prevention function.
DoS Protection	Click Enabled or Disabled to set the DoS Port security function state.
Apply	Click Apply to save the values and update the screen.

The ensuing table for **DoS Port Status** settings are informational only: Port and DoS Protection.

4.7.5 Applications

The Applications function allows you to configure various types of AAA lists.

4.7.5.1 TELNET

The TELNET page allows you to combine all kinds of AAA lists with the Telnet line.

To access this page, click **Security > Applications > TELNET**.

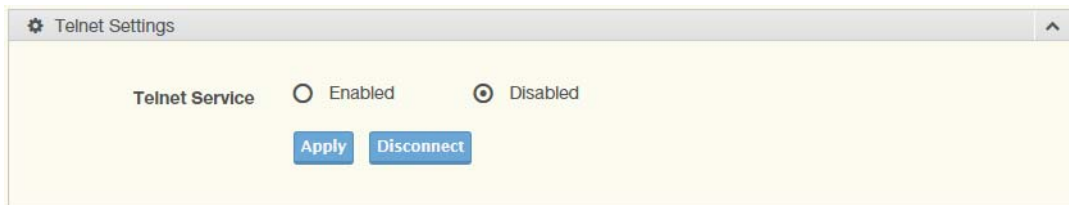

Figure 4.69 Security > Applications > TELNET

The following table describes the items in the previous figure.

Item	Description
Telnet Service	Click Enabled or Disabled to set remote access through the Telnet Service function.
Apply	Click Apply to save the values and update the screen.
Disconnect	Click Disconnect to disable the current Telnet service.

The ensuing table for **Telnet Information** settings are informational only: Telnet Service and Current Telnet Sessions Count.

4.7.5.2 SSH

Secure Shell (SSH) is a protocol providing secure (encrypted) management connection to a remote device.

To access this page, click **Security > Applications > SSH**.



Figure 4.70 Security > Applications > SSH

The following table describes the items in the previous figure.

Item	Description
SSH Service	Click Enabled or Disabled to set up Ethernet encapsulation (remote access) through the Secure Shell (SSH) function.
Apply	Click Apply to save the values and update the screen.

The ensuing table for **SSH Information** settings are informational only: SSH.

4.7.5.3 HTTP

The HTTP page allows you to combine all kinds of AAA lists to the HTTP line. Attempts to access the switch's Web UI from HTTP are first authenticated.

To access this page, click **Security > Applications > HTTP**.

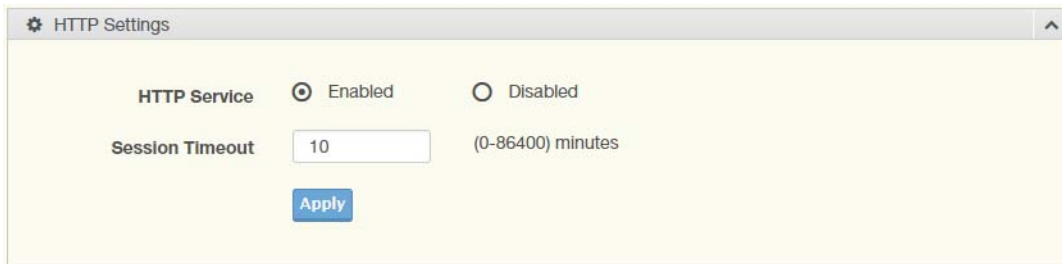

Figure 4.71 Security > Applications > HTTP

The following table describes the items in the previous figure.

Item	Description
HTTP Service	Click Enabled or Disabled to set up Ethernet encapsulation (remote access) through HTTP function.
Session Timeout	Enter the variable in minutes (0 to 86400) to define the timeout period for the HTTP session.
Apply	Click Apply to save the values and update the screen.

The ensuing table for **HTTP Information** settings are informational only: HTTP Service and Session Timeout.

4.7.5.4 HTTPS

The HTTPS page allows you to combine all kinds of AAA lists on the HTTPS line. Attempts to access the switch's Web UI from HTTPS are first authenticated.

To access this page, click **Security > Applications > HTTPS**.

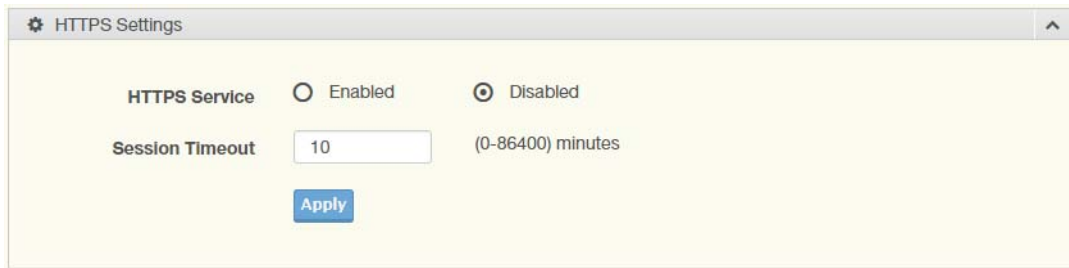

Figure 4.72 Security > Applications > HTTPS

The following table describes the items in the previous figure.

Item	Description
HTTPS Service	Click Enabled or Disabled to set up Ethernet encapsulation over HTTPS.
Session Timeout	Enter the variable in minutes (0 to 86400) to define the timeout period for the HTTP session.
Apply	Click Apply to save the values and update the screen.

The ensuing table for **HTTPS Information** settings are informational only: HTTPS Service and Session Timeout.

4.7.6 802.1x

The 802.1x function provides port-based authentication to prevent unauthorized devices (clients) from gaining access to the network.

4.7.6.1 802.1x Global Settings

The 802.1x Global Settings page allows you to set the state (enabled or disabled) for the selected IP server address, port, accounting port and associated password, including a reauthentication period.

To access this page, click **Security > 802.1x > 802.1x Global Settings**.

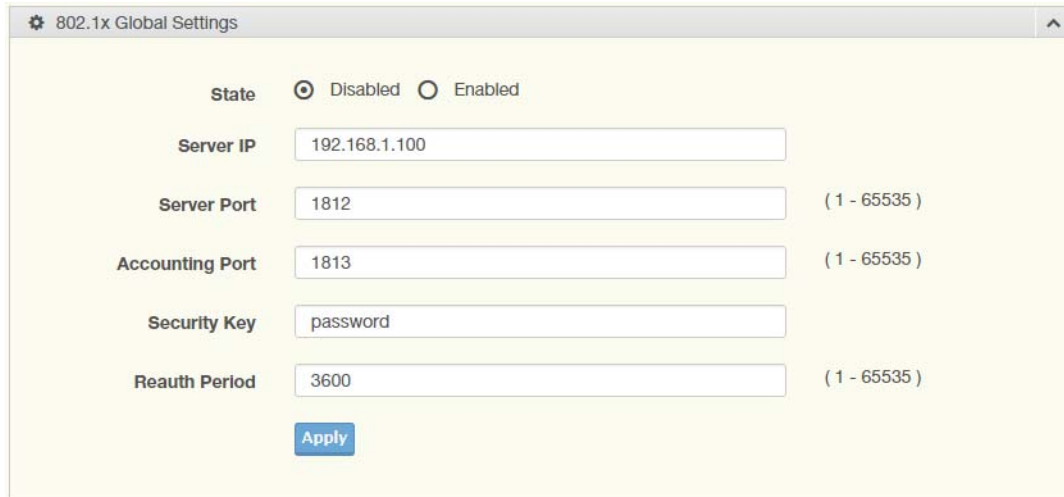

Figure 4.73 Security > 802.1x > 802.1x Global Settings

The following table describes the items in the previous figure.

Item	Description
State	Click Enabled or Disabled to set up 802.1x Setting function.
Server IP	Enter the IP address of the local server providing authentication function.
Server Port	Enter the port number (1 to 65535) assigned to the listed Server IP.
Accounting Port	Enter the port number (1 to 65535) assigned to the listed server IP configured to provide authorization and authentication for network access.
Security Key	Enter the variable to define the network security key used in authentication.
Reauth Period	Enter the variable in seconds to define the period of time between authentication attempts.
Apply	Click Apply to save the values and update the screen.

The ensuing table for **802.1x Information** settings are informational only: 802.1x State, Server IP, Server Port, Accounting Port, Security Key and Reauth Period.

4.7.6.2 802.1x Port Configuration

The 802.1x Port Configuration page allows you to identify the authorization state for a port by using a MAC or Port authentication base.

To access this page, click **Security > 802.1x > 802.1x Port Configuration**.

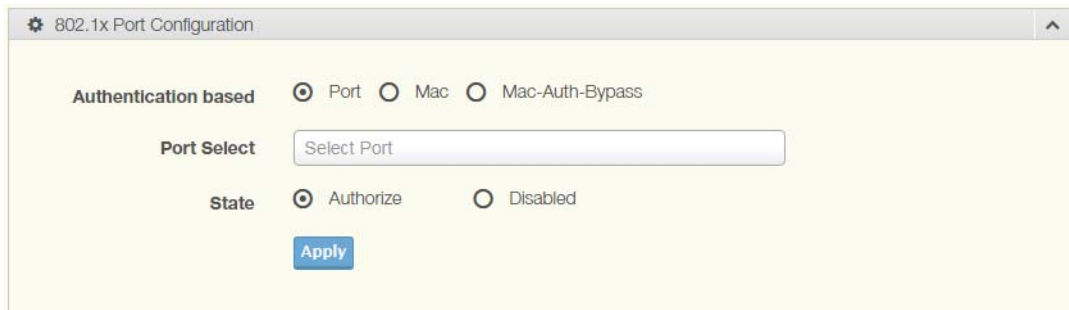

Figure 4.74 Security > 802.1x > 802.1x Port Configuration

The following table describes the items in the previous figure.

Item	Description
Authentication based	Click Port , Mac or Mac-Auth-Bypass to designate the type of configuration for the 802.1x Port setting.
Port Select	Enter the port number associated with the configuration setting.
State	Click Authorize or Disabled to define the listed port's state mode.
Apply	Click Apply to save the values and update the screen.

The ensuing table for **802.1x Port Authorization** settings are informational only: Port and Port State.

4.7.7 IP Security

This section provides you a means to configure the IP Security settings.

4.7.7.1 Global Settings

The Global Settings page allows you to set the IP Security status (enabled or disabled).

To access this page, click **Security > IP Security > Global Settings**.



Figure 4.75 Security > IP Security > Global Settings

The following table describes the items in the previous figure.

Item	Description
Status	Click Enabled or Disabled to define the global setting for the IP security function.
Apply	Click Apply to save the values and update the screen.

The ensuing table for **IP Security Status** settings are informational only: IP Security.

4.7.7.2 Entry Settings

Once the Global Setting is enabled, use the Entry Settings to define an IP Security entry.

To access this page, click **Security > IP Security > Entry Settings**.



Figure 4.76 Security > IP Security > Entry Settings

The following table describes the items in the previous figure.

Item	Description
IP Address	Enter the source IP address to apply the IP Security function.
IP Mask	Enter the IP address for use in masking the previous IP Address.
Services	Enter the type of services to associate with the entry setting.
Apply	Click Apply to save the values and update the screen.

The ensuing table for **IP Security Entry Information** settings are informational only: IP Address, IP Mask, Services and Action.

4.7.8 Security Login

4.7.8.1 Global Settings

This function provides a means to enable or disable the global security settings for the system.

To access this page, click **Security > Security Login > Global Settings**.

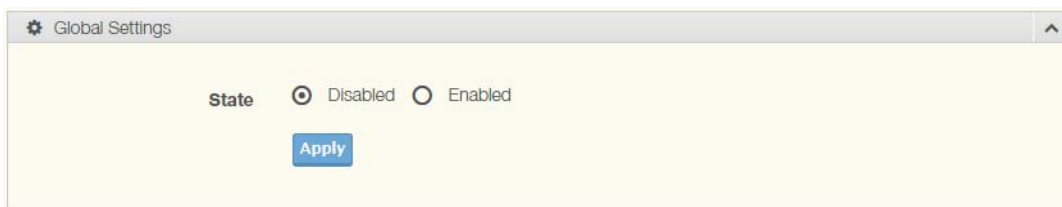

Figure 4.77 Security > Security Login > Global Settings > Global Settings

The following table describes the items in the previous figure.

Item	Description
State	Click Enabled or Disabled to set up security login global setting status.
Apply	Click Apply to save the values and update the screen.

Figure 4.78 Security > Security Login > Global Settings > RADIUS Settings

The following table describes the items in the previous figure.

Item	Description
Server IP	Enter the IP address of the local server providing authentication function.
Server Port	Enter the port number (1 to 65535) assigned to the listed Server IP.
Security Key	Enter the variable to define the network security key used in authentication.
Apply	Click Apply to save the values and update the screen.

Figure 4.79 Security > Security Login > Global Settings > TACACS Settings

The following table describes the items in the previous figure.

Item	Description
Server IP	Enter the IP address of the local server providing authentication function.
Server Port	Enter the port number (1 to 65535) assigned to the listed Server IP.
Security Key	Enter the variable to define the network security key used in authentication.
Apply	Click Apply to save the values and update the screen.

The ensuing table for **Global Information** settings are informational only: State, RADIUS Server IP, RADIUS Server Port, RADIUS Security Key, TACACS Server IP, TACACS Server Port and TACACS Security Key.

4.7.8.2 Access Control Settings

This function specifies the login authentication type for the system.

To access this page, click **Security > Security Login > Security Login Access Control Settings**.



Figure 4.80 Security > Security Login > Access Control Settings > Security Login Type Settings

The following table describes the items in the previous figure.

Item	Description
Login Type	Click to select the login type. Options include: None Used, RADIUS Only, TACACS Only, RADIUS & TACACS or RADIUS & TACACS & WEB.
Apply	Click Apply to save the values and update the screen.

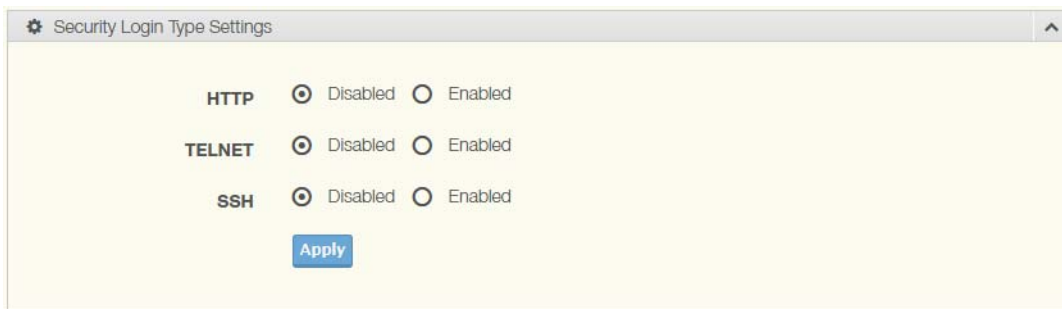

Figure 4.81 Security > Security Login > Access Control Settings > Security Login Type Settings

The following table describes the items in the previous figure.

Item	Description
HTTP	Click Enabled or Disabled to set up HTTP.
TELNET	Click Enabled or Disabled to set up HTTPS.
SSH	Click Enabled or Disabled to set up SSH.
Apply	Click Apply to save the values and update the screen.

The ensuing table for **Access Control Information** settings are informational only: Login Type, HTTP, TELNET and SSH.

4.7.9 Access Control List

4.7.9.1 MAC ACL

Entry Settings

To access this page, click **Security > Access Control List > MAC ACL > Entry Settings**.

The screenshot shows the 'Entry Settings' window with the following fields and values:

- Entry ID: Input Entry ID (1-250)
- Destination MAC Address: Input MAC Address (ex: 00:11:22:33:44:55)
- Destination MAC Mask: Input MAC Mask
- Source MAC Address: Input MAC Address (ex: 00:11:22:33:44:55)
- Source MAC Mask: Input MAC Mask
- Ether Type: Input Ether Type (1-65535)
- VLAN ID: Input VLAN ID (1-4094)
- Portlist: Select Port
- Action: Permit
- Status: Active

An 'Add' button is located at the bottom of the form.

Figure 4.82 Security > Access Control List > MAC ACL > Entry Settings

The following table describes the items in the previous figure.

Item	Description
Entry ID	Type in the value designating the entry ID.
Destination MAC Address	Enter the MAC address to set destination MAC address.
Destination MAC Mask	Enter a value to specify the subnet mask for the destination MAC address.
Source MAC Address	Enter the MAC address to set source MAC address.
Source MAC Mask	Enter a value to specify the subnet mask for the source MAC address.
Ether Type	Enter a value to specify the DNS server for the interface.
VLAN ID	Type in the value designating the VLAN ID.
Portlist	Select the port to configure for the MAC ACL function.
Action	Click the drop down menu to select the MAC ACL action. Options include: Permit, Drop or Assign Queue.
Assign Queue	Click the drop down menu to select the queue. The function is only available when Action is Assign Queue .
Status	Click the drop down menu to select the MAC ACL status. Options include: Active or Inactive.
Add	Click Add to add a MAC ACL entry.

Entry List

To access this page, click **Security > Access Control List > MAC ACL > Entry List**. The ensuing table for **MAC ACL Information** settings are informational only: Entry ID, Summary, Portlist, Action, Status and Modify (Click **Edit** to edit the desired entry id or **Delete** to delete the desired entry id).

4.7.9.2 IP ACL

Entry Settings

To access this page, click **Security > Access Control List > IP ACL > Entry Settings**.

The screenshot shows the 'Entry Settings' window with the following fields and values:

- Entry ID: Input Entry ID (1-250)
- Destination IP Address: Input IP Address (ex: 192.168.1.1)
- Destination IP Mask: Input IP Mask (ex: 255.255.0.0)
- Source IP Address: Input IP Address (ex: 192.168.2.1)
- Source IP Mask: Input IP Mask (ex: 255.255.0.0)
- IP Protocol: none
- L4 Destination Port: Input L4 Port (1-65535)
- L4 Source Port: Input L4 Port (1-65535)
- Portlist: Select Port
- Action: Permit
- Status: Active

An 'Add' button is located at the bottom left of the form area.

Figure 4.83 Security > Access Control List > IP ACL > Entry Settings

The following table describes the items in the previous figure.

Item	Description
Entry ID	Type in the value designating the entry ID.
Destination IP Address	Enter the IP address to set destination IP address.
Destination IP Mask	Enter a value to specify the subnet mask for the destination IP address.
Source IP Address	Enter the IP address to set source IP address.
Source IP Mask	Enter a value to specify the subnet mask for the source IP address.
IP Protocol	Click the drop down menu to select the IP protocol. Options include: none, ICMP, TCP or UDP.
L4 Destination Port	Enter a value to specify the L4 destination port.
L4 Source Port	Enter a value to specify the L4 source port.
Portlist	Select the port to configure for the IP ACL function.
Action	Click the drop down menu to select the IP ACL action. Options include: Permit, Drop or Assign Queue.

Item	Description
Assign Queue	Click the drop down menu to select the queue. The function is only available when Action is Assign Queue .
Status	Click the drop down menu to select the IP ACL status. Options include: Active or Inactive.
Add	Click Add to add an IP ACL entry.

Entry List

To access this page, click **Security > Access Control List > IP ACL > Entry List**.

The ensuing table for **IP ACL Information** settings are informational only: Entry ID, Summary, Portlist, Action, Status and Modify (Click **Edit** to edit the desire entry id or **Delete** to delete the desired entry id).

4.7.10 IP Source Guard

4.7.10.1 Global Settings

To access this page, click **Security > IP Source Guard > Global Settings**.



Figure 4.84 Security > IP Source Guard > Global Settings

The following table describes the items in the previous figure.

Item	Description
Portlist	Select the port to verify.
Modify	Click Modify to save the values and update the screen.

The ensuing table for **Global Information** settings are informational only: Verify Ports.

4.7.10.2 Entry Settings

To access this page, click **Security > IP Source Guard > Entry Settings**.



Figure 4.85 Security > IP Source Guard > Entry Settings

The following table describes the items in the previous figure.

Item	Description
Source MAC Address	Enter the MAC address to set source MAC address.
Source IP Address	Enter the IP address to set source IP address.

Item	Description
Port	Select the port to configure for the IP source guard.
Add	Click Add to add an IP source guard.

The ensuing table for **Entry Information** settings are informational only: Source MAC, Source IP, Port and Modify (Click **Delete** to delete the desired option).

4.7.11 DHCP Snooping

4.7.11.1 Global Settings

To access this page, click **Security > DHCP Snooping > Global Settings**.

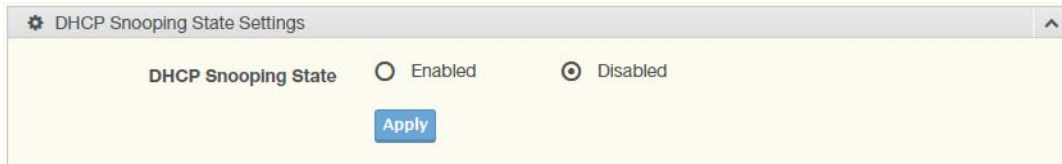

Figure 4.86 Security > DHCP Snooping > Global Settings > DHCP Snooping State Settings

The following table describes the items in the previous figure.

Item	Description
DHCP Snooping State	Click Enabled or Disabled to set DHCP snooping state.
Apply	Click Apply to save the values and update the screen.

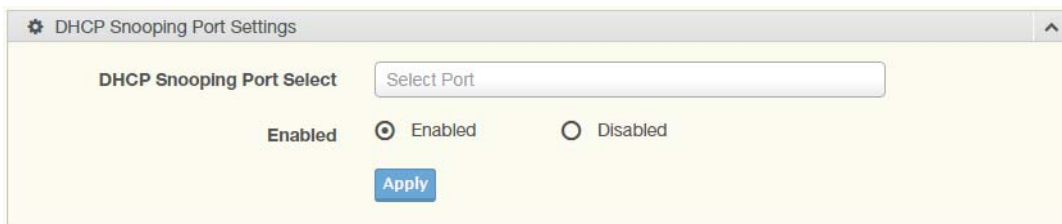

Figure 4.87 Security > DHCP Snooping > Global Settings > DHCP Snooping Port Settings

The following table describes the items in the previous figure.

Item	Description
DHCP Snooping Port Select	Select the port to configure for the DHCP Snooping port.
Enabled	Click Enabled or Disabled to enable DHCP Snooping port.
Apply	Click Apply to save the values and update the screen.

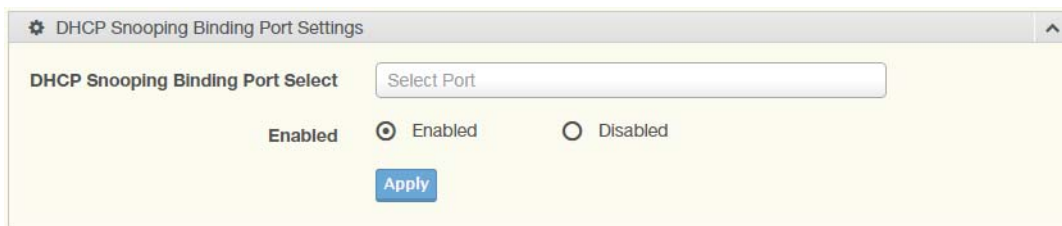

Figure 4.88 Security > DHCP Snooping > Global Settings > DHCP Snooping Binding Port Settings

The following table describes the items in the previous figure.

Item	Description
DHCP Snooping Binding Port Select	Select the port to configure for the DHCP snooping binding port.
Enabled	Click Enabled or Disabled to enable DHCP Snooping binding.
Apply	Click Apply to save the values and update the screen.

The ensuing table for **DHCP Snooping Information** settings are informational only: DHCP Snooping, DHCP Snooping Port and DHCP Snooping Binding Port.

4.7.11.2 Entry Settings

To access this page, click **Security > DHCP Snooping > Entry Settings**.

The ensuing table for **IP Security Entry Information** settings are informational only: MAC Address, IP Address, Lease Time, VLAN Id and Port.

4.7.12 ARP Spoofing

To access this page, click **Security > ARP Spoofing**.



Figure 4.89 Security > ARP Spoofing

The following table describes the items in the previous figure.

Item	Description
Source MAC Address	Enter the MAC address to set source MAC address.
Source IP Address	Enter the IP address to set source IP address.
Add	Click Add to add an ARP spoofing.

The ensuing table for **Entry Information** settings are informational only: Source MAC, Source IP and Modify.

4.8 QoS

The QoS function allows you to configure settings for the switch QoS interface and how the switch connects to a remote server to get services.

4.8.1 General

Traditionally, networks operate on a best-effort delivery basis, all traffic has equal priority and an equal chance of being delivered in a timely manner. When there is congestion, all traffic has an equal chance of being dropped.

The QoS feature can be configured for congestion-management and congestion-avoidance to specifically manage the priority of the traffic delivery. Implementing QoS in the network makes performance predictable and bandwidth utilization much more effective.

The QoS implementation is based on the prioritization values in Layer 2 frames.

4.8.1.1 QoS Properties

The QoS Properties allows you to set the QoS mode.

To access this page, click **QoS > General > QoS Properties**.



Figure 4.90 QoS > General > QoS Properties

The following table describes the items in the previous figure.

Item	Description
QoS Mode	Select Disabled or Basic to setup the QoS function.
Apply	Click Apply to save the values and update the screen.

The ensuing table for **QoS Global Information** settings are informational only: QoS Mode.

4.8.1.2 QoS Settings

Once the QoS function is enabled, you can configure the available settings. To access this page, click **QoS > General > QoS Settings**.

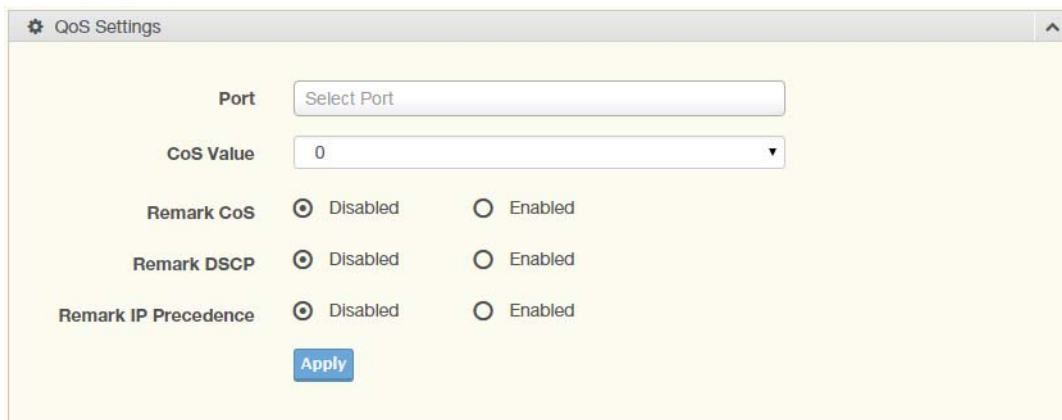

Figure 4.91 QoS > General > QoS Settings

The following table describes the items in the previous figure.

Item	Description
Port	Enter the port number to associate with the QoS setting.
CoS Value	Click the drop-down menu to designate the Class of Service (CoS) value (0 to 7) for the Port entry.
Remark CoS	Click Disabled or Enabled to setup the Remark CoS function. When enabled the LAN (preassigned priority values) is marked at Layer 2 boundary to CoS values.
Remark DSCP	Click Disabled or Enabled to setup the DSCP remark option for the QoS function.
Remark IP Precedence	Click Disabled or Enabled to setup the Remark IP Precedence for the QoS function.
Apply	Click Apply to save the values and update the screen.

The ensuing table for **QoS Status** settings are informational only: Port, CoS value, Remark CoS, Remark DSCP and Remark IP Precedence.

4.8.1.3 Queue Scheduling

The switch support eight CoS queues for each egress port. For each of the eight queues, two types of scheduling can be configured: Strict Priority and Weighted Round Robin (WRR).

Strict Priority scheduling is based on the priority of queues. Packets in a high-priority queue are always sent first and packets in a low-priority queue are only sent after all the high priority queues are empty.

Weighted RoundRobin (WRR) scheduling is based on the user priority specification to indicate the importance (weight) of the queue relative to the other CoS queues. WRR scheduling prevents low-priority queues from being completely ignored during periods of high priority traffic. The WRR scheduler sends some packets from each queue in turn.

To access this page, click **QoS > General > QoS Scheduling**.

Queue	Strict	WRR	Weight	% of WRR Bandwidth
1	<input checked="" type="radio"/>	<input type="radio"/>	1	
2	<input checked="" type="radio"/>	<input type="radio"/>	2	
3	<input checked="" type="radio"/>	<input type="radio"/>	3	
4	<input checked="" type="radio"/>	<input type="radio"/>	4	
5	<input checked="" type="radio"/>	<input type="radio"/>	5	
6	<input checked="" type="radio"/>	<input type="radio"/>	9	
7	<input checked="" type="radio"/>	<input type="radio"/>	13	
8	<input checked="" type="radio"/>	<input type="radio"/>	15	

Apply

Figure 4.92 QoS > General > QoS Scheduling

The following table describes the items in the previous figure.

Item	Description
Queue	Queue entry for egress port.
Strict	Select Strict to assign the scheduling designation to the selected queue.
WRR	Select WRR to assign the scheduling designation to the selected queue.
Weight	Enter a queue priority (weight) relative to the defined entries (WRR only).
% of WRR Bandwidth	Displays the allotted bandwidth for the queue entry in percentage values.
Apply	Click Apply to save the values and update the screen.

The ensuing table for **Queue Information** settings are informational only: Strict Priority Queue Number.

4.8.1.4 CoS Mapping

The CoS Mapping allows you to apply CoS mapping.

To access this page, click **QoS > General > CoS Mapping**.

CoS to Queue Mapping			
Class of Service	Queue	Class of Service	Queue
0	2	1	1
2	3	3	4
4	5	5	6
6	7	7	8

Queue to CoS Mapping			
Queue	Class of Service	Queue	Class of Service
1	1	2	0
3	2	4	3
5	4	6	5
7	6	8	7

[Apply](#)

Figure 4.93 QoS > General > CoS Mapping

The following table describes the items in the previous figure.

Item	Description
CoS to Queue Mapping	
Class of Service	Displays the CoS for the queue entry.
Queue	Click the drop-down menu to select the queue priority for selected CoS.
Queue to CoS Mapping	
Queue	Displays the queue entry for CoS mapping.
Class of Service	Click the drop-down menu to select the CoS type
Apply	Click Apply to save the values and update the screen.

The ensuing table for **CoS Mapping Information** settings are informational only: CoS and Mapping to Queue.

The ensuing table for **Queue Mapping Information** settings are informational only: Queue and Mapping to CoS.

4.8.1.5 DSCP Mapping

The DSCP to Queue mapping function maps queue values in incoming packets to a DSCP value that QoS uses internally to represent the priority of the traffic. The following table shows the DSCP to Queue map.

If these values are not appropriate for your network, you need to modify them.

To access this page, click **QoS > General > DSCP Mapping**.

Figure 4.94 QoS > General > DSCP Mapping

The following table describes the items in the previous figure.

Item	Description
DSCP to Queue Mapping	
DSCP	Enter the DSCP entry to define the precedence values.
Queue	Click the drop-down menu to select the queue designation for the DSCP value.
Queue to DSCP Mapping	
Queue	Displays the queue value for the DSCP map.
DSCP	Enter the DSCP entry to define the precedence values.
Apply	Click Apply to save the values and update the screen.

The ensuing table for **DSCP Mapping Information** settings are informational only: DSCP and Mapping to Queue.

The ensuing table for **Queue Mapping Information** settings are informational only: Queue and Mapping to DSCP.

4.8.1.6 IP Precedence Mapping

The IP Precedence Mapping allows you to set IP Precedence mapping. To access this page, click **QoS > General > IP Precedence Mapping**.

The screenshot shows the 'IP Precedence Mapping' configuration page. It is divided into two main sections:

- IP Precedence to Queue Mapping:** This section contains two columns. The left column lists IP Precedence values from 0 to 7, and the right column lists Queue values from 1 to 8. Each IP Precedence value is mapped to a Queue value via a drop-down menu. For example, IP Precedence 0 is mapped to Queue 1, and IP Precedence 7 is mapped to Queue 8.
- Queue to IP Precedence Mapping:** This section also contains two columns. The left column lists Queue values from 1 to 7, and the right column lists IP Precedence values from 0 to 7. Each Queue value is mapped to an IP Precedence value via a drop-down menu. For example, Queue 1 is mapped to IP Precedence 0, and Queue 8 is mapped to IP Precedence 7.

An 'Apply' button is located at the bottom center of the page.

Figure 4.95 QoS > General > IP Precedence Mapping

The following table describes the items in the previous figure.

Item	Description
IP Precedence to Queue Mapping	
IP Precedence	Displays the IP precedence value for the queue map.
Queue	Click the drop-down menu to map a queue value to the selected IP precedence.
Queue to IP Precedence Mapping	
Queue	Displays the queue entry for mapping IP precedence values.
IP Precedence	Click the drop-down menu to map an IP precedence value to the selected queue.
Apply	Click Apply to save the values and update the screen.

The ensuing table for **IP Precedence Mapping Information** settings are informational only: IP Precedence and Mapping to Queue.

The ensuing table for **Queue Mapping Information** settings are informational only: Queue and Mapping to IP Precedence.

4.8.2 QoS Basic Mode

Quality of Service (QoS) allows to give preferential treatment to certain types of traffic at the expense of others. Without QoS, the switch offers best-effort service to each packet, regardless of the packet contents or size sending the packets without any assurance of reliability, delay bounds, or throughput.

QoS mode supports two modes: 802.1p and DSCP.

4.8.2.1 Global Settings

The Global Settings page allows you to configure the trust mode to a port selection.

To access this page, click **QoS > QoS Basic Mode > Global Settings**.

The function is only available when **QoS Properties** is set to **Basic**.

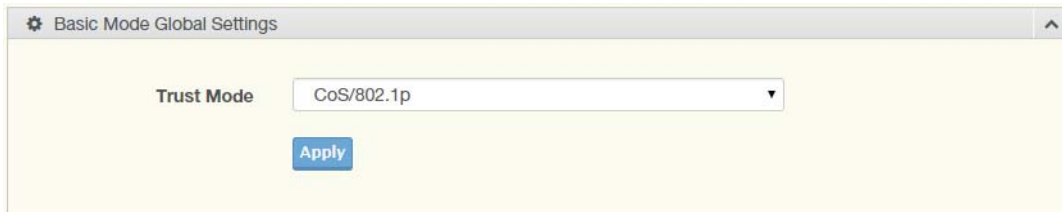

Figure 4.96 QoS > QoS Basic Mode > Global Settings

The following table describes the items in the previous figure.

Item	Description
Trust Mode	Click the drop-down menu to select the trust state of the QoS basic mode.
Apply	Click Apply to save the values and update the screen.

The ensuing table for **QoS Information** settings are informational only: Trust Mode.

4.8.2.2 Port Settings

The Port Settings page allows you to define a trust state (enabled or disabled) to a listed port.

To access this page, click **QoS > QoS Basic Mode > Port Settings**.



Figure 4.97 QoS > QoS Basic Mode > Port Settings

The following table describes the items in the previous figure.

Item	Description
Port	Enter the port number for the QoS basic mode setting.
Trust State	Select Enabled or Disabled to set the port's trust state status.
Apply	Click Apply to save the values and update the screen.

The ensuing table for **QoS Port Status** settings are informational only: Port and Trust State.

4.8.3 Rate Limit

Rate Limits features control on a per port basis. Bandwidth control is supported for the following: Ingress Bandwidth Control, Egress Bandwidth Control and Egress Queue.

4.8.3.1 Ingress Bandwidth Control

The Ingress Bandwidth Control page allows you to configure the bandwidth control for a listed port.

To access this page, click **QoS > Rate Limit > Ingress Bandwidth Control**.

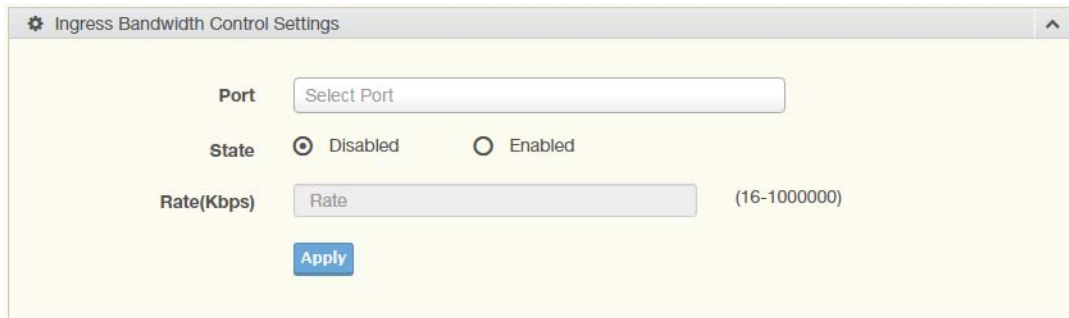

Figure 4.98 QoS > Rate Limit > Ingress Bandwidth Control

The following table describes the items in the previous figure.

Item	Description
Port	Enter the port number for the rate limit setup.
State	Select Disabled or Enabled to set the port's state status.
Rate (Kbps)	Enter the value in Kbps (16 to 1000000) to set as the bandwidth rate for the selected port.
Apply	Click Apply to save the values and update the screen.

The ensuing table for **Ingress Bandwidth Control Status** settings are informational only: Port and Ingress Rate Limit (Kbps).

4.8.3.2 Egress Bandwidth Control

The Egress Bandwidth Control page allows you to set the egress bandwidth control for a listed port.

To access this page, click **QoS > Rate Limit > Egress Bandwidth Control**.

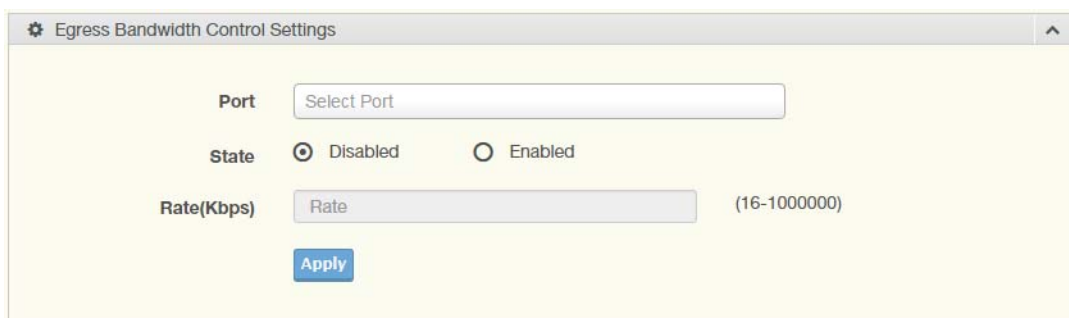

Figure 4.99 QoS > Rate Limit > Egress Bandwidth Control

The following table describes the items in the previous figure.

Item	Description
Port	Enter the port number to set the Egress Bandwidth Control.

Item	Description
State	Select Disabled or Enabled to set the Egress Bandwidth Control state.
Rate (Kbps)	Enter the value in Kbps (16 to 1000000) to set the Egress Bandwidth rate.
Apply	Click Apply to save the values and update the screen.

The ensuing table for **Egress Bandwidth Control Status** settings are informational only: Port and Egress Rate Limit (Kbps).

4.8.3.3 Egress Queue

The Egress Queue page allows you to set the egress bandwidth parameters.

To access this page, click **QoS > Rate Limit > Egress Queue**.

Figure 4.100 QoS > Rate Limit > Egress Queue

The following table describes the items in the previous figure.

Item	Description
Port	Click the drop-down menu to select the port to define the Egress queue.
Queue	Click the drop-down menu to set the queue order for the Egress setting.
State	Click Disabled or Enabled to set the Egress queue state.
CIR (Kbps)	Enter the value in Kbps (16 to 1000000) to set the CIR rate for the Egress queue.
Apply	Click Apply to save the values and update the screen.

The ensuing table for **FE1 Egress Per Queue Status** settings are informational only: Queue Id and Egress Rate Limit (Kbps).

4.8.4 Bandwidth Guarantee

4.8.4.1 Global Settings

To access this page, click **QoS > Bandwidth Guarantee > Global Settings**.

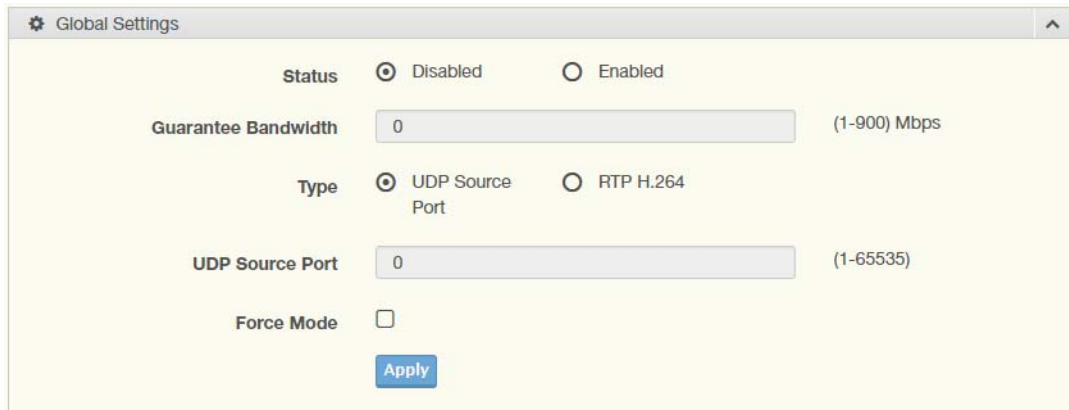

The screenshot shows the 'Global Settings' configuration page. At the top, there is a gear icon and the title 'Global Settings'. Below this, the 'Status' is set to 'Disabled' with a radio button. The 'Guarantee Bandwidth' is set to '0' in a text input field, with a range of '(1-900) Mbps' indicated to the right. The 'Type' is set to 'UDP Source Port' with a radio button. The 'UDP Source Port' is set to '0' in a text input field, with a range of '(1-65535)' indicated to the right. The 'Force Mode' checkbox is unchecked. At the bottom, there is a blue 'Apply' button.

Figure 4.101 QoS > Bandwidth Guarantee > Global Settings

The following table describes the items in the previous figure.

Item	Description
Status	Click Disabled or Enabled to set the guarantee bandwidth.
Guarantee Bandwidth	Enter the value for the guarantee bandwidth.
Type	Click UDP Source Port or RTP H.264 to set the guarantee bandwidth type.
UDP Source Port	Enter the port number for the UDP source.
Force Mode	Click the check box to enable the force mode.
Apply	Click Apply to save the values and update the screen.

The ensuing table for **Ingress Bandwidth Control Status** settings are informational only: Status, Guarantee Bandwidth, Guarantee Type, UDP Source Port and Force Mode.

4.8.4.2 Utilization

To access this page, click **QoS > Bandwidth Guarantee > Utilization**.

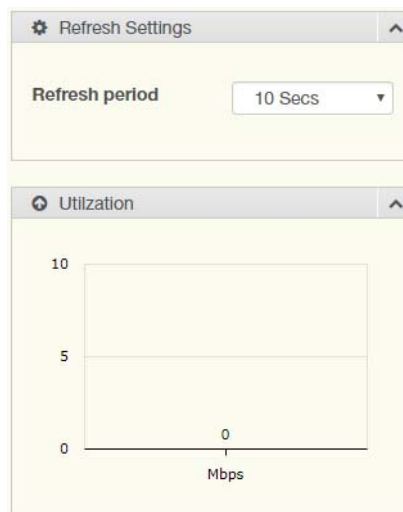

Figure 4.102 QoS > Bandwidth Guarantee > Utilization

The following table describes the items in the previous figure.

Item	Description
Refresh period	Click the drop-down menu to select refresh time.
Apply	Click Apply to save the values and update the screen.

4.9 Management

4.9.1 LLDP

LLDP is a one-way protocol without request/response sequences. Information is advertised by stations implementing the transmit function, and is received and processed by stations implementing the receive function.

4.9.1.1 LLDP System Settings

The LLDP System Settings allows you to configure the status (enabled or disabled) for the protocol, set the interval for frame transmission, set the hold time multiplier and the re-initialization delay.

To access this page, click **Management > LLDP > LLDP System Settings**.

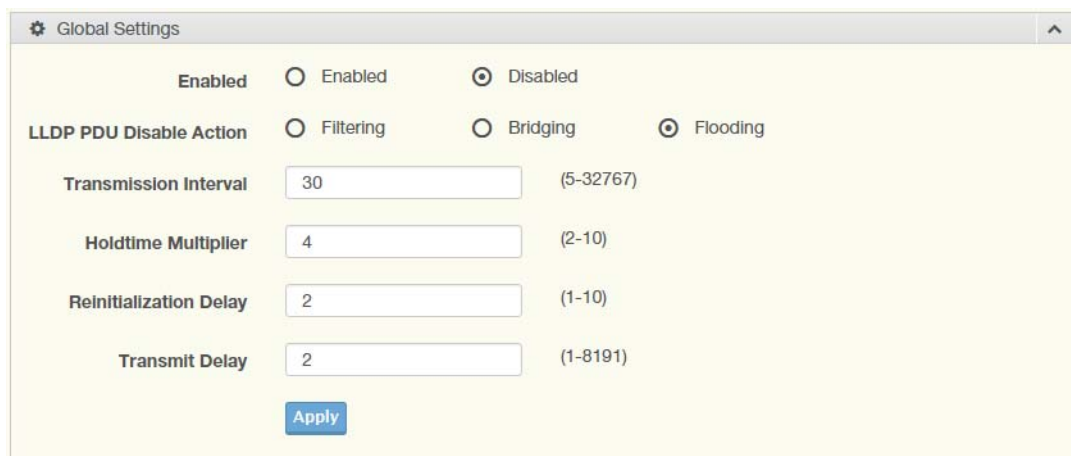

Figure 4.103 Management > LLDP > LLDP System Settings

The following table describes the items in the previous figure.

Item	Description
Enabled	Click Enabled or Disabled to set the Global Settings state.
LLDP PDU Disable Action	Click to select the LLDP PDU handling action when LLDP is globally disabled. Options include: Filtered, Bridged, or Flooded.
Transmission Interval	Select the interval at which frames are transmitted. The default is 30 seconds, and the valid range is 5 to 32768 seconds.
Holdtime Multiplier	Select the multiplier on the transmit interval to assign to TTL.
Reinitialization Delay	Select the delay length before re-initialization.
Transmit Delay	Select the delay after an LLDP frame is sent.
Apply	Click Apply to save the values and update the screen.

The ensuing table for **LLDP Global Config** settings are informational only: LLDP Enabled, LLDP PDU Disable Action, Transmission Interval, Holdtime Multiplier, Reinitialization Delay and Transmit Delay.

4.9.1.2 LLDP Port Settings

The LLDP Port Settings page allows you to configure the state (enabled or disabled) of the selected port.

To access this page, click **Management > LLDP > LLDP Port Settings**.



Figure 4.104 Management > LLDP > LLDP Port Settings > LLDP Port Configuration

The following table describes the items in the previous figure.

Item	Description
Port Select	Enter the port number associated with the LLDP setting.
State	Click the drop-down menu to select the LLDP port state.
Apply	Click Apply to save the values and update the screen.



Figure 4.105 Management > LLDP > LLDP Port Settings > Optional TLVs Selection

The following table describes the items in the previous figure.

Item	Description
Port Select	Enter the port number associated with the TLV (optional) selection.
Optional TLV Select	Click the drop-down menu to select the LLDP optional TLVs to be carried (multiple selections are allowed). <ul style="list-style-type: none">■ System Name: To include system name TLV in LLDP frames.■ Port Description: To include port description TLV in LLDP frames.■ System Description: To include system description TLV in LLDP frames.■ System Capability: To include system capability TLV in LLDP frames.■ 802.3 MAC-PHY:■ 802.3 Link Aggregation:■ 802.3 Maximum Frame Size:■ Management Address:■ 802.1 PVID:
Apply	Click Apply to save the values and update the screen.

The ensuing table for **LLDP Port Status** settings are informational only: Port, State and Selected Optional TLVs.

Figure 4.106 Management > LLDP > LLDP Port Settings > VLAN Name TLV VLAN Selection

The following table describes the items in the previous figure.

Item	Description
Port Select	Enter the port number to associated with the TLV selection.
VLAN Select	Select the VLAN Name ID to be carried out (multiple selection is allowed).
Apply	Click Apply to save the values and update the screen.

The ensuing table for **LLDP Port VLAN TLV Status** settings are informational only: Port and Selected VLAN.

4.9.1.3 LLDP Local Device Info

The LLDP Local Device Info page allows you to view information regarding network devices, providing that the switch has already obtained LLDP information on the devices.

To access this page, click **Management > LLDP > LLDP Local Device Info**.

The ensuing table for **Local Device Summary** settings are informational only: Chassis ID Subtype, Chassis ID, System Name, System Description, Capabilities Supported, Capabilities Enabled and Port ID Subtype.

The ensuing table for **Port Status** settings are informational only: Port, Selected VLAN and **Detail** (click the radio box and click **Detail** to displays the details).

4.9.1.4 LLDP Remote Device Info

The LLDP Remote Device Info page allows you to view information about remote devices, LLDP information must be available on the switch.

To access this page, click **Management > LLDP > LLDP Remote Device Info**.

Figure 4.107 Management > LLDP > LLDP Remote Device Info

The following table describes the items in the previous figure.

Item	Description
Detail	Click to display the device details.
Delete	Click to delete the selected devices.
Refresh	Click to refresh the remote device information list.

4.9.1.5 LLDP Overloading

To access this page, click **Management > LLDP > LLDP Overloading**.

The ensuing table for **LLDP Overloading** settings are informational only: Port, Total (Bytes), Left to Send (Bytes), Status and Status (Mandatory TLVs, 802.3 TLVs, Optional TLVs and 802.1 TLVs).

4.9.2 SNMP

Simple Network Management Protocol (SNMP) is a protocol to facilitate the monitoring and exchange of management information between network devices. Through SNMP, the health of the network or status of a particular device can be determined.

4.9.2.1 SNMP Settings

The SNMP Settings page allows you to set the SNMP daemon state (enabled or disabled).

To access this page, click **Management > SNMP > SNMP Settings**.

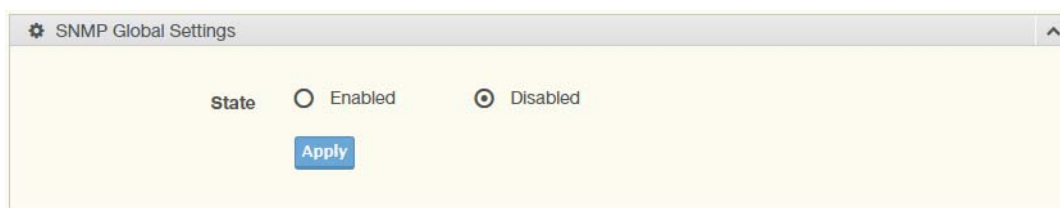

Figure 4.108 Management > SNMP > SNMP Settings

The following table describes the items in the previous figure.

Item	Description
State	Click Enabled or Disabled to define the SNMP daemon.
Apply	Click Apply to save the values and update the screen.

The ensuing table for **SNMP Information** settings are informational only: SNMP.

4.9.2.2 SNMP Community

The SNMP Community page provides configuration options for the community.

SNMP v1 and SNMP v2c use the group name (Community Name) certification. It's role is similar to the password function. If SNMP v1 and SNMP v2c are used, you can go directly from the configuration settings to this page to configure the SNMP community.

To access this page, click **Management > SNMP > SNMP Community**.



Figure 4.109 Management > SNMP > SNMP Community

The following table describes the items in the previous figure.

Item	Description
Community Name	Enter a community name (up to 20 characters).

Item	Description
Access Right	Click the radio box to specify the access level (read only or read write)
Apply	Click Apply to save the values and update the screen.

The ensuing table for **Community Status** settings are informational only: No., Community Name, Access Right and **Delete** (click to delete the desired community name).

4.9.2.3 SNMPv3 EngineID

To access this page, click **Management > SNMP > SNMPv3 EngineID**.

Figure 4.110 Management > SNMP > SNMPv3 EngineID

The following table describes the items in the previous figure.

Item	Description
SNMP EngineID	Enter the hexadecimal string to define the engine ID for SNMPv3 agent.

4.9.2.4 SNMPv3 Settings

The SNMPv3 Settings page allows you to create SNMP groups. The users have the same level of security and access control permissions as defined by the group settings.

To access this page, click **Management > SNMP > SNMPv3 Settings**.

Figure 4.111 Management > SNMP > SNMPv3 Settings

The following table describes the items in the previous figure.

Item	Description
User Name	Enter a user name (up to 32 characters) to create an SNMP profile.
Access Right	Click read-only or read-write to define the access right for the profile.
Encrypted	Click the option to set the encrypted option for the user setting.

Item	Description
Auth-Protocol	Click the drop-down menu to select the authentication level: MD5 or SHA. The field requires a user password. <ul style="list-style-type: none"> ■ MD5: specify HMAC-MD5-96 authentication level ■ SHA: specify HMAC-SHA authentication protocol
Password	Enter the characters to define the password associated with the authentication protocol.
Priv-Protocol	Click the drop-down menu to select an authorization protocol: none or DES. The field requires a user password. <ul style="list-style-type: none"> ■ None: no authorization protocol in use ■ DES: specify 56-bit encryption in use
Password	Enter the characters to define the password associated with the authorization protocol.
Add	Click Add to save the values and update the screen.

The ensuing table for **User Status** settings are informational only: User Name, Access Right, Auth-Protocol, Priv-Protocol and **Delete** (click to delete the desired user name).

4.9.2.5 SNMP Trap

The SNMP Trap page allows you to set the IP address of the node and the SNMP credentials corresponding to the version that is included in the trap message.

To access this page, click **Management > SNMP > SNMP Trap**.

Figure 4.112 Management > SNMP > SNMP Trap

The following table describes the items in the previous figure.

Item	Description
IP Address	Enter the IP address to designate the SNMP trap host.
Community Name/ User Name	Click the drop-down menu to select a defined community name.
Version	Click the drop-down menu to designate the SNMP version credentials (v1, v2c - trap, v2c - inform, v2c - trap or v2c - inform).
Add	Click Add to save the values and update the screen.

The ensuing table for **Trap Host Status** settings are informational only: No., IP Address, Community Name, Version and **Delete** (click to delete the desired IP address).

4.9.3 Power Over Ethernet

Power Over Ethernet is the function supplying power to Powered Devices (PD) through the switch in the event that AC power is not readily available.

Power over Ethernet can be used for the following areas:

- Surveillance devices
- I/O sensors for security requirements
- Wireless access points

Series	Supported Models
EKI	7712G-4FP, 7712G-4FPI

4.9.3.1 PoE System Settings

The PoE System Settings page allows you to configure the overload disconnect and the maximum available wattage.

To access this page, click **Management > Power Over Ethernet > PoE System Settings**.



Figure 4.113 Management > Power Over Ethernet > PoE System Settings

The following table describes the items in the previous figure.

Item	Description
Maximum Power Available	Select the value in Watts to set the maximum available power.
OverLoad Disconnect Mode	Click the drop-down menu to designate the overload mode: <ul style="list-style-type: none"> ■ Overload Port First: ■ Port-Based Priority:
Apply	Click Apply to save the values and update the screen.

The ensuing table for **PoE System Information** settings are informational only: Firmware Version, Maximum Power Available, Actual Power Consumption and Overload Disconnect Type.

4.9.3.2 PoE Port Settings

The PoE Port Settings page allows you to configure the port status, its power limitations, legacy mode status, and power limit settings.

To access this page, click **Management > Power Over Ethernet > PoE Port Settings**.

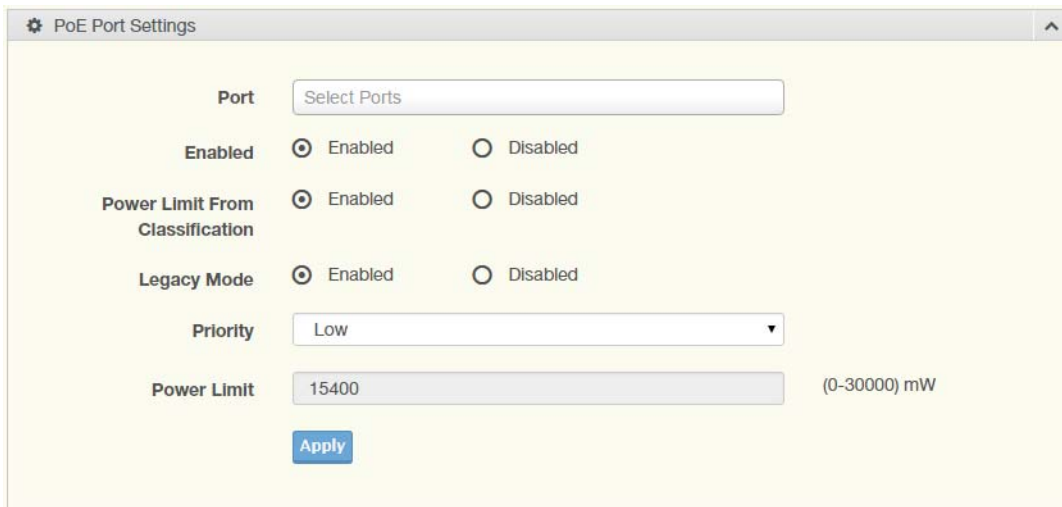

Figure 4.114 Management > Power Over Ethernet > PoE Port Settings

The following table describes the items in the previous figure.

Item	Description
Port	Click the drop-down menu to select a PoE port.
Enabled	Select Enabled or Disabled to designate the PoE port function by ports.
Power Limit From Classification	Select Enabled or Disabled to designate the power limit classification.
Legacy Mode	Select Enabled or Disabled to designate the legacy mode option for the port.
Priority	Click the drop-down menu to configure the power supply priority: Critical , Low , Medium or High . Default is Low .
Power Limit	Enter a number to set the port power current limitation to be given to the Powered Device (PD)
Apply	Click Apply to save the values and update the screen.

The ensuing table for **PoE Information** settings are informational only: Port, Enable State, Power Limit From Classification, Priority, Legacy and Power Limit (W).

4.9.3.3 PoE Port Status

To access this page, click **Management > Power Over Ethernet > PoE Port Status**.

The ensuing table for **PoE Port Status** settings are informational only: Port, Current (mA), Voltage (V), Power (W) and Temp. (°C).

4.9.4 TCP Modbus Settings

The TCP Modbus function allows for client-server communication between a switch module (server) and a device in the networking running MODBUS client software (client).

4.9.4.1 TCP Modbus Settings

The TCP Modbus Settings page allows you to configure the modbus function.

To access this page, click **Management > TCP Modbus Settings > TCP Modbus Settings**.

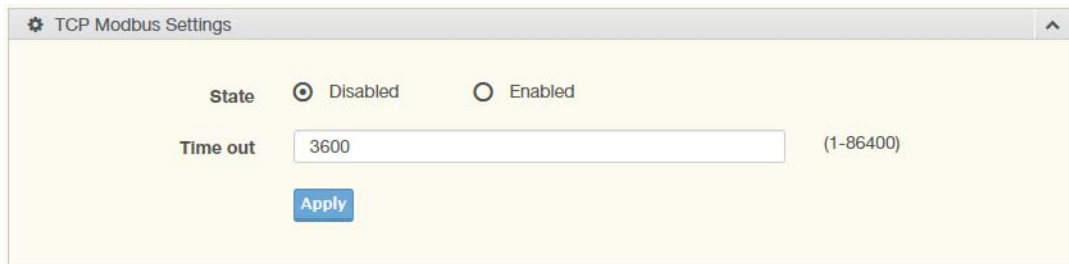

Figure 4.115 Management > TCP Modbus Settings > TCP Modbus Settings

The following table describes the items in the previous figure.

Item	Description
State	Click Disabled or Enabled to set the TCP Modbus state.
Time out	Enter the value (1 to 86400) to define the timeout period between transport time.
Apply	Click Apply to save the values and update the screen.

The ensuing table for **TCP Modbus Status** settings are informational only: TCP Modbus status and TCP Modbus time out.

4.9.5 DHCP Server

The Dynamic Host Configuration Protocol (DHCP) is a network protocol enabling a server to automatically assign an IP address to a computer from a defined range of numbers configured for a given network.

4.9.5.1 Status Settings

The Status Settings page allows you to configure the DHCP server mode (enabled or disabled).

To access this page, click **Management > DHCP Server > Status Settings**.



Figure 4.116 Management > DHCP Server > Status Settings

The following table describes the items in the previous figure.

Item	Description
DHCP Server	Select Enable or Disable to designate the DHCP server function type. When a new DHCP server mode is selected, the switch requires a system restart for the new mode to take effect.
Apply	Click Apply to save the values and update the screen.
Restart	Click Restart to have the switch perform a system restart function. In the event that the IP settings are changed, the DHCP server must be restarted for the IP settings to take effect.

The ensuing table for **Status Information** settings are informational only: DHCP Server Service.

4.9.5.2 Global Settings

The Global Settings page allows you to configure the global settings for the DHCP function.

To access this page, click **Management > DHCP Server > Global Settings**.

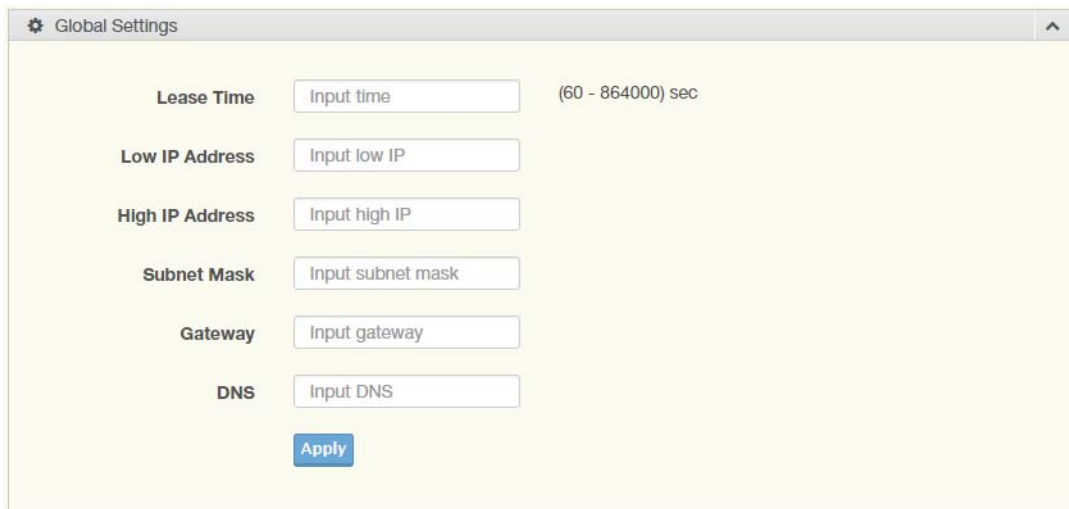

Figure 4.117 Management > DHCP Server > Global Settings

The following table describes the items in the previous figure.

Item	Description
Lease Time	Type in the value designating the lease time (60 - 864000) in seconds for each setting lease.
Low IP Address	Type in the value designating the lowest range in the IP address pool.
High IP Address	Type in the value designating the highest range in the IP address pool.
Subnet Mask	Type in the value designating the subnet mask for the IP address pool.
Gateway	Type in the value designating the gateway for the IP address pool.
DNS	Type in the value designating the DNS for the IP address pool.
Apply	Click Apply to save the values and update the screen.

The ensuing table for **Global Information** settings are informational only: Lease Time, Low IP Address, High IP Address, Subnet Mask, Gateway, DNS and **Clear** (click to clear IP pool).

4.9.5.3 Port Settings

The Port Settings page allows you to configure selected ports for the DHCP function. To access this page, click **Management > DHCP Server > Port Settings**.

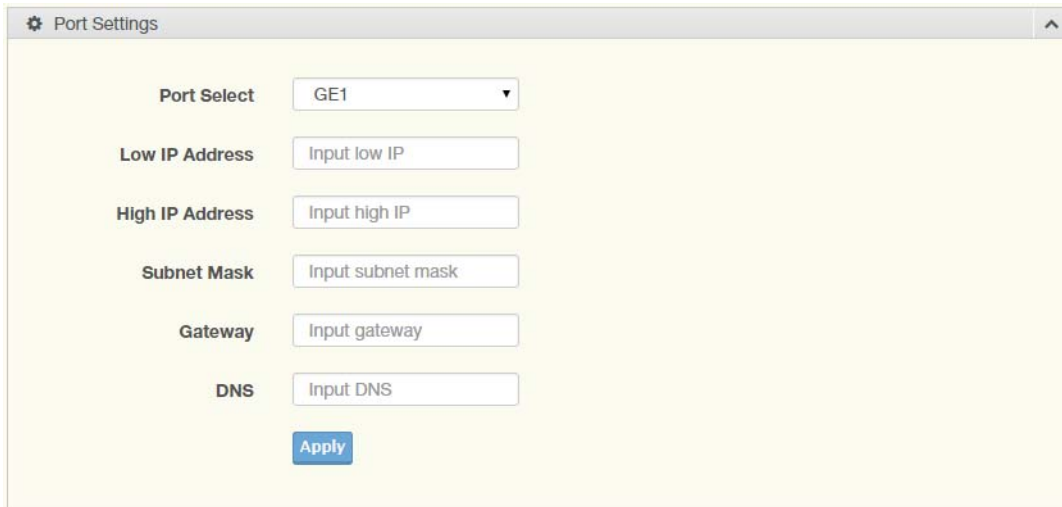

Figure 4.118 Management > DHCP Server > Port Settings

The following table describes the items in the previous figure.

Item	Description
Port Select	Click the drop-down menu to select a pre-defined port to configure. The suboptions are designated for the selected port.
Low IP Address	Type in the value designating the lowest range in the IP address pool.
High IP Address	Type in the value designating the highest range in the IP address pool.
Subnet Mask	Type in the value designating the subnet mask for the IP address pool.
Gateway	Type in the value designating the gateway for the IP address pool.
DNS	Type in the value designating the DNS for the IP address pool.
Apply	Click Apply to save the values and update the screen.

The ensuing table for **Port Information** settings are informational only: Port, Low IP Address, High IP Address, Subnet Mask, Gateway, DNS, **Edit** (click to modify the settings) and **Clear** (click to clear the settings).

4.9.5.4 VLAN Settings

The VLAN Settings page allows you to configure selected ports for the VLAN function.

To access this page, click **Management > DHCP Server > VLAN Settings**.

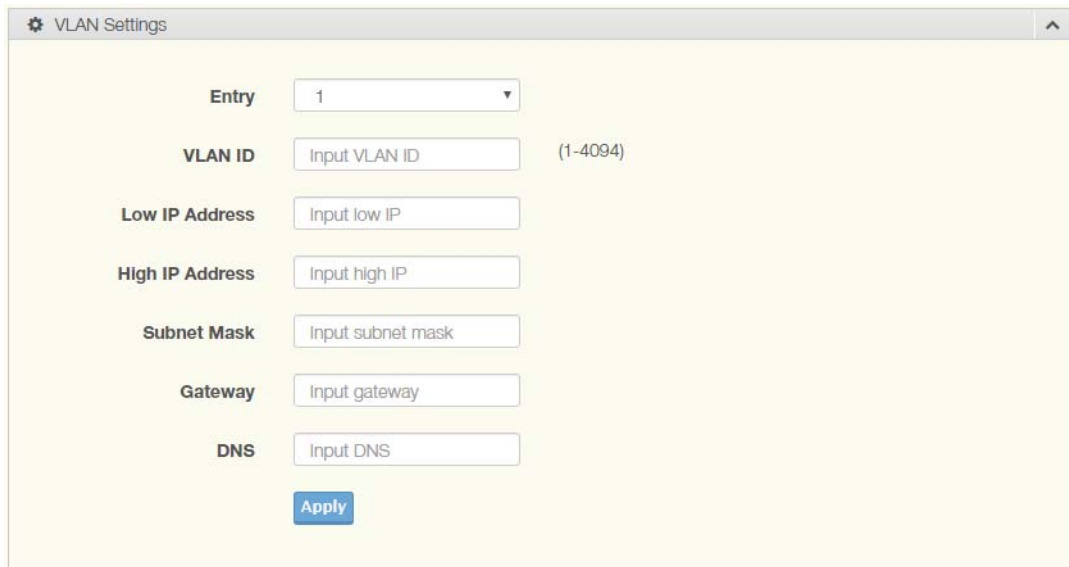

Figure 4.119 Management > DHCP Server > VLAN Settings

The following table describes the items in the previous figure.

Item	Description
Entry	Click the drop-down menu to select a pre-defined port to configure.
VLAN ID	Type in the value to use as an identifier for the VLAN (1 to 4094).
Low IP Address	Type in the value designating the lowest range in the IP address pool.
High IP Address	Type in the value designating the highest range in the IP address pool.
Subnet Mask	Type in the value designating the subnet mask for the IP address pool.
Gateway	Type in the value designating the gateway for the IP address pool.
DNS	Type in the value designating the DNS for the IP address pool.
Apply	Click Apply to save the values and update the screen.

The ensuing table for **Entry Information** settings are informational only: Entry ID, VLAN ID, Low IP Address, High IP Address, Subnet Mask, Gateway, DNS, **Edit** (click to modify the settings) and **Clear** (click to clear the settings).

4.9.5.5 Option 82 Settings

The Option 82 Settings, also known as the DHCP relay agent information option, provide information about the network location of a DHCP client. In turn, the DHCP server uses the information to implement IP addresses or other parameters for the client.

To access this page, click **Management > DHCP Server > Option 82 Settings**.

Figure 4.120 Management > DHCP Server > Option 82 Settings

The following table describes the items in the previous figure.

Item	Description
Entry	Click the drop-down menu to select an entry for the Option 82 setting.
Circuit ID Format	Click the drop-down menu to select the format of the circuit ID: string or hex.
Circuit ID Content	Enter the circuit ID string on the switch on which the request was received.
Remote ID Format	Click the drop-down menu to select the format of the remote ID: string or hex.
Remote ID Content	Enter the remote ID string of the host.
Low IP Address	Type in the value designating the lowest range in the IP address pool.
High IP Address	Type in the value designating the highest range in the IP address pool.
Subnet Mask	Type in the value designating the subnet mask for the IP address pool.
Gateway	Type in the value designating the gateway for the IP address pool.
DNS	Type in the value designating the DNS for the IP address pool.
Apply	Click Apply to save the values and update the screen.

The ensuing table for **Entry Information** settings are informational only: **Entry** (click the drop-down menu to select an entry), Entry ID, Circuit ID Format, Circuit ID Content, Remote ID Format, Remote ID Content, Low IP Address, High IP Address, Subnet Mask, Gateway, DNS, **Edit** (click to modify the settings) and **Clear** (click to clear the settings).

4.9.5.6 Client MAC Settings

To access this page, click **Management > DHCP Server > Client MAC Settings**.

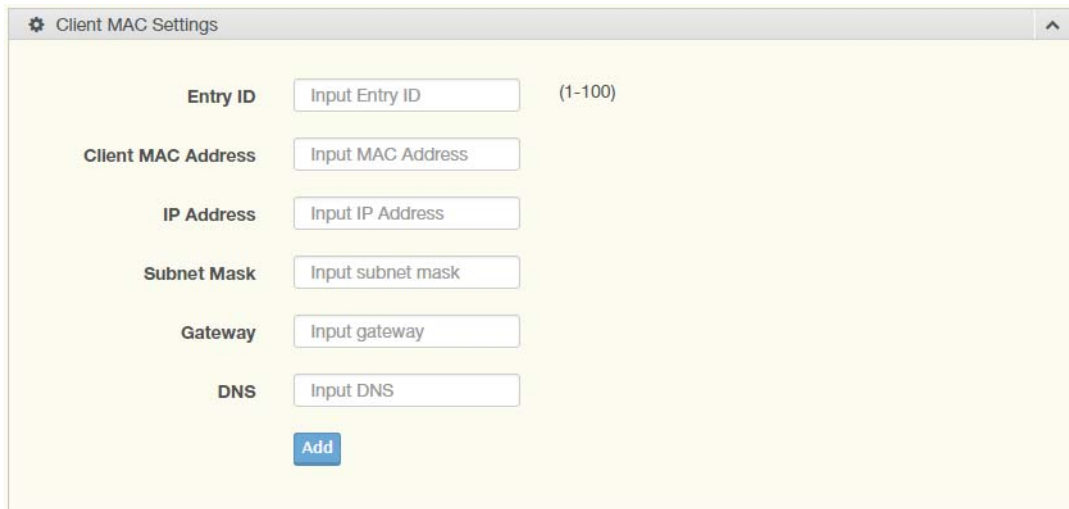

Figure 4.121 Management > DHCP Server > Client MAC Settings

The following table describes the items in the previous figure.

Item	Description
Entry ID	Type in the value designating the entry ID.
Client MAC Address	Enter the MAC address for DHCP server.
IP Address	Enter a value to specify the IP address of the interface.
Subnet Mask	Enter a value to specify the IP subnet mask for the interface.
Gateway	Enter a value to specify the gateway for the interface.
DNS	Enter a value to specify the DNS server for the interface.
Apply	Click Apply to save the values and update the screen.

The ensuing table for **Client MAC Information** settings are informational only: Entry ID, Client MAC Address, IP Address, Subnet Mask and Modify (Click **Detail** to display the detail information of desired entry id or **Delete** to delete the desired entry id).

4.9.5.7 Lease Entry

To access this page, click **Management > DHCP Server > Lease Entry**.

The ensuing table for **Lease entry Table** settings are informational only: IP Address, Client Mac, Start Time, End Time and Type.

4.9.6 SMTP Client

Simple Mail Transfer Protocol (SMTP) is a protocol to send e-mail messages between servers. SMTP is used to send messages from a mail client to a mail server. SMTP by default uses TCP port 25.

4.9.6.1 Global Settings

The Global Settings page allows you to set the active profile for the SMTP client.

To access this page, click **Management > SMTP Client > Global Settings**.



Figure 4.122 Management > SMTP Client > Global Settings

The following table describes the items in the previous figure.

Item	Description
Active Profile	Click the drop-down menu to select the profile status (None, 1 or 2).
Apply	Click Apply to save the values and update the screen.

The ensuing table for **SMTP Information** settings are informational only: Active Profile Id.

4.9.6.2 Profile Settings

The Profile Settings page allows you to select the server IP, the server port, and sender mail for the listed profile.

To access this page, click **Management > SMTP Client > Profile Settings**.



Figure 4.123 Management > SMTP Client > Profile Settings > Profile Settings

The following table describes the items in the previous figure.

Item	Description
Profile ID	Click the drop-down menu to select the identification type for the profile (1 or 2).
Server IP	Enter the IP address to designate the server host.
Server Port	Enter the port number to designate the port associated with the server IP address.
Sender Mail	Enter the email address of the sender client.
Apply	Click Apply to save the values and update the screen.

Figure 4.124 Management > SMTP Client > Profile Settings > Profile Target Mail Settings

The following table describes the items in the previous figure.

Item	Description
Profile ID	Click the drop-down menu to select the identification type for the profile (1 or 2).
Target Mail	Enter the email address of the target client.
Apply	Click Apply to save the values and update the screen.

The ensuing table for **Profile Information** settings are informational only: **Profile ID** (click the drop-down menu to select a profile ID), Server IP, Server Port and Sender Mail Address.

4.9.6.3 Sending Message

The Sending Message page allows you to setup the log message for use with the SMTP client.

To access this page, click **Management > SMTP Client > Sending Message**.

Figure 4.125 Management > SMTP Client > Sending Message

The following table describes the items in the previous figure.

Item	Description
Title	Assign the title of the email. The maximum length is 20 characters (alphanumeric, symbols (. (dot), _ (underline), - (dash line) and space).

Item	Description
Content	Assign the content of the email. The maximum length is 64 characters (alphanumeric, symbols (. (dot), _ (underline), - (dash line) and space).
Apply	Click Apply to save the values and update the screen.

4.9.7 RMON

Remote monitoring (RMON) uses a client-server model to monitor/manage remote devices on a network.

4.9.7.1 RMON Statistics

The RMON Statistics page allows you to view information regarding packet sizes and information for physical layer errors. The information displayed is according to the RMON standard.

To access this page, click **Management > RMON > RMON Statistics**.

Figure 4.126 Management > RMON > Rmon Statistics

The following table describes the items in the previous figure.

Item	Description
Index	Enter an entry selection (1 to 65535) to display its statistical information.
Port	Enter the respective port number for the selected entry.
Owner	Enter the name of the owner of the RMON group.
Apply	Click Apply to save the values and update the screen.

The ensuing table for **Statistics Information** settings are informational only: Index, Port, Drop Events, Octets, Packets, Broadcast, Multicast, Owner and **Delete** (click to delete the desired index).

4.9.7.2 RMON History

The RMON History page allows you to configure the display of history entries. To access this page, click **Management > RMON > RMON History**.

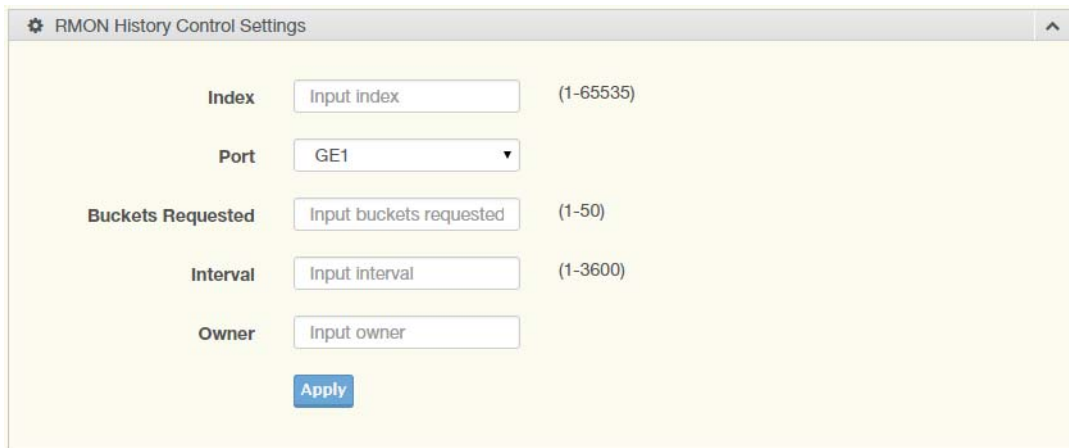

Figure 4.127 Management > RMON > RMON History

The following table describes the items in the previous figure.

Item	Description
Index	Enter the index entry (1 to 65535) to select the number of new history table entries.
Port	Select the specific port switch.
Buckets Requested	Enter the specific (1-50) number of samples to store.
Interval	Enter value in seconds (1 to 3600) to designate a specific interval time for the collection of samples.
Owner	Enter the name of the owner of the RMON history group.
Apply	Click Apply to save the values and update the screen.

The ensuing table for **History Information** settings are informational only: Index, Port, Buckets Requested, Interval, Owner and **Delete** (click to delete the desired index).

4.9.7.3 RMON Alarm

The RMON Alarm page allows you to configure RMON statistics group and alarm groups.

To access this page, click **Management > RMON > RMON Alarm**.

Figure 4.128 Management > RMON > Rmon Alarm

The following table describes the items in the previous figure.

Item	Description
Index	Enter the index entry (1 to 65535) to define a specific Alarm Collection history entry.
Interval	Enter a value (1 to 2147483647) to define the interval value for the Alarm Collection history.
Variable	Enter the alarm variables to define the monitoring triggers.
Sample Type	Enter the variable sample type.
Rising Threshold	Enter the rising alarm threshold trigger.
Falling Threshold	Enter the falling alarm threshold trigger.
Rising Event Index	Enter the rising event index (1-65535) to define the alarm group.
Falling Event Index	Enter the falling event index (1-65535) to define the alarm group.
Owner	Enter the name of the owner of the RMON alarm group.
Apply	Click Apply to save the values and update the screen.

The ensuing table for **Alarm Information** settings are informational only: Index, Interval, Variable, Sample Type, Rising Threshold, Falling Threshold, Rising Event Index, Falling Event Index, Owner and **Delete** (click to delete the desired index).

4.9.7.4 RMON Event

The RMON Event page is used to configure RMON event groups.
To access this page, click **Management > RMON > RMON Event**.

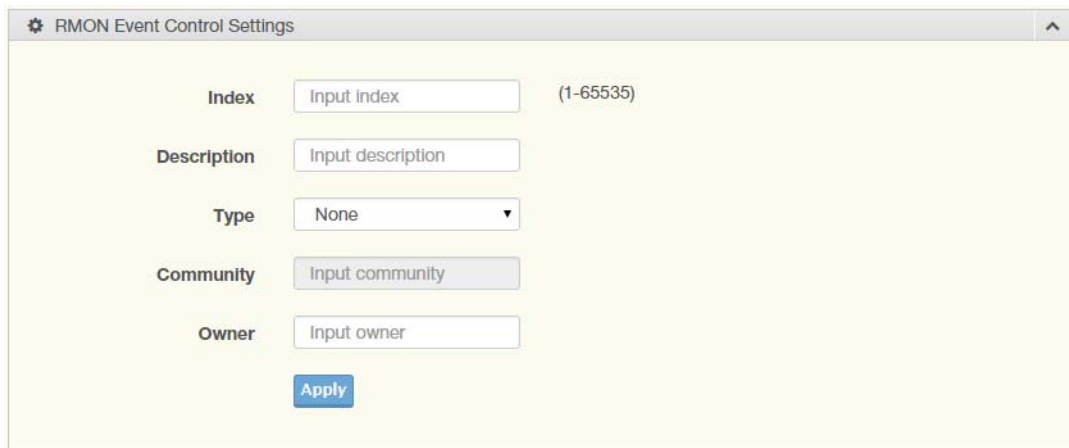

Figure 4.129 Management > RMON > RMON Event

The following table describes the items in the previous figure.

Item	Description
Index	Enter the index entry (1 to 65535) to define a specific RMON event.
Description	Enter a value (1 to 2147483647) to define the interval value for the Alarm Collection history.
Type	Click the drop-down menu to define the event type: None, Log, SNMP Trap, Log and Trap.
Community	Enter the community string to be passed for the specified event.
Owner	Enter the name of the owner of the RMON event.
Apply	Click Apply to save the values and update the screen.

The ensuing table for **Event Information** settings are informational only: Index, Description, Type, Community, Owner and **Delete** (click to delete the desired index).

4.9.8 NTP Server

To access this page, click **Management > NTP Server**.

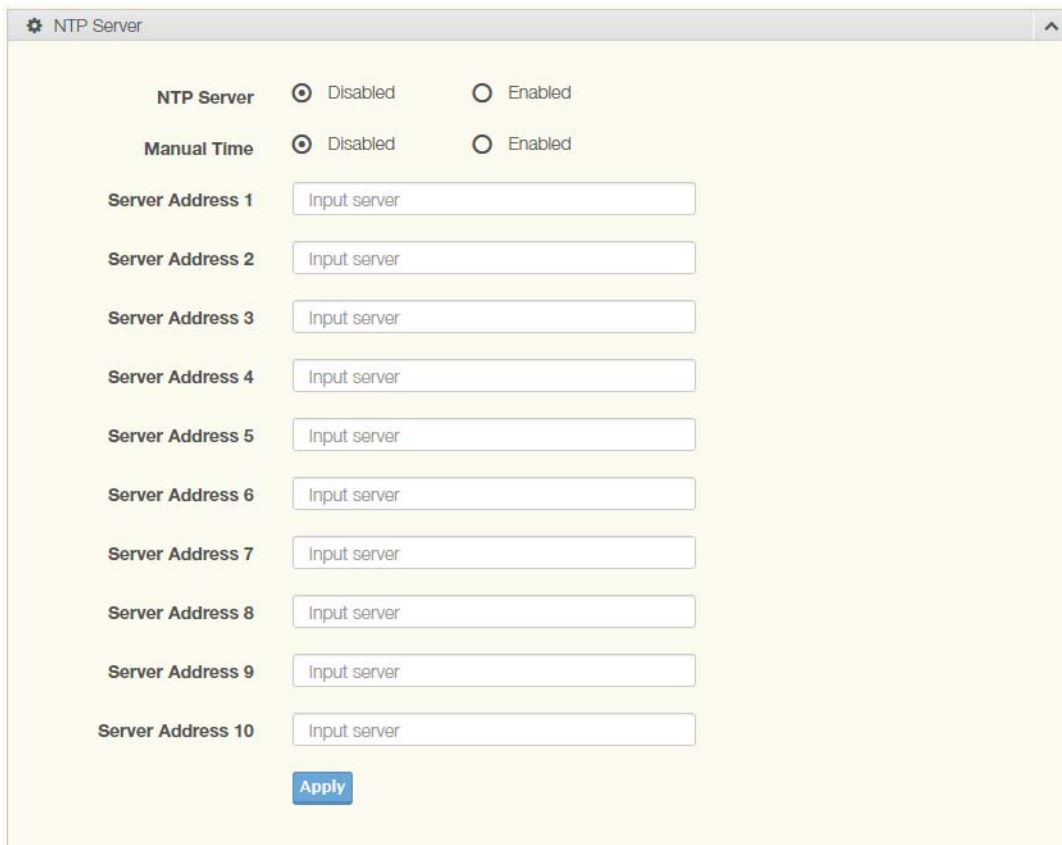

Figure 4.130 Management > NTP Server

The following table describes the items in the previous figure.

Item	Description
NTP Server	Click the radio button to enable or disable the NTP server function.
Manual Time	Click the radio button to enable or disable the manual time function.
Server Address 1 ~ Server Address 10	Enter the address of the NTP server. This is a text string of up to 64 characters containing the encoded unicast IP address or hostname of a NTP server.
Apply	Click Apply to save the values and update the screen.

The ensuing table for **NTP Server Status** settings are informational only: INTP Server Status, Manual Time, Server Address Information Value, Server 1, Server 2, Server 3, Server 4, Server 5, Server 6, Server 7, Server 8, Server 9 and Server 10.

4.10 Diagnostics

Through the Diagnostics function configuration of settings for the switch diagnostics is available.

4.10.1 Cable Diagnostics

The Cable Diagnostics page allows you to select the port for applying a copper test. To access this page, click **Diagnostics > Cable Diagnostics**.



Figure 4.131 Diagnostics > Cable Diagnostics

The following table describes the items in the previous figure.

Item	Description
Port	Click the drop-down menu to select a pre-defined port for diagnostic testing. Giga ports are displayed with a channel A to D designation.
Copper Test	Click Copper Test to display the test result for the selected port.

The ensuing table for **Test Result** settings are informational only: Port, Channel A, Cable Length A, Channel B, Cable Length B, Channel C, Cable Length C, Channel D and Cable Length D.

4.10.2 Ping Test

The Ping Test page allows you to configure the test log page.

To access this page, click **Diagnostics > Ping Test**.

The screenshot shows a web interface for configuring a ping test. It includes a title bar, four input fields with labels and hints, a results display area, and an 'Apply' button.

Figure 4.132 Diagnostics > Ping Test

The following table describes the items in the previous figure.

Item	Description
IP Address	Enter the IP address or host name of the station to ping. The initial value is blank. The IP Address or host name you enter is not retained across a power cycle. Host names are composed of series of labels concatenated with periods. Each label must be between 1 and 63 characters long, maximum of 64 characters.
Count	Enter the number of echo requests to send. The default value is 4. The value ranges from 1 to 5. The count entered is not retained across a power cycle.
Interval (in sec)	Enter the interval between ping packets in seconds. The default value is 1. The value ranges from 1 to 5. The interval entered is not retained across a power cycle.
Size (in bytes)	Enter the size of ping packet. The default value is 56. The value ranges from 8 to 5120. The size entered is not retained across a power cycle.

Item	Description
Ping Results	<p>Display the reply format of ping. PING 172.17.8.254 (172.17.8.254): 56 data bytes</p> <p>--- 172.17.8.254 ping statistics --- 4 packets transmitted, 0 packets received, 100% packet loss Or PING 172.17.8.93 (172.17.8.93): 56 data bytes 64 bytes from 172.17.8.93: icmp_seq=0 ttl=128 time=0.0 ms 64 bytes from 172.17.8.93: icmp_seq=1 ttl=128 time=0.0 ms 64 bytes from 172.17.8.93: icmp_seq=2 ttl=128 time=0.0 ms 64 bytes from 172.17.8.93: icmp_seq=3 ttl=128 time=0.0 ms</p> <p>--- 172.17.8.93 ping statistics --- 4 packets transmitted, 4 packets received, 0% packet loss round-trip min/avg/max = 0.0/0.0/0.0 ms</p>
Apply	Click Apply to display ping result for the IP address.

4.10.3 IPv6 Ping Test

The IPv6 Ping Test page allows you to configure the Ping Test for IPv6.

To access this page, click **Diagnostics > IPv6 Ping Test**.

Figure 4.133 Diagnostics > IPv6 Ping Test

The following table describes the items in the previous figure.

Item	Description
IPv6 Address	Enter the IP address or host name of the station you want the switch to ping. The initial value is blank. The IP Address or host name you enter is not retained across a power cycle. Host names are composed of series of labels concatenated with dots. Each label must be between 1 and 63 characters long, and the entire hostname has a maximum of 64 characters.
Count	Enter the number of echo requests you want to send. The default value is 4. The value ranges from 1 to 5. The count you enter is not retained across a power cycle.
Interval (in sec)	Enter the interval between ping packets in seconds. The default value is 1. The value ranges from 1 to 5. The interval you enter is not retained across a power cycle.
Size (in bytes)	Enter the size of ping packet. The default value is 56. The value ranges from 8 to 5120. The size you enter is not retained across a power cycle.
Ping Results	<p>Display the reply format of ping.</p> <pre> PING 2222::777 (2222::777): 56 data bytes --- 2222::777 ping statistics --- 4 packets transmitted, 0 packets received, 100% packet loss Or PING 2222::717 (2222::717): 56 data bytes 64 bytes from 2222::717: icmp6_seq=0 ttl=128 time=10.0 ms 64 bytes from 2222::717: icmp6_seq=1 ttl=128 time=0.0 ms 64 bytes from 2222::717: icmp6_seq=2 ttl=128 time=0.0 ms 64 bytes from 2222::717: icmp6_seq=3 ttl=128 time=0.0 ms --- 2222::717 ping statistics --- 4 packets transmitted, 4 packets received, 0% packet loss round-trip min/avg/max = 0.0/2.5/10.0 ms </pre>
Apply	Click Apply to display ping result for the IP address.

4.10.4 System Log

4.10.4.1 Logging Service

The Logging Service page allows you to setup the logging services feature for the system log.

To access this page, click **Diagnostics > System Log > Logging Service**.

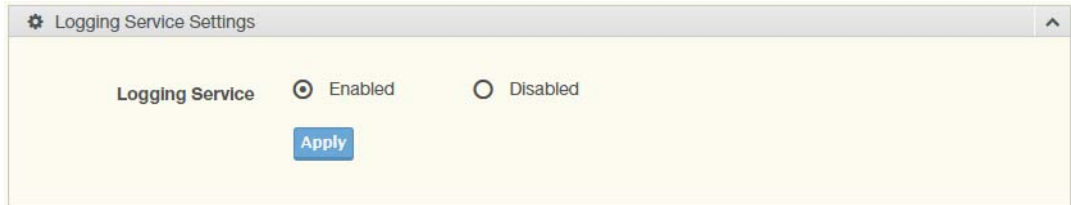

Figure 4.134 Diagnostics > System Log > Logging Service

The following table describes the items in the previous figure.

Item	Description
Logging Service	Click Enabled or Disabled to set the Logging Service status.
Apply	Click Apply to save the values and update the screen.

The ensuing table for **Logging Information** settings are informational only: Logging Service.

4.10.4.2 Local Logging

The Local Logging page allows you to designate a local target when the severity criteria is reached.

To access this page, click **Diagnostics > System Log > Local Logging**.



Figure 4.135 Diagnostics > System Log > Local Logging

The following table describes the items in the previous figure.

Item	Description
Target	Enter the local logging target.

Item	Description
Severity	Click the drop-down menu to select the severity level for local log messages. The level options are: <ul style="list-style-type: none"> ■ emerg: Indicates system is unusable. It is the highest level of severity ■ alert: Indicates action must be taken immediately ■ crit: Indicates critical conditions ■ error: Indicates error conditions ■ warning: Indicates warning conditions ■ notice: Indicates normal but significant conditions ■ info: Indicates informational messages ■ debug: Indicates debug-level messages
Apply	Click Apply to save the values and update the screen.

The ensuing table for **Local Logging Settings Status** settings are informational only: Status, Target, Severity and **Delete** (click to delete the desired target).

4.10.4.3 System Log Server

The System Log Server page allows you to configure the log server.

To access this page, click **Diagnostics > System Log > System Log Server**.

Figure 4.136 Diagnostics > System Log > System Log Server

The following table describes the items in the previous figure.

Item	Description
Server Address	Enter the IP address of the log server.
Server Port	Enter the Udp port number of the log server.
Severity	Click the drop-down menu to select the severity level for local log messages. The default is emerg. The level options are: <ul style="list-style-type: none"> ■ emerg: Indicates system is unusable. It is the highest level of severity ■ alert: Indicates action must be taken immediately ■ crit: Indicates critical conditions ■ error: Indicates error conditions ■ warning: Indicates warning conditions ■ notice: Indicates normal but significant conditions ■ info: Indicates informational messages ■ debug: Indicates debug-level messages

Item	Description
Facility	Click the drop-down menu to select facility to which the message refers.
Apply	Click Apply to save the values and update the screen.

The ensuing table for **Remote Logging Setting Status** settings are informational only: Status, Server Info, Severity, Facility and **Delete** (click to delete the desired server address).

4.10.5 LED Indication

To access this page, click **Diagnostics > LED Indication**.

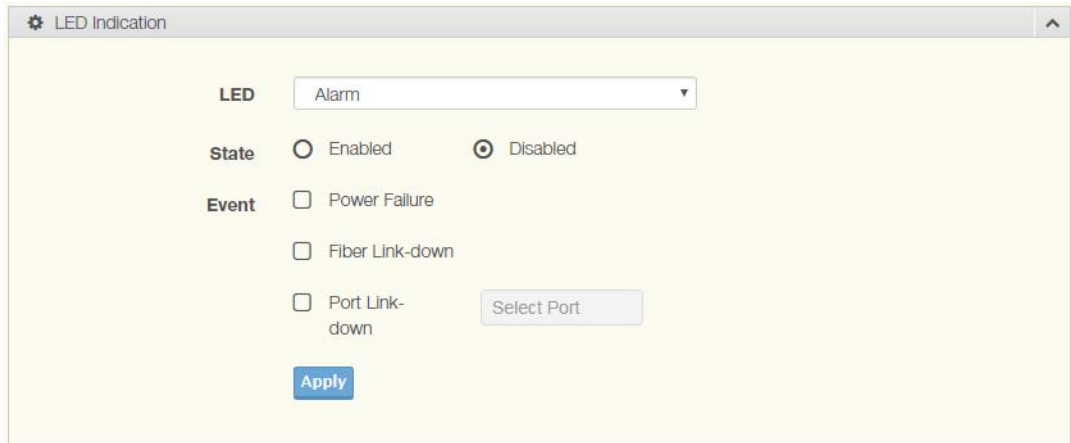

Figure 4.137 Diagnostics > LED Indication

The following table describes the items in the previous figure.

Item	Description
LED	Click the drop-down menu to select LED indicator.
State	Select Enable or Disable to enable LED alarm.
Event	Click to select the event of LED alarm.
Apply	Click Apply to save the values and update the screen.

The ensuing table for **LED Information** settings are informational only: Alarm.

The ensuing table for **Event Information** settings are informational only: LED (click the drop down menu to select LED), Event, State, and **Delete** (click to delete the desired event).

4.11 Tools

4.11.1 IXM

The IXM tool is an industrial Ethernet switch solution to help the users deploy industrial Ethernet switch hardware by allowing users with multiple, managed Ethernet switches in the field to eliminate the need to individually connect to each device to configure it.

To access this page, click **Tools > IXM**.

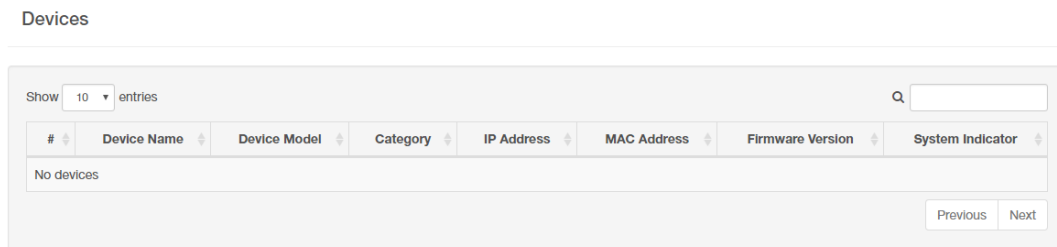

Figure 4.138 Tools > IXM

The following table describes the items in the previous figure.

Item	Description
Search Field	Enter criteria to search the IXM information.
#	Displays the reference to the device number.
Device Name	Displays the device name.
Device Model	Displays the device model type.
Category	Displays the device's category type.
IP Address	Displays the device's IP address.
MAC Address	Displays the device's IP MAC address.
Firmware Version	Displays the device's firmware version.
System Indicator	Displays the device's system indicator.
Previous	Click Previous to back to previous page.
Next	Click Next to go to next page.

4.11.2 Backup Manager

The Backup Manager page allows you to configure a remote TFTP sever or host file system in order to backup the firmware image or configuration file.

To access this page, click **Tools > Backup Manager**.

The following figures represent multiple supported devices. Some interface screens may represent specific device models.

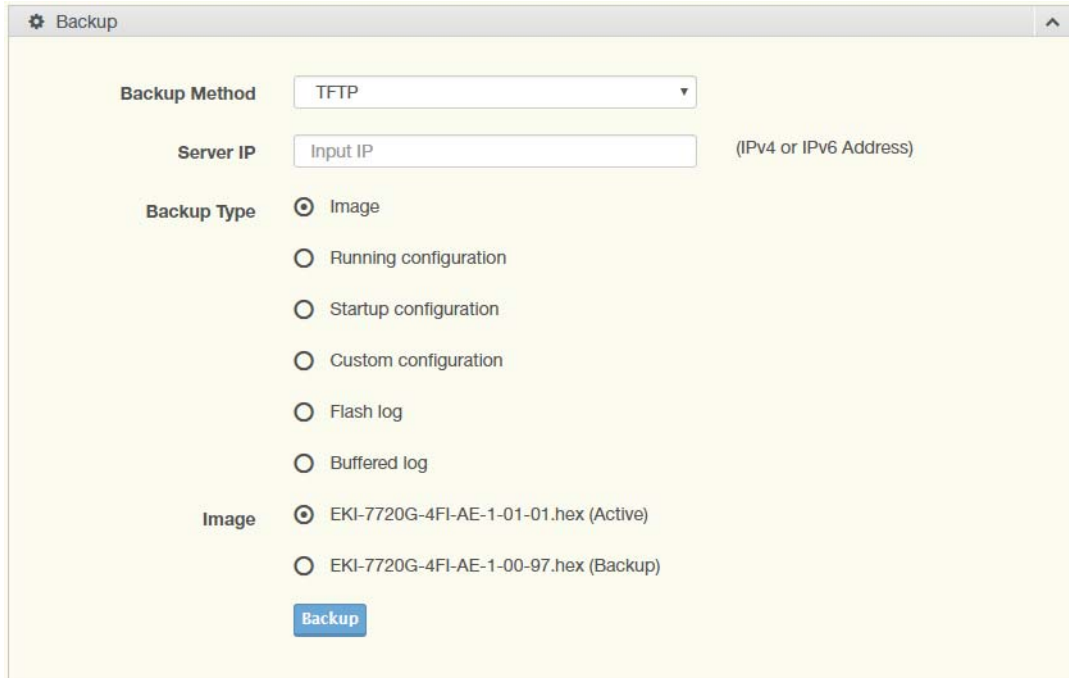

The screenshot shows a web interface for the Backup Manager. It features a title bar with a gear icon and the word 'Backup'. Below the title bar, there are several configuration sections: 'Backup Method' with a dropdown menu set to 'TFTP'; 'Server IP' with a text input field containing 'Input IP' and a note '(IPv4 or IPv6 Address)'; 'Backup Type' with a list of radio buttons: 'Image' (selected), 'Running configuration', 'Startup configuration', 'Custom configuration', 'Flash log', and 'Buffered log'; and 'Image' with two radio buttons: 'EKI-7720G-4FI-AE-1-01-01.hex (Active)' (selected) and 'EKI-7720G-4FI-AE-1-00-97.hex (Backup)'. At the bottom, there is a blue 'Backup' button.

Figure 4.139 Tools > Backup Manager

The following table describes the items in the previous figure.

Item	Description
Backup Method	Click the drop-down menu to select the backup method: TFTP or HTTP.
Server IP	Enter the IP address of the backup server.
Backup Type	Click a type to define the backup method: image: running configuration, startup configuration, custom configuration, flash log, or buffered log.
Image	Click the format for the image type: Active or Backup.
Backup	Click Backup to backup the settings.

4.11.3 Upgrade Manager

The Upgrade Manager page allows you to configure a remote TFTP sever or host file system in order to upload firmware upgrade images or configuration files.

To access this page, click **Tools > Upgrade Manager**.

The following figures represent multiple supported devices. Some interface screens may represent specific device models.

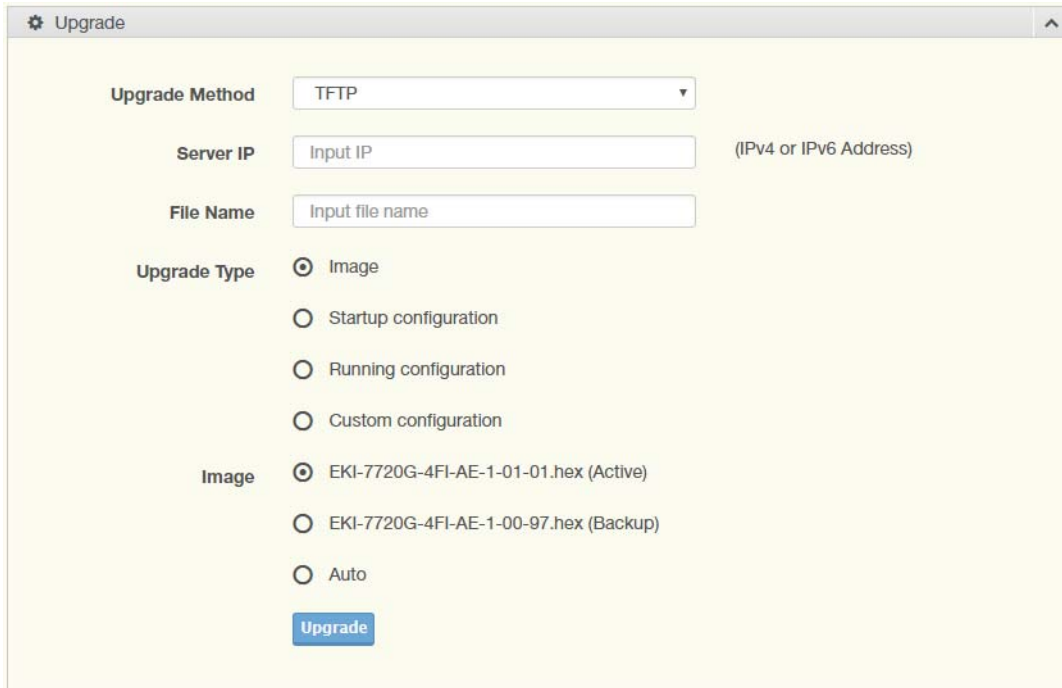

Figure 4.140 Tools > Upgrade Manager

The following table describes the items in the previous figure.

Item	Description
Upgrade Method	Click the drop-down menu to select the upgrade method: TFTP or HTTP.
Server IP	Enter the IP address of the upgrade server.
File Name	Enter the file name of the new firmware version.
Upgrade Type	Click a type to define the upgrade method: image, startup configuration, running configuration, or custom configuration.
Image	Click the format for the image type: Active, Backup, or auto.
Upgrade	Click Upgrade to upgrade to the current version.

4.11.4 Dual Image

The Dual Image page allows you to setup an active and backup partitions for firm-ware image redundancy.

To access this page, click **Tools > Dual Image**.

The following figures represent multiple supported devices. Some interface screens may represent specific device models.



Figure 4.141 Tools > Dual Image

The following table describes the items in the previous figure.

Item	Description
Active Image	Click the format for the image type: Active or Backup.
Save	Click Save to save and keep the new settings.

The ensuing table for **Image Information 0/1** settings are informational only: Flash Partition, Image Name, Image Size and Created Time.

4.11.5 Save Configuration

To access this page, click **Tools > Save Configuration**.

Click **Save Configuration to FLASH** to have configuration changes you have made to be saved across a system reboot. All changes submitted since the previous save or system reboot will be retained by the switch.

4.11.6 User Account

The User Account page allows you to setup a user and the related parameters.

To access this page, click **Tools > User Account**.

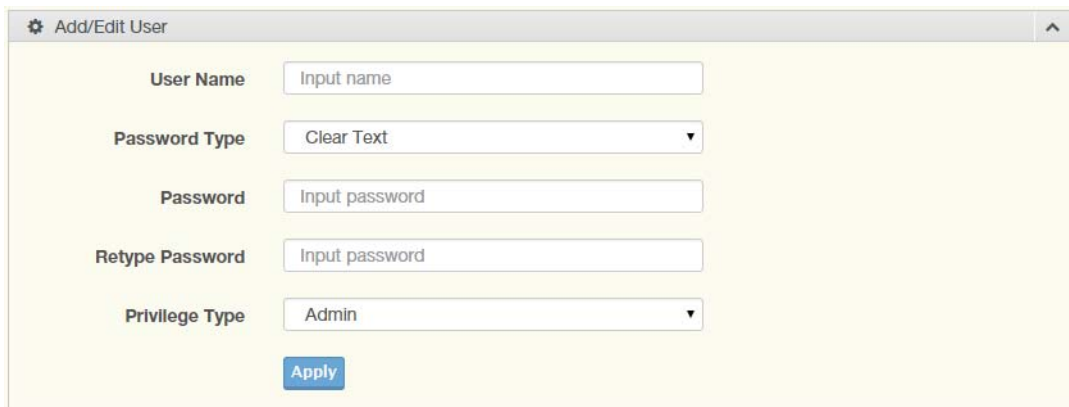

Figure 4.142 Tools > User Account

The following table describes the items in the previous figure.

Item	Description
User Name	Enter the name of the new user entry.

Item	Description
Password Type	Click the drop-down menu to define the type of password: Clear Text , Encrypted or No Password .
Password	Enter the character set for the define password type.
Retype Password	Retype the password entry to confirm the profile password.
Privilege Type	Click the drop-down menu to designate privilege authority for the user entry: Admin or User .
Apply	Click Apply to create a new user account.

The ensuing table for **Local Users** settings are informational only: User Name, Password Type, Privilege Type and **Delete** (click to delete the desired user account).

4.11.7 N-Key

To access this page, click **Tools > N-Key**.

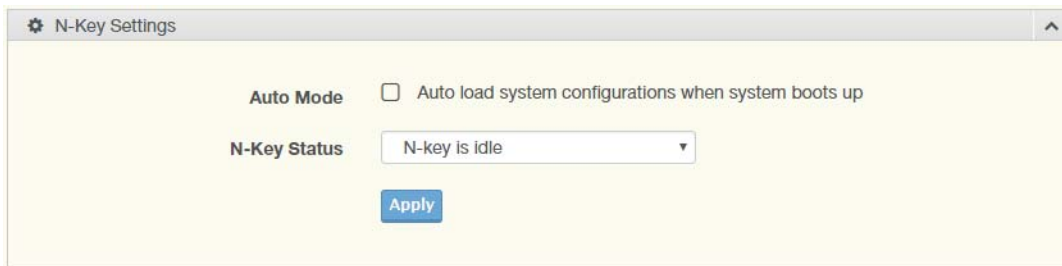

Figure 4.143 Tools > N-Key

The following table describes the items in the previous figure.

Item	Description
Auto Mode	Click the option to set the auto mode for the N-Key status.
N-Key Status	Click the drop-down menu to select N-Key status.
Apply	Click Apply to create a new user account.

The ensuing table for **N-Key Information** settings are informational only: Auto Mode and N-Key Status.

4.11.8 Reset System

To access this page, click **Tools > Reset System**.

Click **Restore** to have all configuration parameters reset to their factory default values. All changes that have been made will be lost, even if you have issued a save.

Click **Select Excepted Configuration** to keep the configuration you selected when resetting.

Reset settings take effect after a system reboot.

4.11.9 Reboot Device

To access this page, click **Tools > Reboot Device**.

Click **Reboot** to reboot the switch. Any configuration changes you have made since the last time you issued a save will be lost.

4.12 Modbus/TCP Mapping

The data map addresses of Advantech switches shown in the following table start from Modbus address 30001 for function code 4.

In the given example, the address offset 0x1000 (hex) equals Modbus address 34097, while the address offset 0x1100 (hex) equals Modbus address 34353.

The information given by the Advantech is shown in hex mode.

4.12.1 Modbus/TCP Mapping Table

Catalog	Name	Data Type	Interpretation	Address Offset (Hex)	Address 3X	Description	
System Info	Vendor ID = 0x13FE	1 word	16 bits	HEX	0x0000	30001	Vendor ID = 0x13FE
	Unit ID = 0xFF	1 word	16 bits	HEX	0x0001	30002	Unit ID = 0xFF
	Product Code	1 word	16 bits	HEX	0x0002	30003	Product Code
	Vendor Name = "Advantech"	16 words	32 chars	ASCII	0x0010	30017	Vendor Name = "Advantech" Word 0 Hi byte = 'A' Word 0 Lo byte = 'd' Word 1 Hi byte = 'v' Word 1 Lo byte = 'a' Word 2 Hi byte = 'n' Word 2 Lo byte = 't' Word 3 Hi byte = 'e' Word 3 Lo byte = 'c' Word 4 Hi byte = 'h' Word 4 Lo byte = '\0'
Product Name = "EKI-xxxx"	16 words	32 chars	ASCII	0x0020	30033	Product Name = "EKI-xxxx" Word 0 Hi byte = 'E' Word 0 Lo byte = 'K' Word 1 Hi byte = 'I' Word 1 Lo byte = '-' Word 2 Hi byte = 'x' Word 2 Lo byte = 'x' Word 3 Hi byte = 'x' Word 3 Lo byte = 'x' Word 4 Hi byte = '\0'	
Firmware Version	2 words	32 bits	HEX	0x020A	30523	Firmware Version Word 0 Hi byte = major Word 0 Lo byte = minor Word 1 Hi byte = release Word 1 Lo byte = build	

Catalog	Name	Data Type	Interpretation	Address Offset (Hex)	Address 3X	Description	
System Info	Ethernet MAC Address	3 words	48 bits	HEX	0x020E	30527	Ethernet MAC Address Ex: MAC = 00-19-CB-01-02-03 Word 0 Hi byte = 0x00 Word 0 Lo byte = 0x19 Word 1 Hi byte = 0xCB Word 1 Lo byte = 0x01 Word 2 Hi byte = 0x02 Word 2 Lo byte = 0x03
	Revision Number	16 words	32 chars	ASCII	0x0211	30530	Product Name = "YYY.xxxx" Word 0 Hi byte = 'Y' Word 0 Lo byte = 'Y' Word 1 Hi byte = 'Y' Word 1 Lo byte = '.' Word 2 Hi byte = 'x' Word 2 Lo byte = 'x' Word 3 Hi byte = 'x' Word 3 Lo byte = 'x' Word 4 Hi byte = 'x' Word 4 Lo byte = '\0'
	IP Address	2 words	32 bits	HEX	0x0400	31025	IP Address Ex: IP = 192.168.1.1 Word 0 Hi byte = 0xC0 Word 0 Lo byte = 0xA8 Word 1 Hi byte = 0x01 Word 1 Lo byte = 0x01
Port Info	Port Status	1 word	16 bits	HEX	0x1000 ~ 0x101F	34097 ~ 34128	Port Status 0x0000: Link down 0x0001: Link up 0xFFFF: No port
	Port 1 Status	1 word	16 bits	HEX	0x1000	34097	
	Port 2 Status	1 word	16 bits	HEX	0x1001	34098	
	Port 3 Status	1 word	16 bits	HEX	0x1002	34099	
	Port 4 Status	1 word	16 bits	HEX	0x1003	34100	
	Port 5 Status	1 word	16 bits	HEX	0x1004	34101	
	Port 6 Status	1 word	16 bits	HEX	0x1005	34102	
	Port 7 Status	1 word	16 bits	HEX	0x1006	34103	
	Port 8 Status	1 word	16 bits	HEX	0x1007	34104	
	Port 9 Status	1 word	16 bits	HEX	0x1008	34105	
	Port 10 Status	1 word	16 bits	HEX	0x1009	34106	
	Port 11 Status	1 word	16 bits	HEX	0x100A	34107	
	Port 12 Status	1 word	16 bits	HEX	0x100B	34108	
	Port 13 Status	1 word	16 bits	HEX	0x100C	34109	
	Port 14 Status	1 word	16 bits	HEX	0x100D	34110	

Catalog	Name	Data Type	Interpretation	Address Offset (Hex)	Address 3X	Description	
System Info	Ethernet MAC Address	3 words	48 bits	HEX	0x020E	30527	Ethernet MAC Address Ex: MAC = 00-19-CB-01-02-03 Word 0 Hi byte = 0x00 Word 0 Lo byte = 0x19 Word 1 Hi byte = 0xCB Word 1 Lo byte = 0x01 Word 2 Hi byte = 0x02 Word 2 Lo byte = 0x03
	Revision Number	16 words	32 chars	ASCII	0x0211	30530	Product Name = "YYY.xxxxx" Word 0 Hi byte = 'Y' Word 0 Lo byte = 'Y' Word 1 Hi byte = 'Y' Word 1 Lo byte = '.' Word 2 Hi byte = 'x' Word 2 Lo byte = 'x' Word 3 Hi byte = 'x' Word 3 Lo byte = 'x' Word 4 Hi byte = 'x' Word 4 Lo byte = '0'
	IP Address	2 words	32 bits	HEX	0x0400	31025	IP Address Ex: IP = 192.168.1.1 Word 0 Hi byte = 0xC0 Word 0 Lo byte = 0xA8 Word 1 Hi byte = 0x01 Word 1 Lo byte = 0x01
Port Info	Port Status	1 word	16 bits	HEX	0x1000 ~ 0x101F	34097 ~ 34128	Port Status 0x0000: Link down 0x0001: Link up 0xFFFF: No port
	Port 1 Status	1 word	16 bits	HEX	0x1000	34097	
	Port 2 Status	1 word	16 bits	HEX	0x1001	34098	
	Port 3 Status	1 word	16 bits	HEX	0x1002	34099	
	Port 4 Status	1 word	16 bits	HEX	0x1003	34100	
	Port 5 Status	1 word	16 bits	HEX	0x1004	34101	
	Port 6 Status	1 word	16 bits	HEX	0x1005	34102	
	Port 7 Status	1 word	16 bits	HEX	0x1006	34103	
	Port 8 Status	1 word	16 bits	HEX	0x1007	34104	
	Port 9 Status	1 word	16 bits	HEX	0x1008	34105	
	Port 10 Status	1 word	16 bits	HEX	0x1009	34106	
	Port 11 Status	1 word	16 bits	HEX	0x100A	34107	
	Port 12 Status	1 word	16 bits	HEX	0x100B	34108	
	Port 13 Status	1 word	16 bits	HEX	0x100C	34109	
	Port 14 Status	1 word	16 bits	HEX	0x100D	34110	

Catalog	Name	Data Type	Interpretation	Address Offset (Hex)	Address 3X	Description	
Port Info	Port 15 Status	1 word	16 bits	HEX	0x100E	34111	
	Port 16 Status	1 word	16 bits	HEX	0x100F	34112	
	Port 17 Status	1 word	16 bits	HEX	0x1010	34113	
	Port 18 Status	1 word	16 bits	HEX	0x1011	34114	
	Port 19 Status	1 word	16 bits	HEX	0x1012	34115	
	Port 20 Status	1 word	16 bits	HEX	0x1013	34116	
	Port 21 Status	1 word	16 bits	HEX	0x1014	34117	
	Port 22 Status	1 word	16 bits	HEX	0x1015	34118	
	Port 23 Status	1 word	16 bits	HEX	0x1016	34119	
	Port 24 Status	1 word	16 bits	HEX	0x1017	34120	
	Port 25 Status	1 word	16 bits	HEX	0x1018	34121	
	Port 26 Status	1 word	16 bits	HEX	0x1019	34122	
	Port 27 Status	1 word	16 bits	HEX	0x101A	34123	
	Port 28 Status	1 word	16 bits	HEX	0x101B	34124	
	Port 29 Status	1 word	16 bits	HEX	0x101C	34125	
	Port 30 Status	1 word	16 bits	HEX	0x101D	34126	
	Port 31 Status	1 word	16 bits	HEX	0x101E	34127	
	Port 32 Status	1 word	16 bits	HEX	0x101F	34128	
	Port Speed	1 word	16 bits	HEX	0x1100 ~ 0x111F	34353 ~ 34384	Port Speed 0x0000: 10M-Half 0x0001: 10M-Full 0x0002: 100M-Half 0x0003: 100M-Full 0x0004: 1000M-Half 0x0005: 1000M-Full 0xFFFF: No port
	Port 1 Speed	1 word	16 bits	HEX	0x1100	34353	
	Port 2 Speed	1 word	16 bits	HEX	0x1101	34354	
	Port 3 Speed	1 word	16 bits	HEX	0x1102	34355	
	Port 4 Speed	1 word	16 bits	HEX	0x1103	34356	
	Port 5 Speed	1 word	16 bits	HEX	0x1104	34357	
	Port 6 Speed	1 word	16 bits	HEX	0x1105	34358	
	Port 7 Speed	1 word	16 bits	HEX	0x1106	34359	
	Port 8 Speed	1 word	16 bits	HEX	0x1107	34360	
	Port 9 Speed	1 word	16 bits	HEX	0x1108	34361	
	Port 10 Speed	1 word	16 bits	HEX	0x1109	34362	
	Port 11 Speed	1 word	16 bits	HEX	0x110A	34363	
	Port 12 Speed	1 word	16 bits	HEX	0x110B	34364	
	Port 13 Speed	1 word	16 bits	HEX	0x110C	34365	
	Port 14 Speed	1 word	16 bits	HEX	0x110D	34366	
Port 15 Speed	1 word	16 bits	HEX	0x110E	34367		
Port 16 Speed	1 word	16 bits	HEX	0x110F	34368		
Port 17 Speed	1 word	16 bits	HEX	0x1110	34369		
Port 18 Speed	1 word	16 bits	HEX	0x1111	34370		
Port 19 Speed	1 word	16 bits	HEX	0x1112	34371		
Port 20 Speed	1 word	16 bits	HEX	0x1113	34372		
Port 21 Speed	1 word	16 bits	HEX	0x1114	34373		
Port 22 Speed	1 word	16 bits	HEX	0x1115	34374		
Port 23 Speed	1 word	16 bits	HEX	0x1116	34375		
Port 24 Speed	1 word	16 bits	HEX	0x1117	34376		
Port 25 Speed	1 word	16 bits	HEX	0x1118	34377		
Port 26 Speed	1 word	16 bits	HEX	0x1119	34378		
Port 27 Speed	1 word	16 bits	HEX	0x111A	34379		

Catalog	Name	Data Type	Interpretation	Address Offset (Hex)	Address 3X	Description	
Port Info	Port 28 Speed	1 word	16 bits	HEX	0x111B	34380	
	Port 29 Speed	1 word	16 bits	HEX	0x111C	34381	
	Port 30 Speed	1 word	16 bits	HEX	0x111D	34382	
	Port 31 Speed	1 word	16 bits	HEX	0x111E	34383	
	Port 32 Speed	1 word	16 bits	HEX	0x111F	34384	
	Flow Control	1 word	16 bits	HEX	0x1200 ~ 0x121F	34609 ~ 34640	Flow Control 0x0000: Off 0x0001: On 0xFFFF: No port
	Port 1 Flow Control	1 word	16 bits	HEX	0x1200	34609	
	Port 2 Flow Control	1 word	16 bits	HEX	0x1201	34610	
	Port 3 Flow Control	1 word	16 bits	HEX	0x1202	34611	
	Port 4 Flow Control	1 word	16 bits	HEX	0x1203	34612	
	Port 5 Flow Control	1 word	16 bits	HEX	0x1204	34613	
	Port 6 Flow Control	1 word	16 bits	HEX	0x1205	34614	
	Port 7 Flow Control	1 word	16 bits	HEX	0x1206	34615	
	Port 8 Flow Control	1 word	16 bits	HEX	0x1207	34616	
	Port 9 Flow Control	1 word	16 bits	HEX	0x1208	34617	
	Port 10 Flow Control	1 word	16 bits	HEX	0x1209	34618	
	Port 11 Flow Control	1 word	16 bits	HEX	0x120A	34619	
	Port 12 Flow Control	1 word	16 bits	HEX	0x120B	34620	
	Port 13 Flow Control	1 word	16 bits	HEX	0x120C	34621	
	Port 14 Flow Control	1 word	16 bits	HEX	0x120D	34622	
	Port 15 Flow Control	1 word	16 bits	HEX	0x120E	34623	
	Port 16 Flow Control	1 word	16 bits	HEX	0x120F	34624	
	Port 17 Flow Control	1 word	16 bits	HEX	0x1210	34625	
	Port 18 Flow Control	1 word	16 bits	HEX	0x1211	34626	
	Port 19 Flow Control	1 word	16 bits	HEX	0x1212	34627	
Port 20 Flow Control	1 word	16 bits	HEX	0x1213	34628		
Port 21 Flow Control	1 word	16 bits	HEX	0x1214	34629		
Port 22 Flow Control	1 word	16 bits	HEX	0x1215	34630		
Port 23 Flow Control	1 word	16 bits	HEX	0x1216	34631		
Port 24 Flow Control	1 word	16 bits	HEX	0x1217	34632		
Port 25 Flow Control	1 word	16 bits	HEX	0x1218	34633		

Catalog	Name	Data Type	Interpretation	Address Offset (Hex)	Address 3X	Description
Port Info	Port 26 Flow Control	1 word	16 bits	HEX	0x1219	34634
	Port 27 Flow Control	1 word	16 bits	HEX	0x121A	34635
	Port 28 Flow Control	1 word	16 bits	HEX	0x121B	34636
	Port 29 Flow Control	1 word	16 bits	HEX	0x121C	34637
	Port 30 Flow Control	1 word	16 bits	HEX	0x121D	34638
	Port 31 Flow Control	1 word	16 bits	HEX	0x121E	34639
	Port 32 Flow Control	1 word	16 bits	HEX	0x121F	34640
	Port Description	20 words	40 chars	ASCII	0x1400 ~ 0x166C	35121 ~ 35741
Port 1 Description	20 words	40 chars	ASCII	0x1400	35121	
Port 2 Description	20 words	40 chars	ASCII	0x1414	35141	
Port 3 Description	20 words	40 chars	ASCII	0x1428	35161	
Port 4 Description	20 words	40 chars	ASCII	0x143C	35181	
Port 5 Description	20 words	40 chars	ASCII	0x1450	35201	
Port 6 Description	20 words	40 chars	ASCII	0x1464	35221	
Port 7 Description	20 words	40 chars	ASCII	0x1478	35241	
Port 8 Description	20 words	40 chars	ASCII	0x148C	35261	
Port 9 Description	20 words	40 chars	ASCII	0x14A0	35281	
Port 10 Description	20 words	40 chars	ASCII	0x14B4	35301	
Port 11 Description	20 words	40 chars	ASCII	0x14C8	35321	
Port 12 Description	20 words	40 chars	ASCII	0x14DC	35341	
Port 13 Description	20 words	40 chars	ASCII	0x14F0	35361	
Port 14 Description	20 words	40 chars	ASCII	0x1504	35381	
Port 15 Description	20 words	40 chars	ASCII	0x1518	35401	

Catalog	Name	Data Type		Interpretation	Address Offset (Hex)	Address 3X	Description
Port Info	Port 16 Description	20 words	40 chars	ASCII	0x152C	35421	
	Port 17 Description	20 words	40 chars	ASCII	0x1540	35441	
	Port 18 Description	20 words	40 chars	ASCII	0x1554	35461	
	Port 19 Description	20 words	40 chars	ASCII	0x1568	35481	
	Port 20 Description	20 words	40 chars	ASCII	0x157C	35501	
	Port 21 Description	20 words	40 chars	ASCII	0x1590	35521	
	Port 22 Description	20 words	40 chars	ASCII	0x15A4	35541	
	Port 23 Description	20 words	40 chars	ASCII	0x15B8	35561	
	Port 24 Description	20 words	40 chars	ASCII	0x15CC	35581	
	Port 25 Description	20 words	40 chars	ASCII	0x15E0	35601	
	Port 26 Description	20 words	40 chars	ASCII	0x15F4	35621	
	Port 27 Description	20 words	40 chars	ASCII	0x1608	35641	
	Port 28 Description	20 words	40 chars	ASCII	0x161C	35661	
	Port 29 Description	20 words	40 chars	ASCII	0x1630	35681	
	Port 30 Description	20 words	40 chars	ASCII	0x1644	35701	
	Port 31 Description	20 words	40 chars	ASCII	0x1658	35721	
	Port 32 Description	20 words	40 chars	ASCII	0x166C	35741	
	Link Up Counter	1 word	16 bits	HEX	0x1700 ~ 0x171F	35889 ~ 35920	Link Up Counter Ex: port link up counter = 13 Received MODBUS response: 0x000D
	Port 1 Link Up Counter	1 word	16 bits	HEX	0x1700	35889	
	Port 2 Link Up Counter	1 word	16 bits	HEX	0x1701	35890	
	Port 3 Link Up Counter	1 word	16 bits	HEX	0x1702	35891	
	Port 4 Link Up Counter	1 word	16 bits	HEX	0x1703	35892	
	Port 5 Link Up Counter	1 word	16 bits	HEX	0x1704	35893	
	Port 6 Link Up Counter	1 word	16 bits	HEX	0x1705	35894	
	Port 7 Link Up Counter	1 word	16 bits	HEX	0x1706	35895	
	Port 8 Link Up Counter	1 word	16 bits	HEX	0x1707	35896	
	Port 9 Link Up Counter	1 word	16 bits	HEX	0x1708	35897	
	Port 10 Link Up Counter	1 word	16 bits	HEX	0x1709	35898	

Catalog	Name	Data Type	Interpretation	Address Offset (Hex)	Address 3X	Description	
Port Info	Port 11 Link Up Counter	1 word	16 bits	HEX	0x170A	35899	
	Port 12 Link Up Counter	1 word	16 bits	HEX	0x170B	35900	
	Port 13 Link Up Counter	1 word	16 bits	HEX	0x170C	35901	
	Port 14 Link Up Counter	1 word	16 bits	HEX	0x170D	35902	
	Port 15 Link Up Counter	1 word	16 bits	HEX	0x170E	35903	
	Port 16 Link Up Counter	1 word	16 bits	HEX	0x170F	35904	
	Port 17 Link Up Counter	1 word	16 bits	HEX	0x1710	35905	
	Port 18 Link Up Counter	1 word	16 bits	HEX	0x1711	35906	
	Port 19 Link Up Counter	1 word	16 bits	HEX	0x1712	35907	
	Port 20 Link Up Counter	1 word	16 bits	HEX	0x1713	35908	
	Port 21 Link Up Counter	1 word	16 bits	HEX	0x1714	35909	
	Port 22 Link Up Counter	1 word	16 bits	HEX	0x1715	35910	
	Port 23 Link Up Counter	1 word	16 bits	HEX	0x1716	35911	
	Port 24 Link Up Counter	1 word	16 bits	HEX	0x1717	35912	
	Port 25 Link Up Counter	1 word	16 bits	HEX	0x1718	35913	
	Port 26 Link Up Counter	1 word	16 bits	HEX	0x1719	35914	
	Port 27 Link Up Counter	1 word	16 bits	HEX	0x171A	35915	
	Port 28 Link Up Counter	1 word	16 bits	HEX	0x171B	35916	
	Port 29 Link Up Counter	1 word	16 bits	HEX	0x171C	35917	
	Port 30 Link Up Counter	1 word	16 bits	HEX	0x171D	35918	
	Port 31 Link Up Counter	1 word	16 bits	HEX	0x171E	35919	
	Port 32 Link Up Counter	1 word	16 bits	HEX	0x171F	35920	
	PoE Voltage	1 word	16 bits	HEX	0x1800 ~ 0x181F	36145 ~ 36176	PoE Voltage (V) Ex: poe voltage = 5 Received MODBUS response: 0x0005
	Port 1 PoE Voltage	1 word	16 bits	HEX	0x1800	36145	
	Port 2 PoE Voltage	1 word	16 bits	HEX	0x1801	36146	
	Port 3 PoE Voltage	1 word	16 bits	HEX	0x1802	36147	
	Port 4 PoE Voltage	1 word	16 bits	HEX	0x1803	36148	
	Port 5 PoE Voltage	1 word	16 bits	HEX	0x1804	36149	
	Port 6 PoE Voltage	1 word	16 bits	HEX	0x1805	36150	

Catalog	Name	Data Type	Interpretation	Address Offset (Hex)	Address 3X	Description	
Port Info	Port 7 PoE Voltage	1 word	16 bits	HEX	0x1806	36151	
	Port 8 PoE Voltage	1 word	16 bits	HEX	0x1807	36152	
	Port 9 PoE Voltage	1 word	16 bits	HEX	0x1808	36153	
	Port 10 PoE Voltage	1 word	16 bits	HEX	0x1809	36154	
	Port 11 PoE Voltage	1 word	16 bits	HEX	0x180A	36155	
	Port 12 PoE Voltage	1 word	16 bits	HEX	0x180B	36156	
	Port 13 PoE Voltage	1 word	16 bits	HEX	0x180C	36157	
	Port 14 PoE Voltage	1 word	16 bits	HEX	0x180D	36158	
	Port 15 PoE Voltage	1 word	16 bits	HEX	0x180E	36159	
	Port 16 PoE Voltage	1 word	16 bits	HEX	0x180F	36160	
	Port 17 PoE Voltage	1 word	16 bits	HEX	0x1810	36161	
	Port 18 PoE Voltage	1 word	16 bits	HEX	0x1811	36162	
	Port 19 PoE Voltage	1 word	16 bits	HEX	0x1812	36163	
	Port 20 PoE Voltage	1 word	16 bits	HEX	0x1813	36164	
	Port 21 PoE Voltage	1 word	16 bits	HEX	0x1814	36165	
	Port 22 PoE Voltage	1 word	16 bits	HEX	0x1815	36166	
	Port 23 PoE Voltage	1 word	16 bits	HEX	0x1816	36167	
	Port 24 PoE Voltage	1 word	16 bits	HEX	0x1817	36168	
	Port 25 PoE Voltage	1 word	16 bits	HEX	0x1818	36169	
	Port 26 PoE Voltage	1 word	16 bits	HEX	0x1819	36170	
	Port 27 PoE Voltage	1 word	16 bits	HEX	0x181A	36171	
	Port 28 PoE Voltage	1 word	16 bits	HEX	0x181B	36172	
	Port 29 PoE Voltage	1 word	16 bits	HEX	0x181C	36173	
	Port 30 PoE Voltage	1 word	16 bits	HEX	0x181D	36174	
	Port 31 PoE Voltage	1 word	16 bits	HEX	0x181E	36175	
	Port 32 PoE Voltage	1 word	16 bits	HEX	0x181F	36176	
	PoE Current	1 word	16 bits	HEX	0x1820 ~ 0x183F	36177 ~ 36208	PoE Current (mA) Ex: poe current = 13 Received MODBUS response: 0x000D
	Port 1 PoE Current	1 word	16 bits	HEX	0x1820	36177	
	Port 2 PoE Current	1 word	16 bits	HEX	0x1821	36178	

Catalog	Name	Data Type	Interpretation	Address Offset (Hex)	Address 3X	Description
Port Info	Port 3 PoE Current	1 word	16 bits	HEX	0x1822	36179
	Port 4 PoE Current	1 word	16 bits	HEX	0x1823	36180
	Port 5 PoE Current	1 word	16 bits	HEX	0x1824	36181
	Port 6 PoE Current	1 word	16 bits	HEX	0x1825	36182
	Port 7 PoE Current	1 word	16 bits	HEX	0x1826	36183
	Port 8 PoE Current	1 word	16 bits	HEX	0x1827	36184
	Port 9 PoE Current	1 word	16 bits	HEX	0x1828	36185
	Port 10 PoE Current	1 word	16 bits	HEX	0x1829	36186
	Port 11 PoE Current	1 word	16 bits	HEX	0x182A	36187
	Port 12 PoE Current	1 word	16 bits	HEX	0x182B	36188
	Port 13 PoE Current	1 word	16 bits	HEX	0x182C	36189
	Port 14 PoE Current	1 word	16 bits	HEX	0x182D	36190
	Port 15 PoE Current	1 word	16 bits	HEX	0x182E	36191
	Port 16 PoE Current	1 word	16 bits	HEX	0x182F	36192
	Port 17 PoE Current	1 word	16 bits	HEX	0x1830	36193
	Port 18 PoE Current	1 word	16 bits	HEX	0x1831	36194
	Port 19 PoE Current	1 word	16 bits	HEX	0x1832	36195
	Port 20 PoE Current	1 word	16 bits	HEX	0x1833	36196
	Port 21 PoE Current	1 word	16 bits	HEX	0x1834	36197
	Port 22 PoE Current	1 word	16 bits	HEX	0x1835	36198
	Port 23 PoE Current	1 word	16 bits	HEX	0x1836	36199
	Port 24 PoE Current	1 word	16 bits	HEX	0x1837	36200
	Port 25 PoE Current	1 word	16 bits	HEX	0x1838	36201
	Port 26 PoE Current	1 word	16 bits	HEX	0x1839	36202
	Port 27 PoE Current	1 word	16 bits	HEX	0x183A	36203
	Port 28 PoE Current	1 word	16 bits	HEX	0x183B	36204
	Port 29 PoE Current	1 word	16 bits	HEX	0x183C	36205
	Port 30 PoE Current	1 word	16 bits	HEX	0x183D	36206
	Port 31 PoE Current	1 word	16 bits	HEX	0x183E	36207
	Port 32 PoE Current	1 word	16 bits	HEX	0x183F	36208

Catalog	Name	Data Type	Interpretation	Address Offset (Hex)	Address 3X	Description
Port Info	PoE Power	1 word 16 bits	HEX	0x1840 ~ 0x185F	36209 ~ 36240	PoE Power (W) Ex: poe power = 10 Received MODBUS response: 0x000A
	Port 1 PoE Power	1 word 16 bits	HEX	0x1840	36209	
	Port 2 PoE Power	1 word 16 bits	HEX	0x1841	36210	
	Port 3 PoE Power	1 word 16 bits	HEX	0x1842	36211	
	Port 4 PoE Power	1 word 16 bits	HEX	0x1843	36212	
	Port 5 PoE Power	1 word 16 bits	HEX	0x1844	36213	
	Port 6 PoE Power	1 word 16 bits	HEX	0x1845	36214	
	Port 7 PoE Power	1 word 16 bits	HEX	0x1846	36215	
	Port 8 PoE Power	1 word 16 bits	HEX	0x1847	36216	
	Port 9 PoE Power	1 word 16 bits	HEX	0x1848	36217	
	Port 10 PoE Power	1 word 16 bits	HEX	0x1849	36218	
	Port 11 PoE Power	1 word 16 bits	HEX	0x184A	36219	
	Port 12 PoE Power	1 word 16 bits	HEX	0x184B	36220	
	Port 13 PoE Power	1 word 16 bits	HEX	0x184C	36221	
	Port 14 PoE Power	1 word 16 bits	HEX	0x184D	36222	
	Port 15 PoE Power	1 word 16 bits	HEX	0x184E	36223	
	Port 16 PoE Power	1 word 16 bits	HEX	0x184F	36224	
	Port 17 PoE Power	1 word 16 bits	HEX	0x1850	36225	
	Port 18 PoE Power	1 word 16 bits	HEX	0x1851	36226	
	Port 19 PoE Power	1 word 16 bits	HEX	0x1852	36227	
	Port 20 PoE Power	1 word 16 bits	HEX	0x1853	36228	
	Port 21 PoE Power	1 word 16 bits	HEX	0x1854	36229	
	Port 22 PoE Power	1 word 16 bits	HEX	0x1855	36230	
	Port 23 PoE Power	1 word 16 bits	HEX	0x1856	36231	
	Port 24 PoE Power	1 word 16 bits	HEX	0x1857	36232	
	Port 25 PoE Power	1 word 16 bits	HEX	0x1858	36233	
	Port 26 PoE Power	1 word 16 bits	HEX	0x1859	36234	
	Port 27 PoE Power	1 word 16 bits	HEX	0x185A	36235	
	Port 28 PoE Power	1 word 16 bits	HEX	0x185B	36236	

Catalog	Name	Data Type	Interpretation	Address Offset (Hex)	Address 3X	Description	
Port Info	Port 29 PoE Power	1 word	16 bits	HEX	0x185C	36237	
	Port 30 PoE Power	1 word	16 bits	HEX	0x185D	36238	
	Port 31 PoE Power	1 word	16 bits	HEX	0x185E	36239	
	Port 32 PoE Power	1 word	16 bits	HEX	0x185F	36240	
	PoE Temperature	1 word	16 bits	HEX	0x1860 ~ 0x187F	36241 ~ 36272	PoE Temperature (C) Ex: poe temperature = 32 Received MODBUS response: 0x0020
	Port 1 PoE Temperature	1 word	16 bits	HEX	0x1860	36241	
	Port 2 PoE Temperature	1 word	16 bits	HEX	0x1861	36242	
	Port 3 PoE Temperature	1 word	16 bits	HEX	0x1862	36243	
	Port 4 PoE Temperature	1 word	16 bits	HEX	0x1863	36244	
	Port 5 PoE Temperature	1 word	16 bits	HEX	0x1864	36245	
	Port 6 PoE Temperature	1 word	16 bits	HEX	0x1865	36246	
	Port 7 PoE Temperature	1 word	16 bits	HEX	0x1866	36247	
	Port 8 PoE Temperature	1 word	16 bits	HEX	0x1867	36248	
	Port 9 PoE Temperature	1 word	16 bits	HEX	0x1868	36249	
	Port 10 PoE Temperature	1 word	16 bits	HEX	0x1869	36250	
	Port 11 PoE Temperature	1 word	16 bits	HEX	0x186A	36251	
	Port 12 PoE Temperature	1 word	16 bits	HEX	0x186B	36252	
	Port 13 PoE Temperature	1 word	16 bits	HEX	0x186C	36253	
	Port 14 PoE Temperature	1 word	16 bits	HEX	0x186D	36254	
	Port 15 PoE Temperature	1 word	16 bits	HEX	0x186E	36255	
	Port 16 PoE Temperature	1 word	16 bits	HEX	0x186F	36256	
	Port 17 PoE Temperature	1 word	16 bits	HEX	0x1870	36257	
	Port 18 PoE Temperature	1 word	16 bits	HEX	0x1871	36258	
Port 19 PoE Temperature	1 word	16 bits	HEX	0x1872	36259		
Port 20 PoE Temperature	1 word	16 bits	HEX	0x1873	36260		
Port 21 PoE Temperature	1 word	16 bits	HEX	0x1874	36261		
Port 22 PoE Temperature	1 word	16 bits	HEX	0x1875	36262		
Port 23 PoE Temperature	1 word	16 bits	HEX	0x1876	36263		

Catalog	Name	Data Type	Interpretation	Address Offset (Hex)	Address 3X	Description	
Port Info	Port 24 PoE Temperature	1 word	16 bits	HEX	0x1877	36264	
	Port 25 PoE Temperature	1 word	16 bits	HEX	0x1878	36265	
	Port 26 PoE Temperature	1 word	16 bits	HEX	0x1879	36266	
	Port 27 PoE Temperature	1 word	16 bits	HEX	0x187A	36267	
	Port 28 PoE Temperature	1 word	16 bits	HEX	0x187B	36268	
	Port 29 PoE Temperature	1 word	16 bits	HEX	0x187C	36269	
	Port 30 PoE Temperature	1 word	16 bits	HEX	0x187D	36270	
	Port 31 PoE Temperature	1 word	16 bits	HEX	0x187E	36271	
	Port 32 PoE Temperature	1 word	16 bits	HEX	0x187F	36272	
	Packet Info	Tx Packets Counter	4 words	64 bits	HEX	0x2000 ~ 0x207C	38193 ~ 38317
Port 1 Tx Packets		4 words	64 bits	HEX	0x2000	38193	
Port 2 Tx Packets		4 words	64 bits	HEX	0x2004	38197	
Port 3 Tx Packets		4 words	64 bits	HEX	0x2008	38201	
Port 4 Tx Packets		4 words	64 bits	HEX	0x200C	38205	
Port 5 Tx Packets		4 words	64 bits	HEX	0x2010	38209	
Port 6 Tx Packets		4 words	64 bits	HEX	0x2014	38213	
Port 7 Tx Packets		4 words	64 bits	HEX	0x2018	38217	
Port 8 Tx Packets		4 words	64 bits	HEX	0x201C	38221	
Port 9 Tx Packets		4 words	64 bits	HEX	0x2020	38225	
Port 10 Tx Packets		4 words	64 bits	HEX	0x2024	38229	
Port 11 Tx Packets		4 words	64 bits	HEX	0x2028	38233	
Port 12 Tx Packets		4 words	64 bits	HEX	0x202C	38237	
Port 13 Tx Packets		4 words	64 bits	HEX	0x2030	38241	
Port 14 Tx Packets		4 words	64 bits	HEX	0x2034	38245	
Port 15 Tx Packets		4 words	64 bits	HEX	0x2038	38249	
Port 16 Tx Packets		4 words	64 bits	HEX	0x203C	38253	

Catalog	Name	Data Type		Interpretation	Address Offset (Hex)	Address 3X	Description
Packet Info	Port 17 Tx Packets	4 words	64 bits	HEX	0x2040	38257	
	Port 18 Tx Packets	4 words	64 bits	HEX	0x2044	38261	
	Port 19 Tx Packets	4 words	64 bits	HEX	0x2048	38265	
	Port 20 Tx Packets	4 words	64 bits	HEX	0x204C	38269	
	Port 21 Tx Packets	4 words	64 bits	HEX	0x2050	38273	
	Port 22 Tx Packets	4 words	64 bits	HEX	0x2054	38277	
	Port 23 Tx Packets	4 words	64 bits	HEX	0x2058	38281	
	Port 24 Tx Packets	4 words	64 bits	HEX	0x205C	38285	
	Port 25 Tx Packets	4 words	64 bits	HEX	0x2060	38289	
	Port 26 Tx Packets	4 words	64 bits	HEX	0x2064	38293	
	Port 27 Tx Packets	4 words	64 bits	HEX	0x2068	38297	
	Port 28 Tx Packets	4 words	64 bits	HEX	0x206C	38301	
	Port 29 Tx Packets	4 words	64 bits	HEX	0x2070	38305	
	Port 30 Tx Packets	4 words	64 bits	HEX	0x2074	38309	
	Port 31 Tx Packets	4 words	64 bits	HEX	0x2078	38313	
	Port 32 Tx Packets	4 words	64 bits	HEX	0x207C	38317	
	Rx Packets Counter	4 words	64 bits	HEX	0x2100 ~0x217C	38449 ~ 38573	Rx Packets Ex: port 1 Rx Packet Amount = 11223344 Received MODBUS response: 0xAB4130 Word 0 = 0x0000 Word 1 = 0x0000 Word 2 = 0x00AB Word 3 = 0x4130
	Port 1 Rx Packets	4 words	64 bits	HEX	0x2100	38449	
	Port 2 Rx Packets	4 words	64 bits	HEX	0x2104	38453	
	Port 3 Rx Packets	4 words	64 bits	HEX	0x2108	38457	
	Port 4 Rx Packets	4 words	64 bits	HEX	0x210C	38461	
	Port 5 Rx Packets	4 words	64 bits	HEX	0x2110	38465	
	Port 6 Rx Packets	4 words	64 bits	HEX	0x2114	38469	
	Port 7 Rx Packets	4 words	64 bits	HEX	0x2118	38473	
	Port 8 Rx Packets	4 words	64 bits	HEX	0x211C	38477	
	Port 9 Rx Packets	4 words	64 bits	HEX	0x2120	38481	

Catalog	Name	Data Type	Interpretation	Address Offset (Hex)	Address 3X	Description	
Packet Info	Port 10 Rx Packets	4 words	64 bits	HEX	0x2124	38485	
	Port 11 Rx Packets	4 words	64 bits	HEX	0x2128	38489	
	Port 12 Rx Packets	4 words	64 bits	HEX	0x212C	38493	
	Port 13 Rx Packets	4 words	64 bits	HEX	0x2130	38497	
	Port 14 Rx Packets	4 words	64 bits	HEX	0x2134	38501	
	Port 15 Rx Packets	4 words	64 bits	HEX	0x2138	38505	
	Port 16 Rx Packets	4 words	64 bits	HEX	0x213C	38509	
	Port 17 Rx Packets	4 words	64 bits	HEX	0x2140	38513	
	Port 18 Rx Packets	4 words	64 bits	HEX	0x2144	38517	
	Port 19 Rx Packets	4 words	64 bits	HEX	0x2148	38521	
	Port 20 Rx Packets	4 words	64 bits	HEX	0x214C	38525	
	Port 21 Rx Packets	4 words	64 bits	HEX	0x2150	38529	
	Port 22 Rx Packets	4 words	64 bits	HEX	0x2154	38533	
	Port 23 Rx Packets	4 words	64 bits	HEX	0x2158	38537	
	Port 24 Rx Packets	4 words	64 bits	HEX	0x215C	38541	
	Port 25 Rx Packets	4 words	64 bits	HEX	0x2160	38545	
	Port 26 Rx Packets	4 words	64 bits	HEX	0x2164	38549	
	Port 27 Rx Packets	4 words	64 bits	HEX	0x2168	38553	
	Port 28 Rx Packets	4 words	64 bits	HEX	0x216C	38557	
	Port 29 Rx Packets	4 words	64 bits	HEX	0x2170	38561	
	Port 30 Rx Packets	4 words	64 bits	HEX	0x2174	38565	
	Port 31 Rx Packets	4 words	64 bits	HEX	0x2178	38569	
	Port 32 Rx Packets	4 words	64 bits	HEX	0x217C	38573	
	Tx Error Packets Counter	2 words	32 bits	HEX	0x2200 ~ 0x223E	38705 ~ 38767	Tx Error Packets Ex: port 1 Tx Packet Amount = 11223344 Received MODBUS response: 0xAB4130 Word 0 = 0x00AB Word 1 = 0x4130
	Port 1 Tx Error Packets	2 words	32 bits	HEX	0x2200	38705	
	Port 2 Tx Error Packets	2 words	32 bits	HEX	0x2202	38707	
	Port 3 Tx Error Packets	2 words	32 bits	HEX	0x2204	38709	

Catalog	Name	Data Type	Interpretation	Address Offset (Hex)	Address 3X	Description
Packet Info	Port 4 Tx Error Packets	2 words	32 bits	HEX	0x2206	38711
	Port 5 Tx Error Packets	2 words	32 bits	HEX	0x2208	38713
	Port 6 Tx Error Packets	2 words	32 bits	HEX	0x220A	38715
	Port 7 Tx Error Packets	2 words	32 bits	HEX	0x220C	38717
	Port 8 Tx Error Packets	2 words	32 bits	HEX	0x220E	38719
	Port 9 Tx Error Packets	2 words	32 bits	HEX	0x2210	38721
	Port 10 Tx Error Packets	2 words	32 bits	HEX	0x2212	38723
	Port 11 Tx Error Packets	2 words	32 bits	HEX	0x2214	38725
	Port 12 Tx Error Packets	2 words	32 bits	HEX	0x2216	38727
	Port 13 Tx Error Packets	2 words	32 bits	HEX	0x2218	38729
	Port 14 Tx Error Packets	2 words	32 bits	HEX	0x221A	38731
	Port 15 Tx Error Packets	2 words	32 bits	HEX	0x221C	38733
	Port 16 Tx Error Packets	2 words	32 bits	HEX	0x221E	38735
	Port 17 Tx Error Packets	2 words	32 bits	HEX	0x2220	38737
	Port 18 Tx Error Packets	2 words	32 bits	HEX	0x2222	38739
	Port 19 Tx Error Packets	2 words	32 bits	HEX	0x2224	38741
	Port 20 Tx Error Packets	2 words	32 bits	HEX	0x2226	38743
	Port 21 Tx Error Packets	2 words	32 bits	HEX	0x2228	38745
	Port 22 Tx Error Packets	2 words	32 bits	HEX	0x222A	38747
	Port 23 Tx Error Packets	2 words	32 bits	HEX	0x222C	38749
	Port 24 Tx Error Packets	2 words	32 bits	HEX	0x222E	38751
	Port 25 Tx Error Packets	2 words	32 bits	HEX	0x2230	38753
	Port 26 Tx Error Packets	2 words	32 bits	HEX	0x2232	38755
	Port 27 Tx Error Packets	2 words	32 bits	HEX	0x2234	38757
	Port 28 Tx Error Packets	2 words	32 bits	HEX	0x2236	38759
	Port 29 Tx Error Packets	2 words	32 bits	HEX	0x2238	38761
	Port 30 Tx Error Packets	2 words	32 bits	HEX	0x223A	38763
	Port 31 Tx Error Packets	2 words	32 bits	HEX	0x223C	38765
	Port 32 Tx Error Packets	2 words	32 bits	HEX	0x223E	38767

Catalog	Name	Data Type	Interpretation	Address Offset (Hex)	Address 3X	Description	
Packet Info	Rx Error Packets Counter	2 words	32 bits	HEX	0x2300 ~ 0x233E	38961 ~ 39023	Rx Error Packets Ex: port 1 Rx Packet Amount = 11223344 Received MODBUS response: 0xAB4130 Word 0 = 0x00AB Word 1 = 0x4130
	Port 1 Rx Error Packets	2 words	32 bits	HEX	0x2300	38961	
	Port 2 Rx Error Packets	2 words	32 bits	HEX	0x2302	38963	
	Port 3 Rx Error Packets	2 words	32 bits	HEX	0x2304	38965	
	Port 4 Rx Error Packets	2 words	32 bits	HEX	0x2306	38967	
	Port 5 Rx Error Packets	2 words	32 bits	HEX	0x2308	38969	
	Port 6 Rx Error Packets	2 words	32 bits	HEX	0x230A	38971	
	Port 7 Rx Error Packets	2 words	32 bits	HEX	0x230C	38973	
	Port 8 Rx Error Packets	2 words	32 bits	HEX	0x230E	38975	
	Port 9 Rx Error Packets	2 words	32 bits	HEX	0x2310	38977	
	Port 10 Rx Error Packets	2 words	32 bits	HEX	0x2312	38979	
	Port 11 Rx Error Packets	2 words	32 bits	HEX	0x2314	38981	
	Port 12 Rx Error Packets	2 words	32 bits	HEX	0x2316	38983	
	Port 13 Rx Error Packets	2 words	32 bits	HEX	0x2318	38985	
	Port 14 Rx Error Packets	2 words	32 bits	HEX	0x231A	38987	
	Port 15 Rx Error Packets	2 words	32 bits	HEX	0x231C	38989	
	Port 16 Rx Error Packets	2 words	32 bits	HEX	0x231E	38991	
	Port 17 Rx Error Packets	2 words	32 bits	HEX	0x2320	38993	
	Port 18 Rx Error Packets	2 words	32 bits	HEX	0x2322	38995	
	Port 19 Rx Error Packets	2 words	32 bits	HEX	0x2324	38997	
	Port 20 Rx Error Packets	2 words	32 bits	HEX	0x2326	38999	
	Port 21 Rx Error Packets	2 words	32 bits	HEX	0x2328	39001	
	Port 22 Rx Error Packets	2 words	32 bits	HEX	0x232A	39003	
	Port 23 Rx Error Packets	2 words	32 bits	HEX	0x232C	39005	
	Port 24 Rx Error Packets	2 words	32 bits	HEX	0x232E	39007	
	Port 25 Rx Error Packets	2 words	32 bits	HEX	0x2330	39009	
	Port 26 Rx Error Packets	2 words	32 bits	HEX	0x2332	39011	

Catalog	Name	Data Type	Interpretation	Address Offset (Hex)	Address 3X	Description
Packet Info	Port 27 Rx Error Packets	2 words	32 bits	HEX	0x2334	39013
	Port 28 Rx Error Packets	2 words	32 bits	HEX	0x2336	39015
	Port 29 Rx Error Packets	2 words	32 bits	HEX	0x2338	39017
	Port 30 Rx Error Packets	2 words	32 bits	HEX	0x233A	39019
	Port 31 Rx Error Packets	2 words	32 bits	HEX	0x233C	39021
	Port 32 Rx Error Packets	2 words	32 bits	HEX	0x233E	39023

ADVANTECH

Enabling an Intelligent Planet

www.advantech.com

Please verify specifications before quoting. This guide is intended for reference purposes only.

All product specifications are subject to change without notice.

No part of this publication may be reproduced in any form or by any means, electronic, photocopying, recording or otherwise, without prior written permission of the publisher.

All brand and product names are trademarks or registered trademarks of their respective companies.

© Advantech Co., Ltd. 2019