



Perle IDS-108FPP (XT)

Unmanaged 10/100 PoE/PoE+
Ethernet Switches with Fiber Ports



Installation Guide

P/N 5500341-10 (Rev I)

Overview

This document contains instructions necessary for the installation and operation of the Perle IDS-108FPP unmanaged Ethernet switch. This Ethernet switch is a 8-port RJ-45 switch with PoE/PoE+ capabilities on ports one through four. The PoE/PoE+ Ethernet ports function as (PSE) Power Sourcing Equipment and can each independently power a PD (Powered Device) using standard UTP cables that carry Ethernet data. Powered Devices must comply with the IEEE 802.3af or the 802at-2009 standard for PoE or PoE+ devices. The IDS-108FPP is available in various copper and fiber configurations (see table below). The fiber ports can be either single mode (SM) or multimode (MM) depending on the model selected and can operate over different wavelengths and distances. Visit the Perle website for the most up to date installation guides, models and specifications.

<http://www.perle.com/>

Model	Port 1-4	Port 5 - 8	Port 9 and 10
IDS-108FPP	TP (RJ-45) PoE/PoE+	TP (RJ-45)	empty
IDS-108FPP-xxxxxxx	TP (RJ-45) PoE/PoE+	TP (RJ-45)	1 or 2 fiber ports (SC or ST)
IDS-108FPP-XT (Industrial Temperature Model)	TP (RJ-45) PoE/ PoE+	TP (RJ-45)	empty
IDS-108FPP-xxxxxxx-XT (Industrial Temperature Model)	TP (RJ-45) PoE/PoE+	TP (RJ-45)	1 or 2 fiber ports (SC or ST)

Note: xxxxxxxx(XT) indicates models numbers for this product line.

TP = twisted pair

XT = Industrial Temperature models

Features

- 8 port 10/100Base-TX (RJ-45), with 1 or 2 fiber ports (SC/ST), multi/single mode
- 4 PoE/PoE+ PSE capable ports, fully compliant to IEEE 802.3af/at
- Redundant DC power inputs 18-57 VDC
- Rugged, high strength IP30 aluminum case
- Industrial temperature models
- Din-rail or wall/panel mounting

Note – In this guide the various models will be referred to as the IDS-108FPP

Getting to know your IDS-108FPP Switch

Package Contents:

- IDS-108FPP
- DIN-rail mounting clip (pre-installed on the unit)
- This guide

Note – optional panel/wall mounting kits may be ordered for the IDS-108FPP switch

Front View of IDS-108FPP (8 port RJ-45)

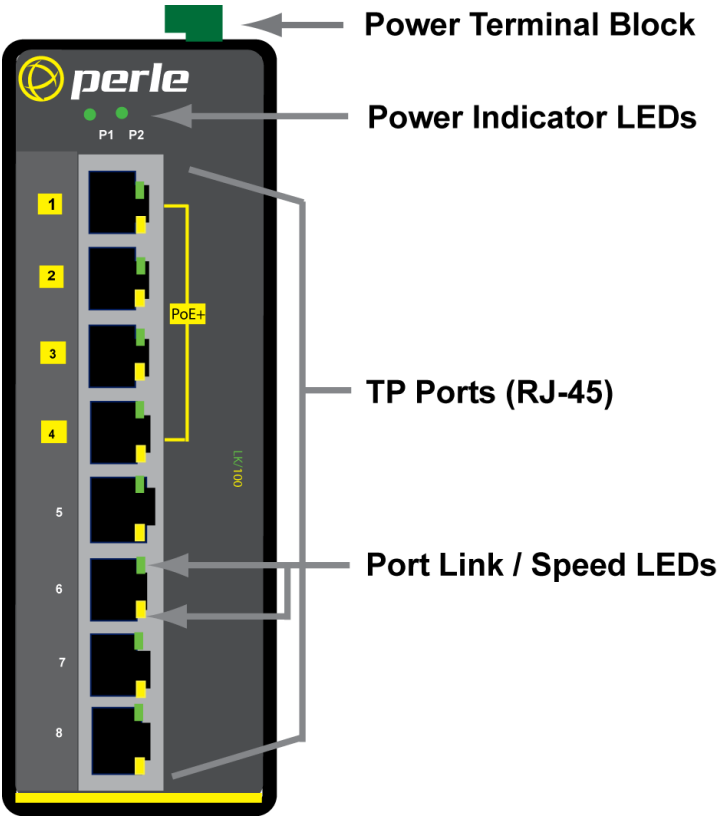

Front View of IDS-108FPP (with one or two fiber ports)

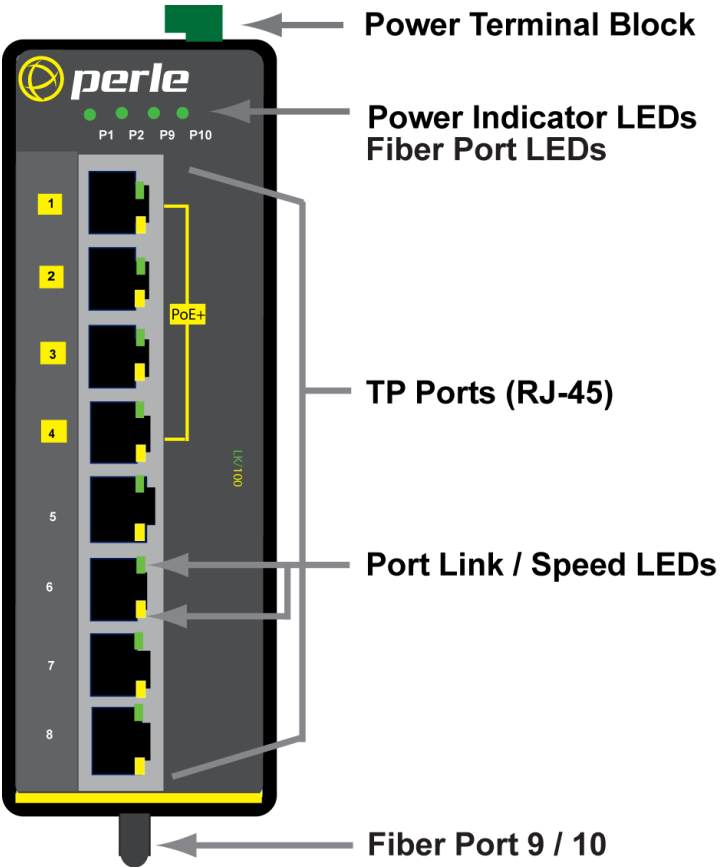

Bottom view of the IDS-108FPP (with two ST fiber ports installed)

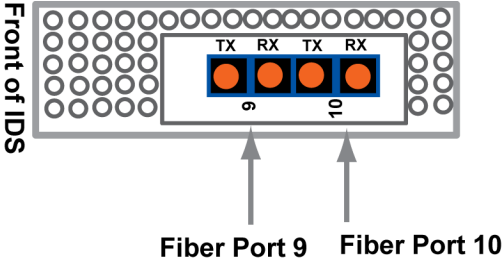

Top view of the IDS-108FPP

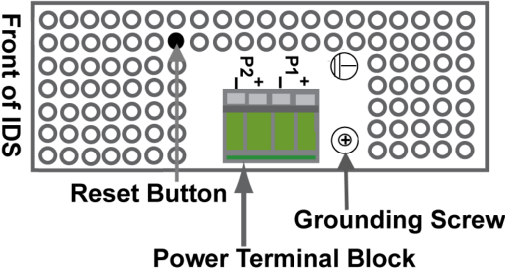

The IDS-108FPP switch has two power inputs that can be connected simultaneously. If one power source fails, the other source acts as a backup, and automatically powers the switch.

Status LED (with two fiber ports)

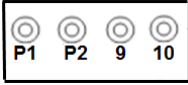

P1 / P2– Power (Green LED)

- **On:** Power present
- **Off:** No Power present

9 / 10 (Port 9 / 10 – Fiber) (Green LED)

- **On:** Link up
- **Flashing:** Link up and Ethernet activity detected
- **Off:** Link down

Ethernet Port Status



Port Link / Speed (Green and Yellow LEDs)

Port Link (Green LED)

- **On:** Link up
- **Flashing:** Link up and Ethernet activity detected

Port Speed (Yellow LED)

- **On:** communicating at 100 Mbps
- **Off:** communicating at 10 Mbps

Views for the IDS-108FPP

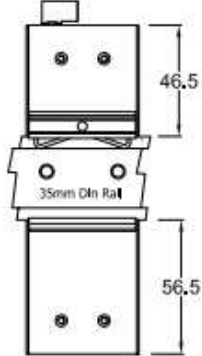
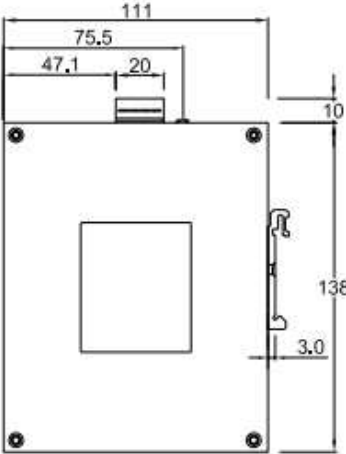
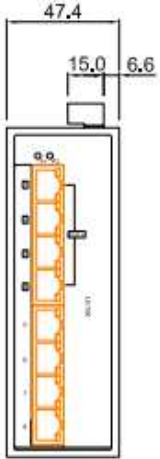
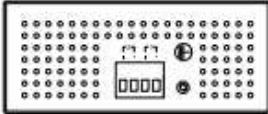

RJ45 Models

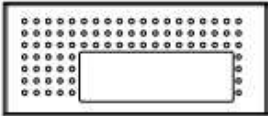

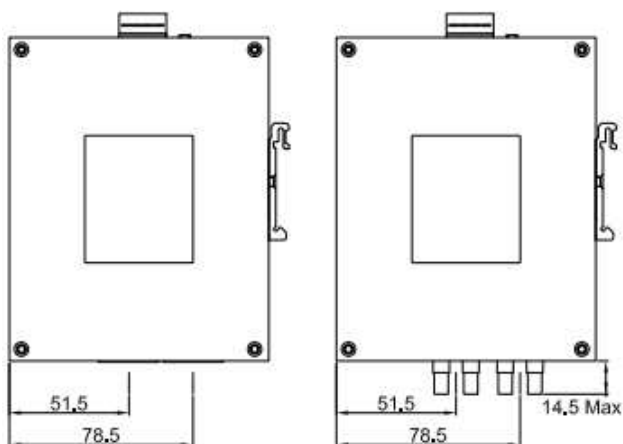

SC Models

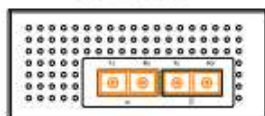

ST Models

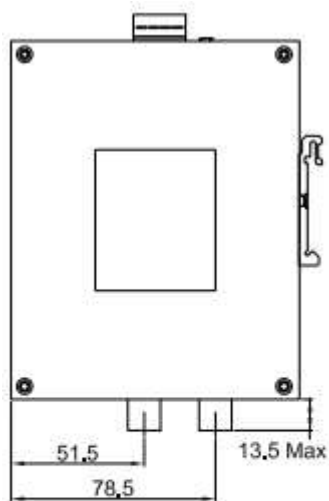
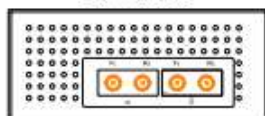

Simplex (Single Strand)

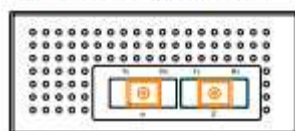

Mounting the IDS-108FPP on a DIN-rail

1. The DIN-rail clip will be fixed to the back panel of the IDS-108FPP switch when you receive the product.
2. Position the IDS-108FPP such that the top of the DIN rail fits into the slot on the top of the DIN-rail clip, just below the DIN-rail hook and behind the spring.
3. While pushing down on the unit to compress the spring, rotate the bottom of the IDS-108FPP toward the rail. This will snap the bottom of the rail into the bottom of the clip. See diagram below.

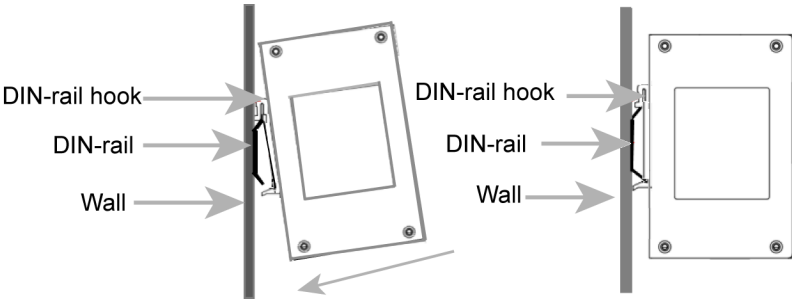

Note: To remove the IDS-108FPP from the DIN-rail, push down slightly on the IDS-108FPP unit while pulling the bottom out.

Wall Mounting the IDS-108FPP

1. Remove the DIN-rail clip from the rear panel on the IDS-108FPP.
2. Attach the wall mount plates to the IDS-108FPP as shown below using the screws provided in the kit.

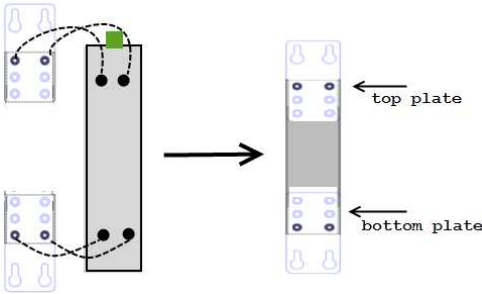

3. Use the wall mount plates as a guide to mark the spots where the screws will be.
4. Drive the screws into the wall leaving about 2 mm of the screw protruding from the wall to allow room for sliding the wall mount panel between the wall and the screws.
5. Fix the screws to the wall and then insert the four screw heads through the large parts of the keyhole shaped screw openings.
6. Pull the IDS down to lock the IDS-108FPP to the wall mount.
7. Tighten the four screws securely to the wall.

Note: For the best results use screws that have the following attributes:

Head diameter .5 - .6 mm

Shaft diameter 3 - 3.5 mm

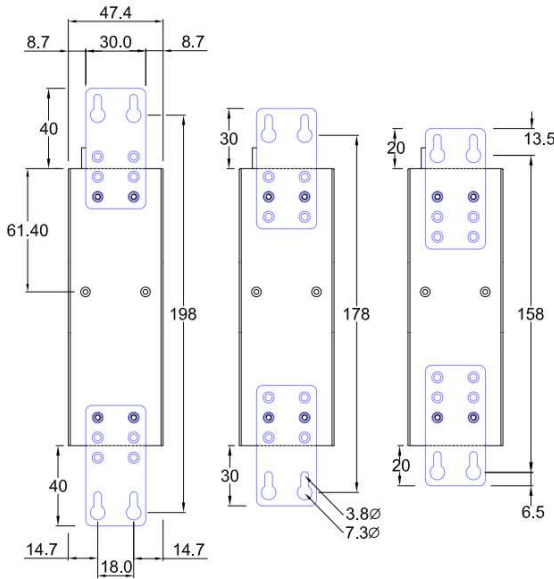

Note: the dimensions are in mm

Wiring up the IDS-108FPP



Power sources must be off prior to beginning the power connection steps.



Ensure that the voltage and current ratings of the intended power source are appropriate for the IDS-108FPP as indicated on the product label.



Ensure that the installation and electrical wiring of the equipment is performed by trained and qualified personnel and that the installation complies with all local and national electrical codes



This unit should be installed in a restricted access location where access can only be gained by service personnel or users who have been instructed about the reasons for the restrictions applied to the location and about any precautions that shall be taken; and access is through the use of a tool or lock and key, or other means of security, and is controlled by the authority responsible for the location.

Hazardous Location Warnings

(safe conditions for use:)



This equipment shall be installed in an enclosure that provides a degree of protection not less than IP54 in accordance with EN 60079-15 and accessible only by the use of a tool.



The equipment shall only be used in an area of not more than pollution degree 2, as defined in IEC 60664-1.



These devices are open-type devices that are to be installed in an enclosure with tool removable cover or door, suitable for the environment.



This equipment is suitable for use in Class I, Division 2, Groups A,B,C,D or only non hazardous locations only.



WARNING –EXPLOSION HAZARD – Do not disconnect equipment unless power has been removed or the area is known to be non-hazardous



WARNING EXPLOSION HAZARD – Substitution of any components on this switch may impair suitability for Class I, Division 2.



Transient protection shall be provided that is set at a level not exceeding 140% of the peak rated voltage value at the supply terminals to the equipment.

Connecting the IDS-108FPP to ground

If your installation requires additional grounding, follow this procedure.

Grounding the chassis requires the following items:

- One grounding lug (not provided)
 - One 12AWG wire (not provided)
1. Follow the grounding lug manufacturer's instructions for attaching the ground wire to the grounding lug.
 2. Attach the grounding lug to the chassis and secure with the grounding screw provided.

Connecting Power to the IDS-108FPP

1. Conductors suitable for use in an ambient temperature of 95°C must be used for the Power Supply Terminal.
2. Ensure the power source is off prior to connection.
3. Strip both (12AWG) wires 5mm (3/16th inch).
4. Loosen the terminal block screws and connect the positive wire (+) into the + terminal and the negative (-) wire into the - terminal.
5. Tighten terminal screws (0.51Nm torque).
6. Ensure the wires are securely fastened.
7. Re-insert the Terminal block connector if removed.
8. Turn on power source.
9. Check that the P1 LED is On.
10. If desired connect P2 (power source 2, beginning again at Step 1).
11. One individual conductor for each clamping point.

Connecting PoE/PoE+ devices

- Supports IEEE 802.3af (Type 1) and IEEE 802at-2009 (Type 2) standards.
- For PoE devices up to 15.4 Watts per port.
- For PoE+ devices up to 30 Watts per port.

Connect the copper cables from each TP port (RJ-45) on the IDS-108FPP switch to compliant Powered Devices (PDs).

See below for RJ-45 pinouts on ports 1 through 4.

RJ-45	PoE+ Option
	Alternative B
1	
2	
3	
4	Positive
5	Positive
6	
7	Negative
8	Negative

Ethernet Copper Cabling Requirements

- Category 5 UTP or STP, 5e cables
- 24-22 AWG
- Straight through or Ethernet crossover cable

Connect the copper cables from each TP port (RJ-45) on the IDS-108FPP switch to Ethernet-enabled devices.

See below for 8 pin RJ-45 pinouts.

MDI Port Pinouts

Pin	Signal
1	Tx+
2	Tx-
3	Rx+
6	Rx-

MDI-X Port Pinouts

Pin	Signal
1	Rx+
2	Rx-
3	Tx+
6	Tx-

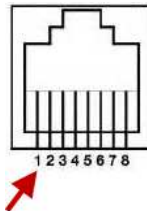

Remaining pins not used

Fiber Port Cabling Requirements

Duplex SC or ST connector

- Multimode 50/125 or 62.5/125 micron fiber cable
- Single mode 9/125 micron fiber cable

Simplex (BIDI, single strand) SC connector

- Multimode 50/125 or 62.5/125 micron fiber cable
- Single mode 9/125 micron fiber cable

Connect the fiber cable to Port 9 and Port 10 (if installed) on the IDS and the other cable end to a fiber compliant device. If you are making your own fiber cables, remember that the RX on one side needs to go to TX on the other side and vice versa. See diagram below.

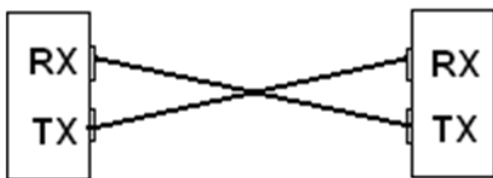

Switch Properties

- IEEE 802.3 for 10Base-T
- IEEE 802.3u for 100Base-TX and 100Base-FX
- IEEE 802.3x for Flow Control
- IEEE 802.3af Power Over Ethernet
- IEEE 802.3at Power Over Ethernet

Technical Specifications

Connection	
Dual input terminal block power	Power Input/Consumption 18-57 VDC 7.9A max
Maximum Current Consumption @24VDC	3.2 Amps (4 x PoE) 5.9 Amps (4 x PoE+)
Maximum Power Consumption@24VDC	77 Watts (4 X 15.4 Watts PoE) 143 Watts (4 X 30 Watts PoE+)
Reverse Polarity Protection	Yes
Interface	
RJ-45	8 shielded RJ-45 ports for 10/100Base-TX up to 100 meters (328ft) 4 of these ports are PoE/PoE+ PSE capable Auto-negotiation speed F/H duplex mode and auto MDI/MDI-X connection
Fiber Ports	One or two fixed fiber ports (ST/SC). See fiber specifications.
PoE/PoE+ ports	Up to 30 Watts per port (@switch) RJ-45 driving up to four class 4 (IEEE 802.3at type 2) PDs, Alternative-B (ALT-B), MDI-X pinouts, Power over-Pins 4,5 Positive and 7,8 Negative.
LED indicators	P1 /P2– power 1 / power 2 Ports 1-8 G/Y – Link/Activity/Speed Port 9/10 –port status (Fiber models only)
Environmental	
Operating Temperature	
Commercial Models (IDS-108FPP-xxxxxxx)	0°C to 60°C (32°F to 140°F)
Industrial Models (IDS-108FPP-xxxxxxx-XT)	-40°C to 75°C (-40°F to 167°F)
Storage Temperature	
Commercial Models (IDS-108FPP-xxxxxxx)	-25°C to 70°C (-13°F to 158°F)
Industrial Models (IDS-108FPP-xxxxxxx-XT)	-40°C C to 85°C (-40°F to 185°F)
Operating Humidity	5% to 90% non-condensing
Storage Humidity	5% to 95% non-condensing
Operating Altitude	Up to 3,048 m (10,000 ft)

Regulatory Approvals	
Safety	cUL 60950-1, EN 60950-1
Industrial	UL 508
Hazardous Locations	ANSI/ISA 12.12.01-2013 Class I Division 2 Groups A-D ATEX Class I Zone 2 CENELEC EN 60079-0:2012+A11:2013 CENELEC EN 60079-15:2010 IEC 60079-0 Ed 6, Revision Date 2013-11-01 IEC 60079-15 – Edition 4 – Issue Date 2010-01-01
EMI/EMC	FCC Part 15 – Class A CISPR22 :2008 / EN55022:2010 Class A CISPR 24 :2010 / EN55024:2010

Note: The safety certifications apply only to ambient temperatures under 60°C (140°F). However, the IDS-108FPP can function in the environmental conditions listed above.

Note: If the IDS-108FPP is used in environments where ambient temperatures will exceed 60°C (140°F), the IDS-108FPP should be installed in an appropriate enclosure to ensure that no accidental or deliberate contact with the IDS-108FPP is possible. Case temperatures in this ambient could exceed safe levels.

Fiber Specifications

IDS-108FPP models	Fiber Connector (xx)	Mode	Distance	Wavelength (nm)	TX Power (dB)	RX Power (dB)	Budget
IDS-108FPP	None	n/a	n/a	n/a	n/a	n/a	n/a
IDS-108FPP-M2xx2-(XT)	SC/ST	MM duplex	2 km 1.2 miles	TX: 1310 RX:1310	Min:-6 Max:0	Min:-17 Max:0	11
IDS-108FPP-M1SC2U	SC	MM simplex	2 km 1.2 miles)	TX: 1310 RX:1550	Min:-15 Max:8	Min:-28 Max:3	13
IDS-108FPP-M1SC2D	SC	MM simplex	2 km 1.2 miles	TX: 1550 RX:1310	Min:-15 Max:8	Min:-28 Max:3	13
IDS-108FPP-S2xx20-(XT)	SC/ST	SM duplex	20 km 12.4 miles	TX: 1310 RX:1310	Min:-15 Max:8	Min:-34 Max:3	19
IDS-108FPP-S1SC20U-(XT)	SC	SM simplex	20 km 12.4 miles	TX: 1310 RX:1490	Min:-8 Max:3	Min:-22 Max:3	14
IDS-108FPP-S1SC20D-(XT)	SC	SM simplex	20 km 12.4 miles	TX: 1490 RX:1310	Min:-8 Max:3	Min:-22 Max:3	14
IDS-108FPP-S2xx40-(XT)	SC/ST	SM duplex	40 km 24.9 miles	TX: 1310 RX:1310	Min:-3 Max:5	Min:-23 Max:3	20
IDS-108FPP-S1SC40U	SC	SM simplex	40 km 24.9 miles	TX: 1310 RX:1490	Min:-3 Max:2	Min:-23 Max:3	20
IDS-108FPP-S1SC40D	SC	SM simplex	40 km 24.9 miles	TX: 1490 RX:1310	Min:-3 Max:2	Min:-23 Max:3	20
IDS-108FPP-S2xx80	SC/ST	SM duplex	80 km 49.7 miles	TX: 1550 RX:1550	Min: -5 Max: 0	Min-34 Max: -3	29
IDS-108FPP-S2xx120	SC/ST	SM duplex	120 km 74.6 miles	TX: 1550 RX:1550	Min:0 Max:5	Min:-32 Max:-9	32
IDS-108FPP-DM2xx2-(XT) 2 x SC	SC/ST	MM duplex	2 km 1.2 miles	TX: 1310 RX:1310	Min:-6 Max:-0	Min:-17 Max:-0	11
IDS-108FPP-DM1SC2U-(XT) 2 x SC	SC	MM simplex	2 km 1.2 miles	TX: 1310 RX:1550	Min:-15 Max:8	Min:-28 Max:3	13
IDS-108FPP-DM1SC2D-(XT) 2 x SC	SC	MM simplex	2 km 1.2 miles	TX: 1310 RX:1550	Min:-15 Max:8	Min:-28 Max:3	13
IDS-108FPP-DS2SC20 -(XT) 2 X SC	SC	SM duplex	20 km 12.4 miles	TX: 1310 RX:1310	Min:-15 Max:8	Min:-34 Max:3	19

IDS-108FPP-DS2ST20- (XT) 2 X ST	ST	SM duplex	20 km 12.4 miles	TX: 1310 RX:1310	Min:-15 Max:-8	Min:-32 Max:-3	17
IDS-108FPP-DS1SC20U- (XT) 2 x SC	SC	SM simplex	20 km 12.4 miles	TX: 1310 RX:1550	Min:-8 Max:-3	Min:-22 Max:-3	14
IDS-108FPP-DS1SC20D- (XT) 2 x SC	SC	SM simplex	20 km 12.4 miles	TX: 1550 RX:1310	Min:-8 Max:-3	Min:-22 Max:-3	14
IDS-108FPP-DS2xx40- (XT) 2 x SC	SC/ST	SM duplex	40 km 24.9 miles	TX: 1310 RX:1310	Min:-3 Max:-5	Min:-23 Max:-3	20
IDS-108FPP-DS1SC40U 2 x SC	SC	SM simplex	40 km 24.9 miles	TX: 1310 RX:1550	Min:-3 Max:-2	Min:-23 Max:-3	20
IDS-108FPP-DS1SC40D 2 x SC	SC	SM simplex	40 km 24.9 miles	TX: 1550 RX:1310	Min:-5 Max:0	Min:34 Max:-3	20
IDS-108FPP-DS2xx80 2 x SC	SC/ST	SM duplex	80 km 49.7 miles	TX: 1550 RX:1550	Min:-5 Max:0	Min:-34 Max:-3	29
IDS-108FPP-DS2xx120 2 x SC	SC/ST	SM duplex	120 km 74.6 miles	TX: 1550 RX:1550	Min:0 Max:5	Min:-32 Max:-9	32

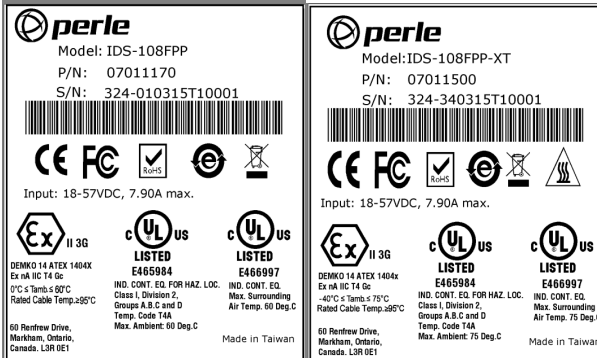

For models IDS-108FPP-xxxxxxx

For models IDS-108FPP-xxxxxxx-XT

Contacting Technical Support

Contact information for the Perle Technical Assistance Center (PTAC) can be found at the link below. A Technical Support Query may be made via this web page.

www.perle.com/support_services/support_request.shtml

Warranty / Registration

http://www.perle.com/support_services/warranty.shtml

Copyright © 2015 Perle Systems Limited. All rights reserved. No part of this document may be reproduced or used in any form without written permission from Perle Systems Ltd.