

ioLogik E4200

Quick Installation Guide

Second Edition, May 2009



© 2009 Moxa Inc. All rights reserved.
Reproduction without permission is prohibited.

Introduction

The ioLogik E4200 comes equipped with 2 Ethernet ports and 1 RS-232 port, making it suitable for remote monitoring and alarm system applications that require multiple I/O points of various types.

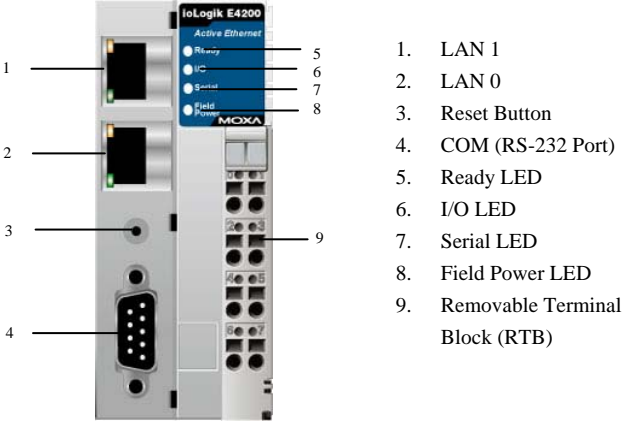

Package Checklist

Moxa's ioLogik E4200 is shipped with the following items. If any of these items are missing or damaged, please contact your customer service representative for assistance.

- 1 ioLogik E4200 Active Ethernet Network Adaptor.
- Quick Installation Guide.
- Software CD with User's Manual and Windows Utility.
- End Module Cover.

Installing the I/O Module on a DIN-Rail

Step1: Align the I/O module side by side with the network adaptor, making sure that the upper and lower rails are hooked together.

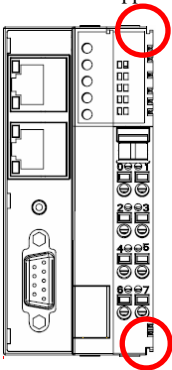

Step 2: Align the I/O module side by side with the network module and then push the I/O module until it touches the DIN-rail. Next, apply more force until the module clips to the DIN-rail.

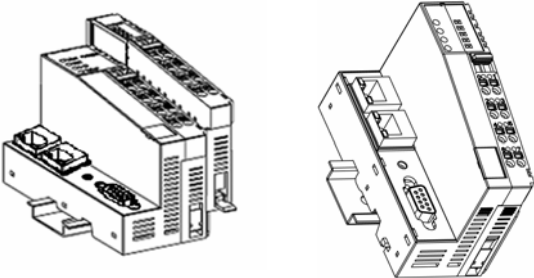

Removing the I/O Module from the DIN-Rail

Step1: Use your finger or a screw driver to pull down the tab on the lower part of the module.

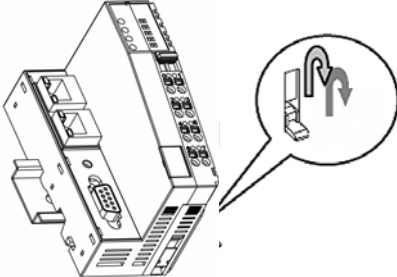

Step2: While still holding down the tab, pull out the Module.

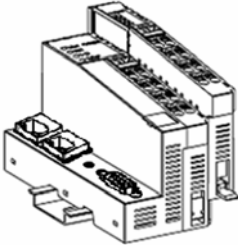

Remove the RTB from the I/O module

Pull out the plastic belt from the RTB, and then apply more force until the I/O module is pulled away from the I/O module.

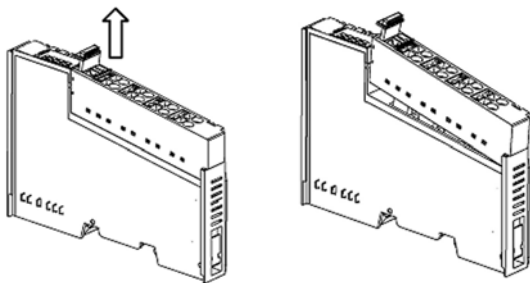

Installing the RTB onto the I/O Module

Step1: Hook the bottom end of the RTB to the I/O module.

Step2: Push down the RTB until it fits snugly on the I/O module, and then push in the plastic belt.

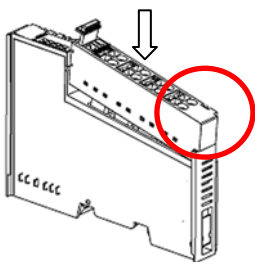

Installing the System Power Module

The system power expansion module is designed to provide extra power when additional I/O expansion modules are connected. Each ioLogik E4200 can provide 1.5A @ 5 VDC. If you require more power for your installed I/O expansion modules, you will need to use an M-7001 module. However, please note that the M-7001 can only provide 1A @ 5 VDC.

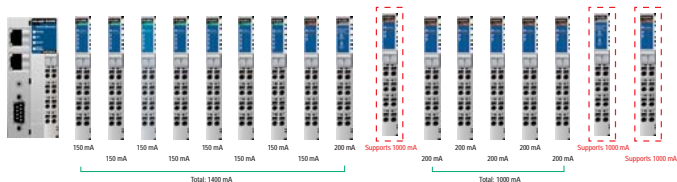

Installing the Field Power Module

The field power distributor is designed to isolate different field voltages. For example, before you connect a 110 VDC or 220 VAC AC-Digital Input module to a 24 VDC DI/O module, you will need an M-7002 field power distributor.

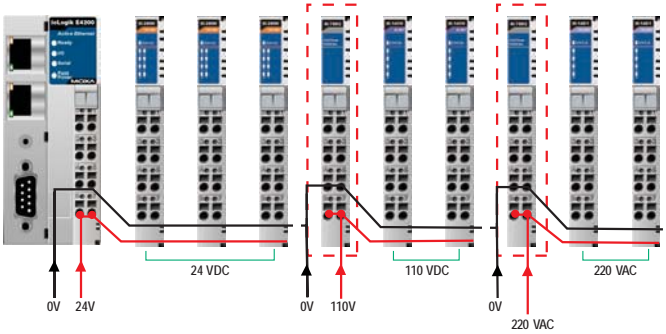

Connecting the Power System

Two 24 VDC power sources are required to power the ioLogic E4200. One 24 VDC power input is for system power, and the other 24 VDC power input is for the field I/O. For field installation, system power and field power are provided by different power supply systems.

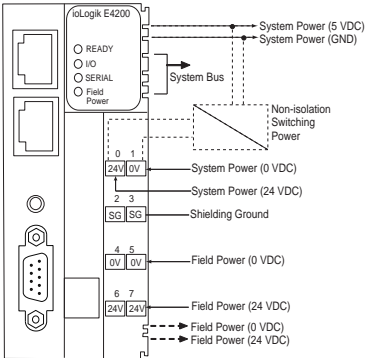

System power:
24 VDC nominal, 11 to 28.8 VDC

Power dissipation:
60 mA @ 24 VDC

Current for I/O module:
1.5A @ 5 VDC

Field power :
11 to 28.8 VDC

Max. current for field power
contact: DC 10A Max.

I/O Cable Gauge:
AWG14 to AWG28

Supported Modules

DC-Digital Input Modules

M-1800	8 digital inputs, sink, 24 VDC, removable terminal block
M-1801	8 digital inputs, source, 24 VDC, removable terminal block
M-1600	16 digital inputs, sink, 24 VDC, 20-pin header
M-1601	16 digital inputs, source, 24 VDC, 20-pin header

AC-Digital Input Modules

M-1450	4 digital inputs, 110 VAC, removable terminal block
M-1451	4 digital inputs, 220 VAC, removable terminal block

Digital Output Modules

M-2800	8 digital outputs, sink, 24 VDC, 0.5A, removable terminal block
M-2801	8 digital outputs, source, 24 VDC, 0.5A, removable terminal block
M-2600	16 digital outputs, sink, 24 VDC, 0.3A, 20-pin header
M-2601	16 digital outputs, sink, 24 VDC, 0.3A, 20-pin header

Relay Output Modules

M-2450	4 Relay outputs, Form A (N.O.), 2A, removable terminal block
--------	--

Analog Input Modules

M-3802	8 analog inputs, 4 to 20 mA, 12-bit, removable terminal block
M-3810	8 analog inputs, 0 to 10V, 12-bit, removable terminal block

Temperature Input Modules

M-6200	2 analog inputs, RTD, removable terminal block
M-6201	2 analog inputs, thermocouple, removable terminal block

Analog Output Modules

M-4402	4 analog outputs, 4 to 20 mA, 12-bit, removable terminal block
M-4410	4 analog outputs, 0 to 10V, 12-bit, removable terminal block

System Modules

M-7001	System expansion power supply, 1.0 A (5 VDC)
M-7002	Field power distributor, 10 A (24/48 VDC, 110/220 VAC)
M-7806	Potential distributor, 8 ch, 4 ch / 24 VDC, 4ch / 0 VDC

Accessories



TB 1600 DIN-rail mounting screw terminal module with 20-pin connector

- 20 pins, one-to-one assignment
- Connector pitch: 3.81 mm
- DIN-rail mounting type
- Dimensions (W x L x H): 77.5 x 67.5 x 51 mm
- RoHS compliant



20-pin to 20-pin flat cable

- Connecting between TB 1600 and ioLogik 4000 series
- Length: 50 cm
- Number of pins: 20



M-8001-PK Removable terminal block

- Terminal block for ioLogik 4000 series
- Packaging: 9 pcs in one box



M-8003-PK Marker with 0 to 9 numbering M-8004-PK Blank marker

- Marker for ioLogik 4000 series
- Packaging: 100 pcs in one box

Technical Support Contact Information **www.moxa.com/support**

Moxa Americas:
Toll-free: 1-888-669-2872
Tel: +1-714-528-6777
Fax: +1-714-528-6778

Moxa China (Shanghai office):
Toll-free: 800-820-5036
Tel: +86-21-5258-9955
Fax: +86-10-6872-3958

Moxa Europe:
Tel: +49-89-3 70 03 99-0
Fax: +49-89-3 70 03 99-99

Moxa Asia-Pacific:
Tel: +886-2-8919-1230
Fax: +886-2-8919-1231