

DA-682C Series Embedded Computer User's Manual

Version 1.0, October 2019

www.moxa.com/product



© 2019 Moxa Inc. All rights reserved.

DA-682C Series Embedded Computer User's Manual

The software described in this manual is furnished under a license agreement and may be used only in accordance with the terms of that agreement.

Copyright Notice

© 2019 Moxa Inc. All rights reserved.

Trademarks

The MOXA logo is a registered trademark of Moxa Inc.
All other trademarks or registered marks in this manual belong to their respective manufacturers.

Disclaimer

Information in this document is subject to change without notice and does not represent a commitment on the part of Moxa.

Moxa provides this document as is, without warranty of any kind, either expressed or implied, including, but not limited to, its particular purpose. Moxa reserves the right to make improvements and/or changes to this manual, or to the products and/or the programs described in this manual, at any time.

Information provided in this manual is intended to be accurate and reliable. However, Moxa assumes no responsibility for its use, or for any infringements on the rights of third parties that may result from its use.

This product might include unintentional technical or typographical errors. Changes are periodically made to the information herein to correct such errors, and these changes are incorporated into new editions of the publication.

Technical Support Contact Information

www.moxa.com/support

Moxa Americas

Toll-free: 1-888-669-2872
Tel: +1-714-528-6777
Fax: +1-714-528-6778

Moxa Europe

Tel: +49-89-3 70 03 99-0
Fax: +49-89-3 70 03 99-99

Moxa India

Tel: +91-80-4172-9088
Fax: +91-80-4132-1045

Moxa China (Shanghai office)

Toll-free: 800-820-5036
Tel: +86-21-5258-9955
Fax: +86-21-5258-5505

Moxa Asia-Pacific

Tel: +886-2-8919-1230
Fax: +886-2-8919-1231

Table of Contents

1. Introduction	1-1
Overview	1-2
Model Descriptions and Package Checklist	1-2
Appearance	1-3
Dimensions	1-4
Features	1-4
Hardware Block Diagram	1-5
DA-682C Basic System	1-5
Hardware Specifications	1-5
2. Hardware Installation	2-1
Installing the Rackmount Ears	2-2
Wiring Requirements	2-3
Connecting the Power	2-4
Wiring the Power Inputs	2-4
Grounding the Chassis	2-5
Power Wiring Methods	2-5
Reset Button	2-6
LED	2-6
Connecting to Displays	2-7
Connecting USB Devices	2-8
Installing a USB Dongle Kit	2-8
Serial Ports	2-9
Gigabit LAN Ports	2-10
Digital Inputs/Digital Outputs	2-11
Relay Output	2-11
Upgrading the Memory Module	2-12
Installing an mSATA Storage Card	2-13
Installing SATA Hard Disks	2-14
Installing the Expansion Module	2-15
3. BIOS Setup	3-1
Entering the BIOS Setup	3-2
Main Page	3-4
Advanced Settings	3-5
Boot Configuration	3-6
SATA Configuration	3-6
Intel® Rapid Storage Technology	3-8
CPU Configuration	3-9
Active Management Technology Support	3-10
Video Configuration	3-11
Chipset Configuration	3-12
SIO ITE8786E	3-13
Console Redirection	3-14
Security Settings	3-15
Current TPM Device	3-15
TPM State	3-15
Clear TPM	3-15
Set Supervisor Password	3-16
Power Settings	3-17
Wake On LAN	3-17
Auto Wake On S5	3-17
Power On USB3 (rear panel)	3-17
Power On USB2 (front panel)	3-18
Power On USB2 (built-in)	3-18
PS/2 Keyboard Power-up	3-18
Boot Settings	3-18
Boot Type	3-18
Network Stack	3-19
PXE Boot capability	3-19
USB Boot	3-19
Timeout	3-19
EFI	3-19
Exit Settings	3-19
Exit Saving Changes	3-20
Save Change Without Exit	3-20
Exit Discarding Changes	3-20
Load Optimal Defaults	3-20
Load Custom Defaults	3-20
Save Custom Defaults	3-20

Discard Changes	3-20
Enable AMT	3-21
Use AMT	3-24
Upgrading the BIOS	3-25
A. Safety Installation Instructions	A-1
1. RTC Battery Warning	A-1
2. Fuse Warning	A-1
3. Rackmount Warning	A-1

Introduction

Thank you for purchasing a Moxa DA-682C industrial computer, a multi-functional embedded computer designed especially for IEC 61850-3 substation automation systems.

This manual covers hardware installation, connector interfaces, and BIOS setup of the DA-682C. For software configuration and management, please refer to the user's manual for your operating system.

The following topics are covered in this chapter:

- ❑ **Overview**
- ❑ **Model Descriptions and Package Checklist**
- ❑ **Appearance**
- ❑ **Dimensions**
- ❑ **Features**
- ❑ **Hardware Block Diagram**
 - DA-682C Basic System
- ❑ **Hardware Specifications**

Overview

The DA-682C computer is built around an Intel® Celeron® or Intel® Core™ i3, i5, or i7 CPU and comes with dual display ports (2 x HDMI), 5 USB ports, 6 gigabit LAN ports, two 3-in-1 RS-232/422/485 serial ports, 6 digital input ports, and 2 digital output ports. The DA-682C is equipped with 2 hot-swappable 2.5" HDD/SSD slots and supports the Intel® RST RAID 0/1 functionality.

Additional value and convenience are provided through a modular design with two independent slots for flexible system integration and expansion. Users have the option to add a variety of different communications modules, including an 8-port RS-232/422/485 module and a 4-port 10/100/1000 Mbps LAN module.

With IEC 61850-3 and IEEE 1613 compliance, the DA-682C is sure to deliver stable and reliable system operation for power applications. It also complies with the IEC 60255 standards, which cover the protection of electrical relays in a smart substation. IEC 60255 is one of the most widely used standards for testing relays and protection equipment, and compliance with the standard ensures that the DA-682C will work reliably and seamlessly with IEDs as part of a robust substation automation system.

EN 50121-4 compliance confirms that the DA-682C can deliver stable and reliable system operations in rail wayside applications, such as station SCADA systems, wayside disaster prevention, traction power, and signaling and safety systems to provide an integrated view of your smart rail setup. The housing is a standard 2U, 19-inch wide, rack mounted rugged enclosure. This robust, rack mountable design provides the hardened protection needed for industrial environment applications.

Model Descriptions and Package Checklist

The DA-682C Series includes the following models:

- **DA-682C-KL1-HH-T:** Intel® Celeron® 3965U, 2C/2T, 2.2 GHz CPU, with 2x HDMI, 6 Gigabit LAN ports, 2 RS/232/422/485 3-in-1 serial port, 2 PS/2, 6 DI/2DO, 1 mSATA, 2 SATA, 6 USB, dual power, -40 to 70°C temp.
- **DA-682C-KL3-HH-T:** Intel® Core™ i3-7100U, 2C/4T, 2.4 GHz CPU, with 2x HDMI, 6 Gigabit LAN ports, 2 RS/232/422/485 3-in-1 serial port, 2 PS/2, 6 DI/2DO, 1 mSATA, 2 SATA, 6 USB, dual power, -40 to 70°C temp.
- **DA-682C-KL5-HH-T:** Intel® Core™ i5-7300U, 2C/4T, 2.6 GHz CPU, with 2x HDMI, 6 Gigabit LAN ports, 2 RS/232/422/485 3-in-1 serial port, 2 PS/2, 6 DI/2DO. 1 mSATA, 2 SATA, 6 USB, dual power, -40 to 70°C temp.
- **DA-682C-KL7-HH-T:** Intel® Core™ i7-7600U, 2C/4T, 2.8 GHz CPU, 2x HDMI, 6 Gigabit LAN ports, 2 RS/232/422/485 3-in-1 serial port, 2 PS/2, 6 DI/2DO, 1 mSATA, 2 SATA, 6 USB, dual power, -40 to 70°C temp.

NOTE Refer to the Component Compatibility Guide (CCG) for the list of components that Moxa has validated to be compatible with this product. You can download the CCG from the Moxa product website. For components with a Moxa P/N, you can order the components together with your product from Moxa and we will install the selected components in your product. Moxa guarantees the compatibility of the components installed in CTO products.

NOTE To order a DA-682C system with preinstalled Debian 9 or Windows 10 Enterprise LTSC 64-bit OS, contact a Moxa sales representative.

Before installing the DA-682C computer, make sure the package contains the following items. If any of these items is missing or damaged, please contact your customer service representative for assistance.

- DA-682C rackmount computer
- Rackmount kit
- Quick Installation Guide (printed)
- Warranty card

Expansion Modules

- **DN-LN04-RJ:** 4-port 10/100/1000 Mbps PCIe LAN module
- **DN-SP08-I-DB:** 8-port RS-232/422/485 serial module with digitally isolated DB9 connector
- **DN-SP08-I-TB:** 8-port RS-232/422/485 serial module with digitally isolated terminal block

Appearance

Front View

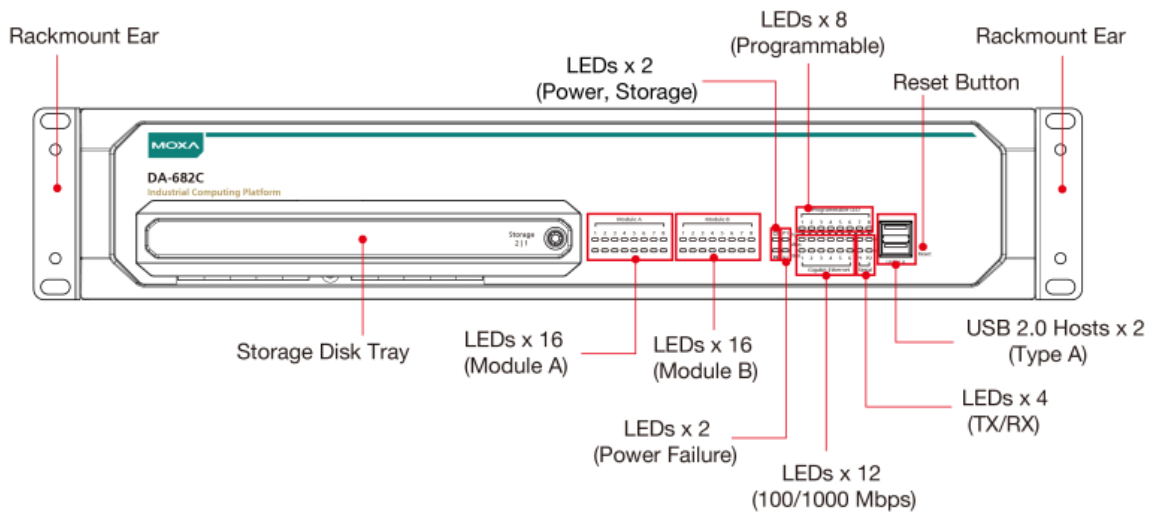

Rear View

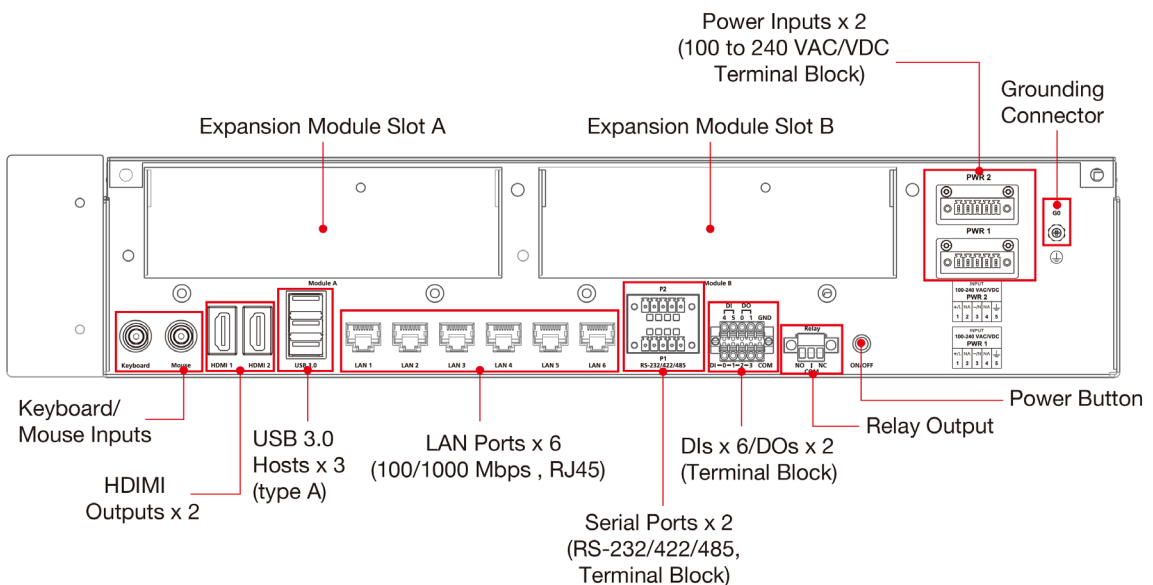

Dimensions

Unit = mm (inch)

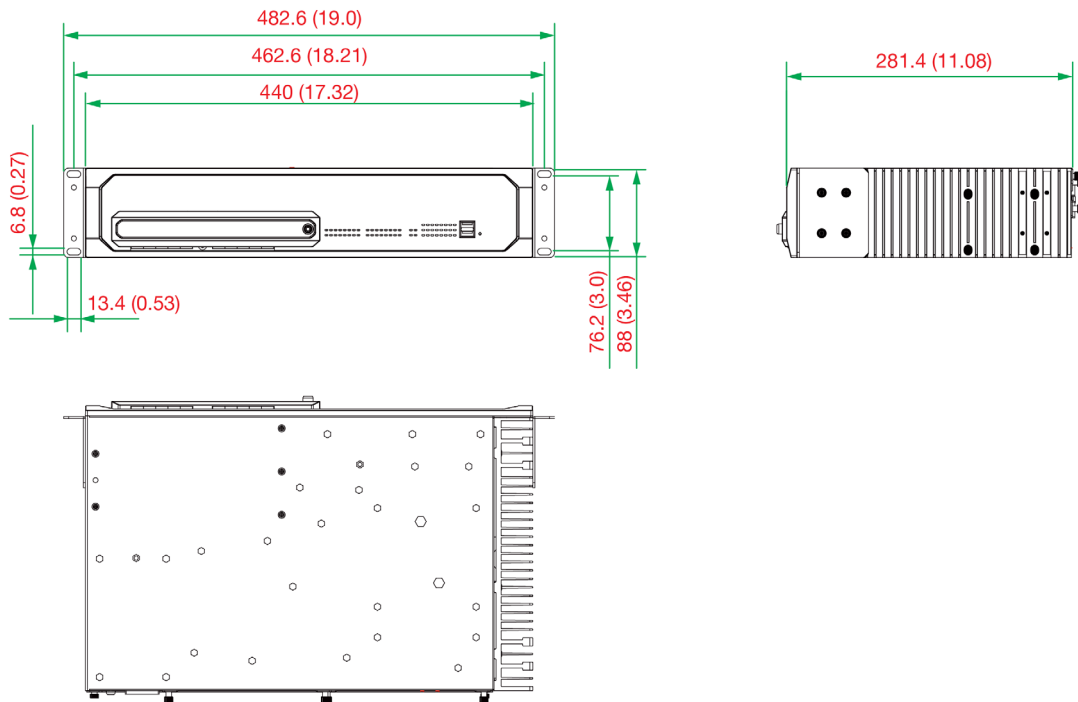

Features

The DA-682C computer has the following features:

- IEC 61850-3, IEEE 1613, and IEC 60255 compliant for power substation automation systems
- 7th Generation Intel® Core™ Processor
- Built-in DDR4 memory slot; up to 32 GB capacity
- Two hot-swappable 2.5-inch HDD or SSD storage expansion trays
- Redundant power supply (100 to 240 VAC/VDC)
- EN 50121-4 compliant for railway wayside applications

Hardware Block Diagram

DA-682C Basic System

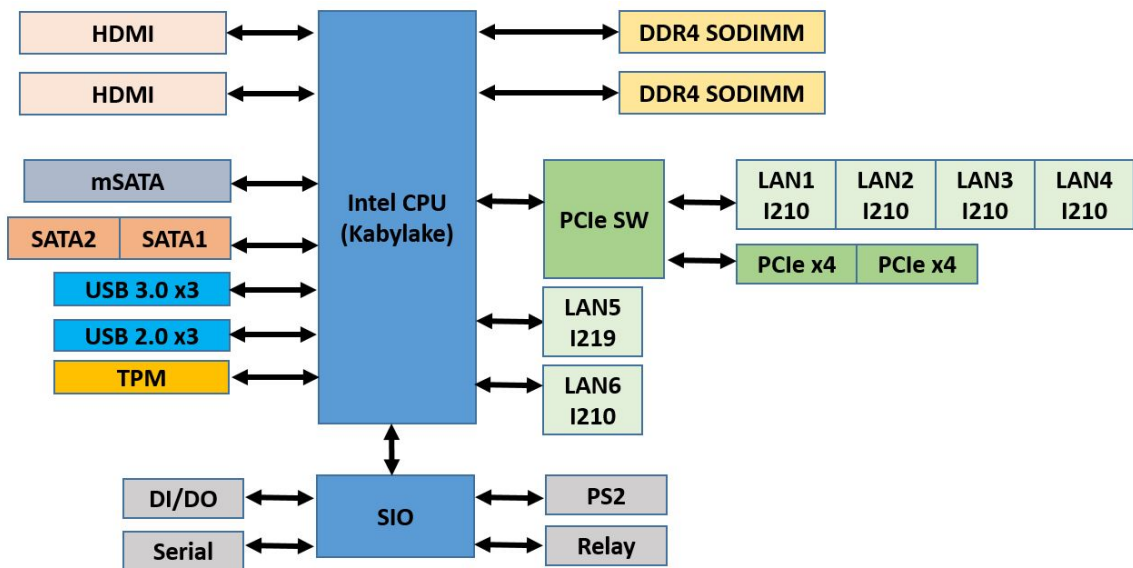

Hardware Specifications

NOTE The latest specifications for Moxa's products can be found at <https://www.moxa.com>.

Hardware Installation

The DA-682C embedded computers are compact and rugged, making them suitable for industrial applications. The LED indicators allow users to monitor performance and identify trouble spots quickly, and multiple ports are provided for connecting a variety of different devices. The DA-682C embedded computers come with a reliable and stable hardware platform that lets you devote the bulk of your time to application development. This chapter describes hardware installation and connector interfaces of the DA-682C embedded computers.

The following topics are covered in this chapter:

- ❑ **Installing the Rackmount Ears**
- ❑ **Wiring Requirements**
- ❑ **Connecting the Power**
- ❑ **Wiring the Power Inputs**
 - Grounding the Chassis
 - Power Wiring Methods
- ❑ **Reset Button**
- ❑ **LED**
- ❑ **Connecting to Displays**
- ❑ **Connecting USB Devices**
 - Installing a USB Dongle Kit
- ❑ **Serial Ports**
- ❑ **Gigabit LAN Ports**
- ❑ **Digital Inputs/Digital Outputs**
- ❑ **Relay Output**
- ❑ **Upgrading the Memory Module**
- ❑ **Installing an mSATA Storage Card**
- ❑ **Installing SATA Hard Disks**
- ❑ **Installing the Expansion Module**

Installing the Rackmount Ears

The DA-682C computer comes with two rackmount kits that allow users to mount the computer on to a rack. Each rackmount kit includes the following items: a rackmount ear and four screws.



Follow these steps to install the rackmount ears.

1. Attach a rackmount ear on the left side of the DA-682C computer, and fasten four screws tightly.
2. Attach the other rackmount ear on the right side of the computer.

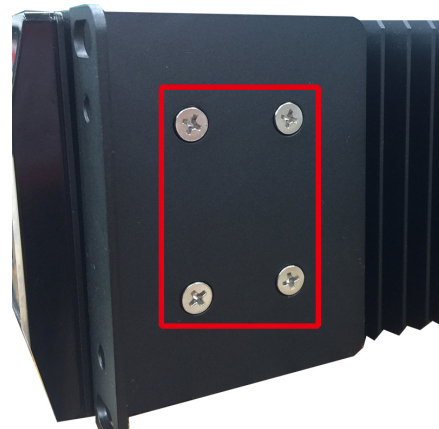
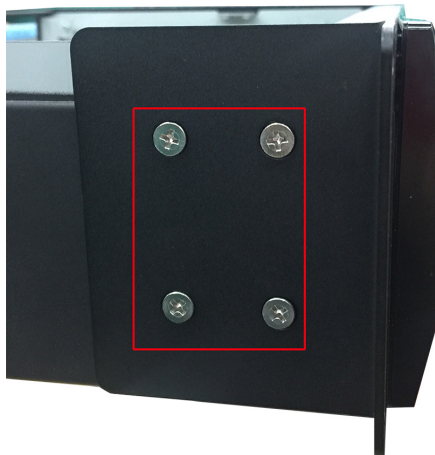

Wiring Requirements

The following common safety precautions should be observed before installing any electronic device:

- Power wires and communication/signal wires should be routed through separate paths. If power and communication/signal wires must cross paths, make sure the wires are perpendicular at the intersection point.
- Use the type of signal transmitted through a wire to determine which wires should be bundled together and which kept separate. The rule of thumb is that wiring that carries similar electrical signals can be bundled together.
- When necessary, we strongly advise labeling the wiring for all devices in the system.



ATTENTION

Do not run signal or communication wiring and power wiring in the same wire conduit. To avoid interference, wires with different signal characteristics should be routed separately.



ATTENTION

Safety First!

Be sure to disconnect the power cord before installing and/or wiring your device.

Electrical Current Caution!

Calculate the maximum possible current in each power wire and common wire. Observe all electrical codes dictating the maximum current allowable for each wire size.

If the current goes above the maximum rating, the wiring could overheat, causing serious damage to your equipment.

Temperature Caution!

Be careful when handling the unit. When the unit is plugged in, the internal components generate heat, and consequently the outer casing may feel hot to the touch.



Restricted Access Location

This equipment is intended to be used in Restrict Access Location, like computer room. The access can only be gained by SERVICE PERSONS or by USERS who have been instructed about the metal chassis of the equipment is so hot that service persons have to pay special attention or take special protection before touching it. Further, the access is through the use of key or security identity system. Only authorized by well trained professional person can access the restrict access location.



External metal parts are hot!! Before touching it, special attention or protection is necessary.

Connecting the Power

The DA-682C provides dual power inputs using a terminal block, which is located on the rear panel. Connect the power cord wires to the screws, and then tighten the screws. The Power LED will light up to indicate that power is being supplied to the DA-682C, after which the BIOS will initialize the flash disk module, causing the Storage LED to blink. It should take about 30 to 60 seconds for the operating system to complete the boot up process.

Wiring the Power Inputs

The DA-682C computers come with single power input and dual power inputs models. Refer to the following diagrams and table for a detailed description of the power input wiring. The terminal numbers referred to in the table are shown in the diagrams below.

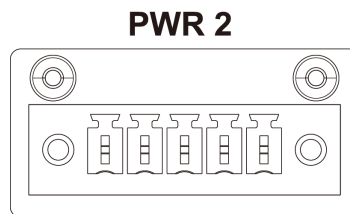
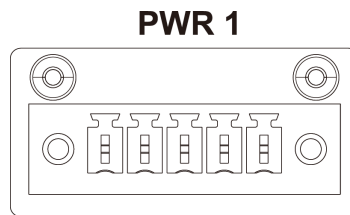

INPUT 100-240 VAC/VDC PWR 1				
+ / L	NA	- / N	NA	⏏
1	2	3	4	5

INPUT 100-240 VAC/VDC PWR 2				
+ / L	NA	- / N	NA	⏏
1	2	3	4	5

Terminal Number	Description	Note
1	Power Line	PWR Line is connected to the Line (L) terminal for the AC power source.
	Power Positive	PWR Positive is connect to the Positive (+) terminal for the DC power source
2	NA	No function
3	Power Neutral	PWR Neutral is connected to the Neutral (N) terminal for the AC power source.
	Power Negative	PWR Negative is connect to the Negative (-) terminal for the DC Power
4	NA	No function
5	Bond Earth	Bond Earth is connected to the Chassis Ground via a jumper on the terminal block.

Grounding the Chassis

There is a grounding connector located on the rear panel of the computer.

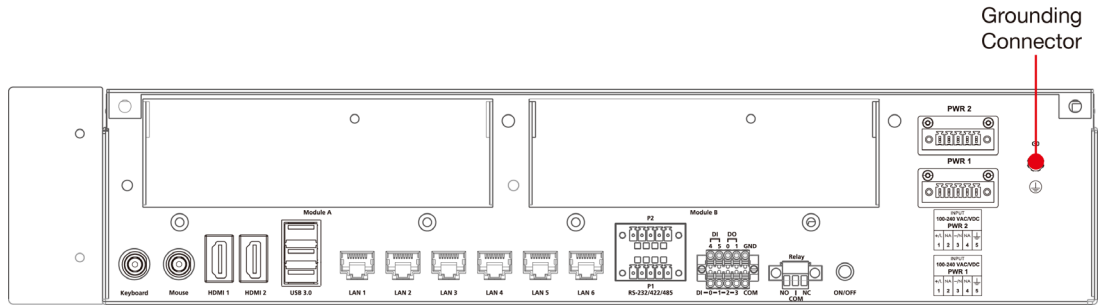

Connect the connector to the chassis ground source.

G0

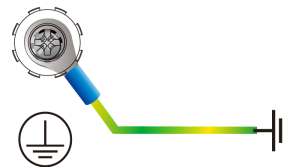

⚠ ATTENTION

If protective earthing is used as a safeguard, the instructions shall require connection of the equipment protective earthing conductor to the installation protective earthing conductor (for example, by means of a power cord connected to a socket-outlet with earthing connection).

Power Wiring Methods

The DA-682C comes with single or dual power inputs; both AC and DC power sources are supported. Refer to the following diagrams for detailed wiring methods.

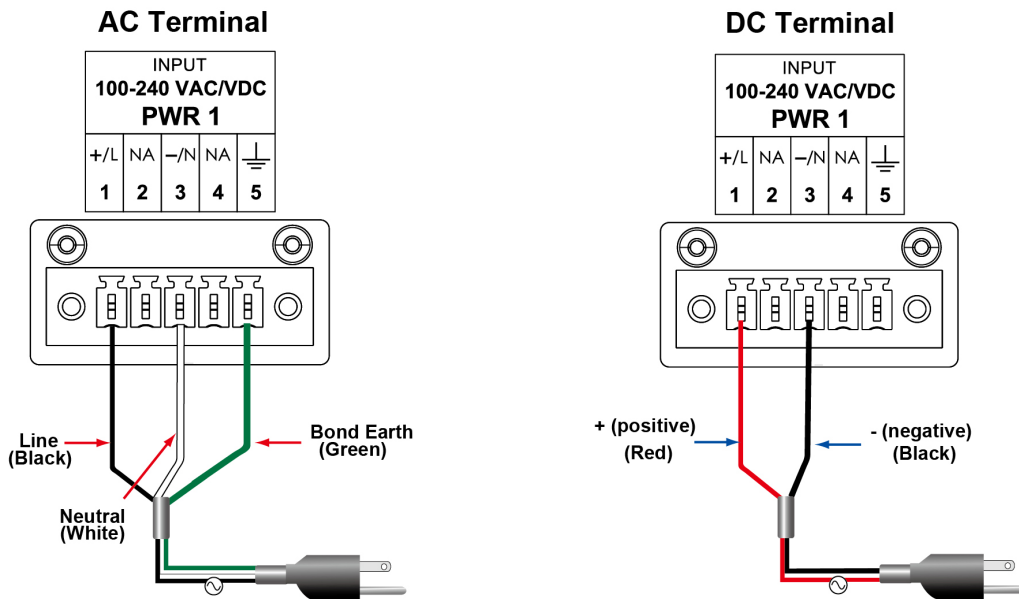

⚠ ATTENTION

Equipment must be installed according to the applicable country's wiring codes.

In addition, there is a power button on the rear panel, which allows users to power on the computer in case the computer is in the sleep or hibernate mode.

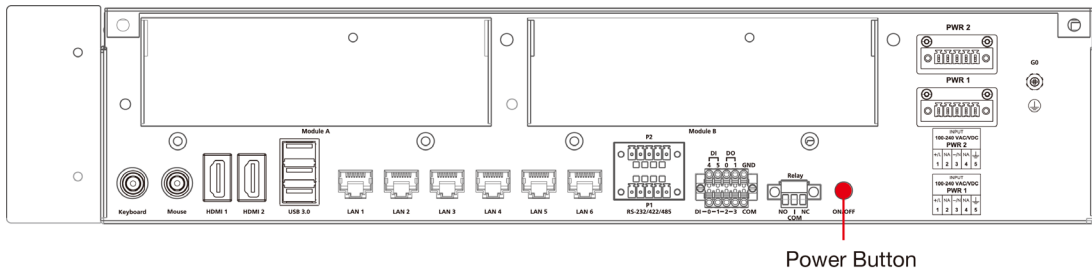

Reset Button

Pressing the Reset button initiates a hardware warm reboot. The button plays the same role as a desktop PC’s reset button. After pressing the reset button, the system will reboot automatically. During normal use, you should NOT use the Reset Button. You should only use this button if the software is not working properly. To protect the integrity of data being transmitted or processed, you should always reset the system from the operating system using the software reboot function.

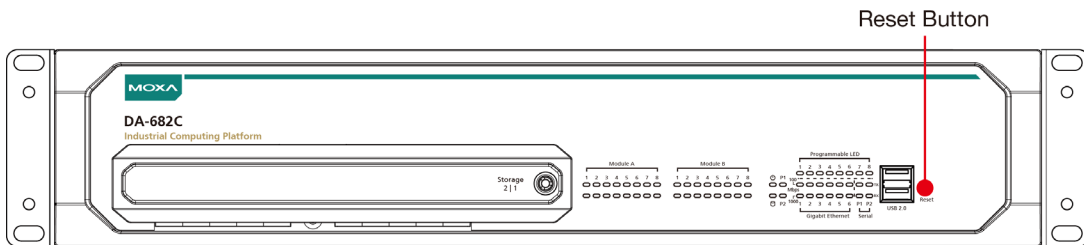

LED

There are 60 LED indicators on the front panel.

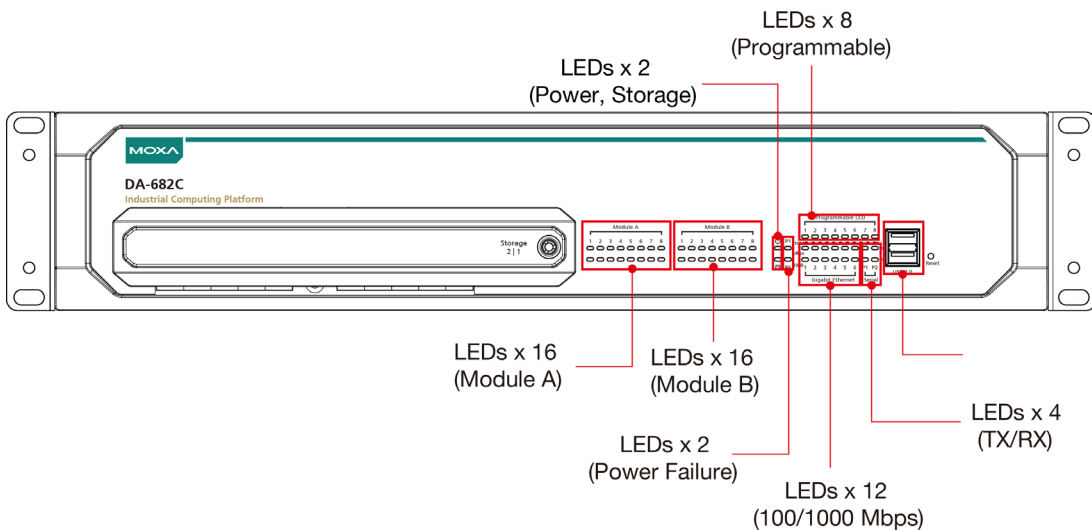

Information about each LED indicator is given in the following table.

LED	Color	Description
Power	Green	Power is on
	Off	No power input
Storage	Yellow/Blinking	Data is being written to or read from the storage unit
	Off	Storage unit is idle
Power 1 Failure	Off	The 1 st power supply is on
	Red	Error in the 1 st power supply
Power 2 Failure	Off	The 2 nd power supply is on
	Red	Error in the 2 nd power supply
Gigabit LAN LEDs 1 to 6	Green	100 Mbps Ethernet mode
	Orange	1000 Mbps (Gigabit) Ethernet mode
Serial Port P1/P2 (TX/RX)	Green	Tx: Serial data is being transmitted
	Yellow	Rx: Serial data is being received
Programmable LEDs 1 to 8	Green/ Blinking	Can be used to indicate statuses or for debugging, as defined by users.
Module LEDs 1 to 8 (Module A/Module B)	Green/Orange/ Blinking	Reserved for LAN-port and serial-port expansion cards.

Connecting to Displays

The DA-682C comes with 2 HDMI interfaces on the rear panel, allowing users to connect two displays.

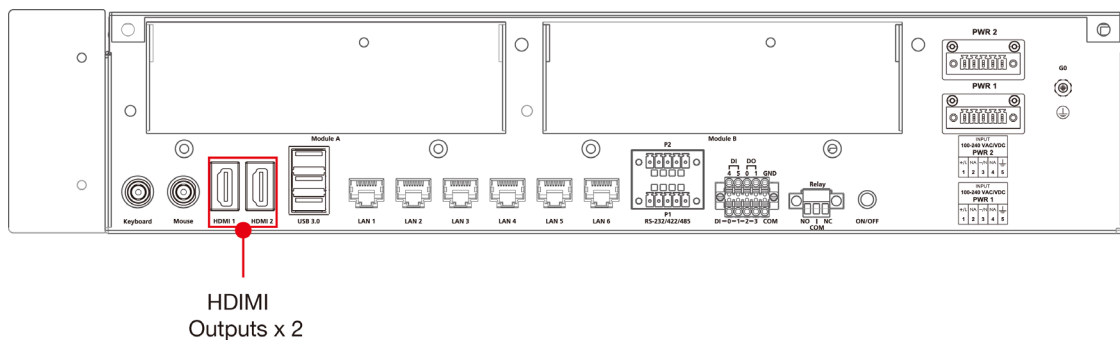

NOTE In order to have a highly reliable video streaming capability, choose certified HDMI cables.

Connecting USB Devices

The DA-682C comes with 2 USB 2.0 ports on the front panel and 3 USB 3.0 ports on the rear panel. The USB ports can be used to connect to other peripherals, such as flash drives for expanding the system’s storage capacity. In addition, both USB ports support system boot up, which can be activated by modifying the BIOS settings. See **Chapter 3: BIOS Setup** for details.

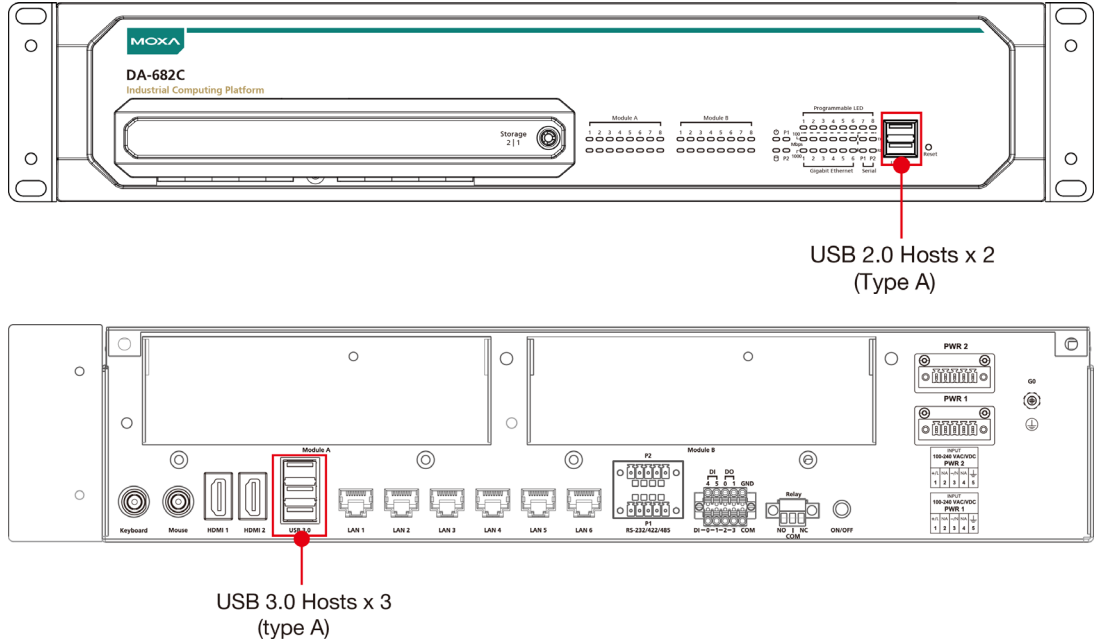

Installing a USB Dongle Kit

You can use a USB Dongle Kit to secure your USB dongle inside your DA-682C computer.

NOTE The USB Dongle Kit is an optional accessory that can be purchased separately.

To install a USB Dongle Kit inside your DA-682C computer, do the following:

1. Power off the DA-682C computer and remove the upper cover of the computer. Find the location of the USB socket.

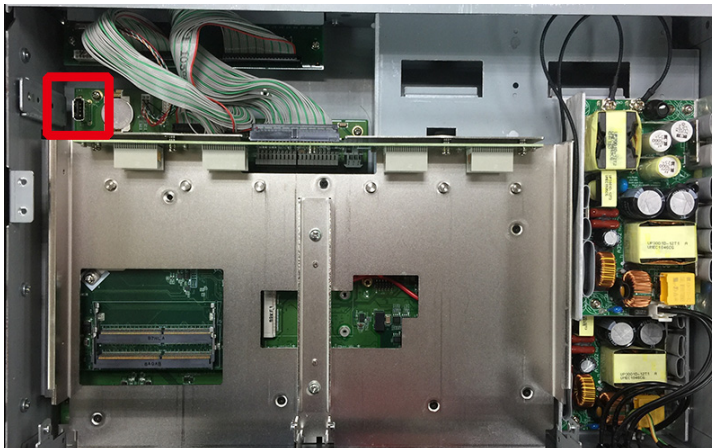

- 2. The USB Dongle Kit includes a USB plate and a screw.

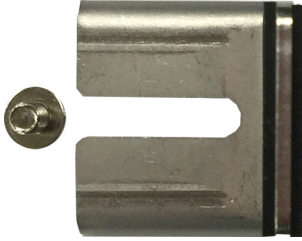

- 3. Attach the USB device to the USB port inside the DA-682C computer.
- 4. Place the USB plate on the rail, and push down to the USB device as close as possible. Finally, fasten the screw on the plate.

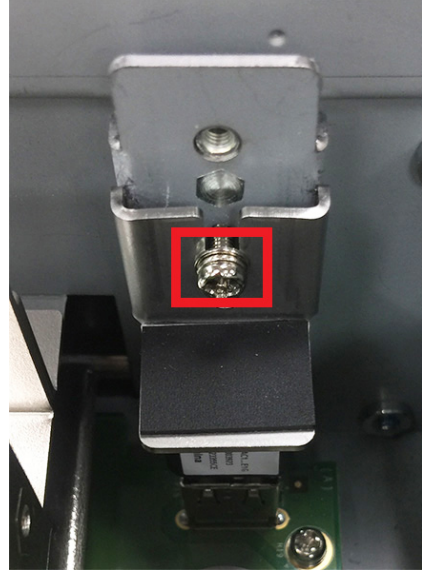
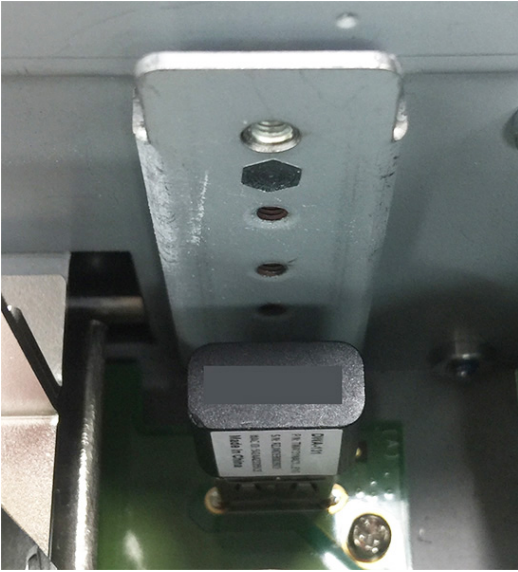

- 5. Replace the upper cover of the computer.

Serial Ports

The DA-682C comes with 2 software-selectable RS-232/422/485 serial ports on the rear panel.

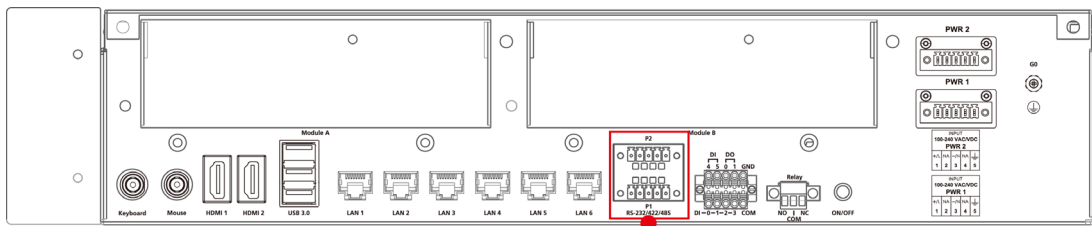

Serial Ports x 2
(RS-232/422/485, Terminal Block)

The ports use terminal blocks. Refer to the following table for the pin assignments:

Pin	RS-232	RS-422	RS-485 (4-wire)	RS-485 (2-wire)
1	TxD	TxD(+)	TxD(+)	-
2	RxD	TxD(-)	TxD(-)	-
3	RTS	RxD(+)	RxD(+)	Data(+)
4	CTS	RxD(-)	RxD(-)	Data(-)
5	GND	GND	GND	GND

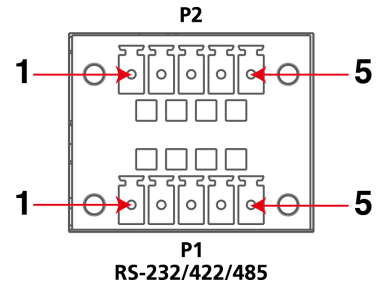

Gigabit LAN Ports

The DA-682C has 6 Gigabit LAN ports. When a LAN cable is properly connected, the LEDs on the front panel will glow to indicate a proper connection.

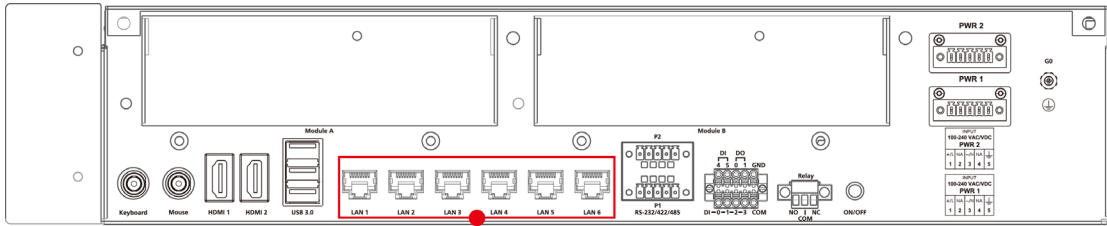

LAN Ports x 6
(100/1000 Mbps , RJ45)

Refer to the following figure and table for the pin sequence and definitions.

Pin	100 Mbps	1000 Mbps
1	Tx+	TRD(0)+
2	Tx-	TRD(0)-
3	Rx+	TRD(1)+
4	-	TRD(2)+
5	-	TRD(2)-
6	Rx-	TRD(1)-
7	-	TRD(3)+
8	-	TRD(3)-

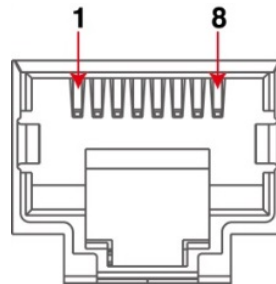

Digital Inputs/Digital Outputs

The DA-682C comes with six digital inputs and two digital outputs in a terminal block. Refer to the following figure for the location of the DI/DO connectors.

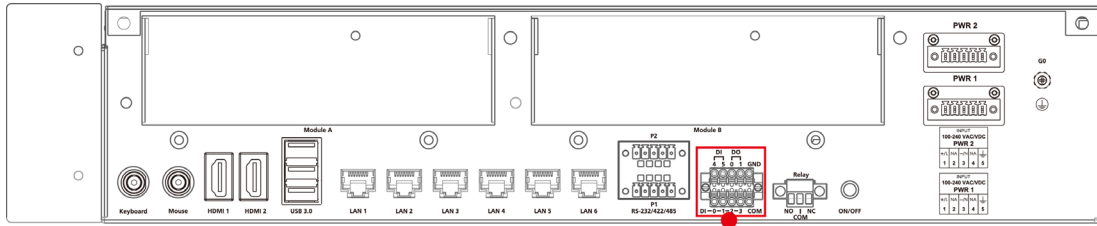

DI's x 6/DO's x 2
(Terminal Block)

For pin definitions and wiring methods, see the figures below.

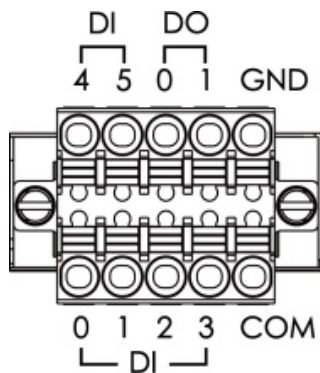

Digital Input

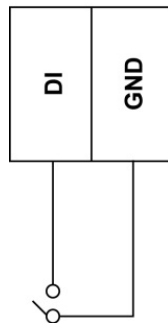

Digital Output

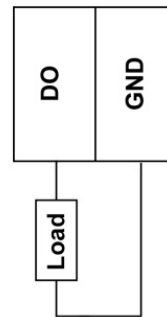

Relay Output

The DA-682C provides a relay output located on the rear panel of the computer.

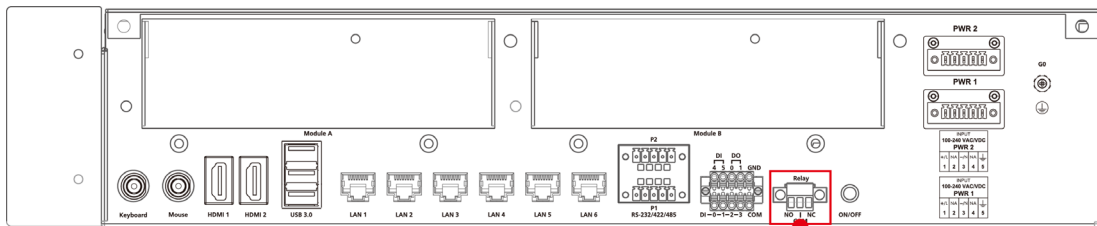

Relay Output

Refer to the figure on the right for detailed pin definition of the relay output connectors.

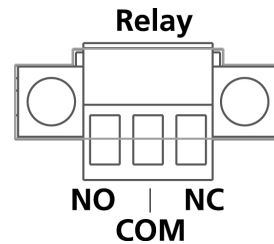

Upgrading the Memory Module

The DA-682C embedded computer supports 2 ECC registered DDR3 1333/1600 SODIMM modules, for up to 16 GB of memory (2 slots, each with 8 GB). To upgrade the SDRAM memory module, follow these instructions:

1. Disconnect the DA-682C from its power source.
2. Unfasten the screws on the back of the computer, and then take off the upper cover.

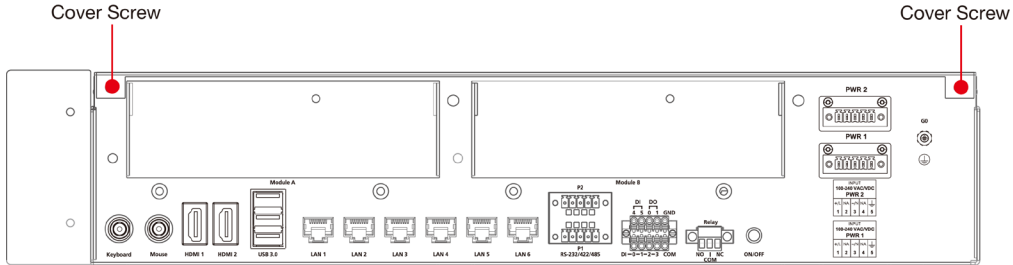

3. Find the location of the SDRAM memory socket.

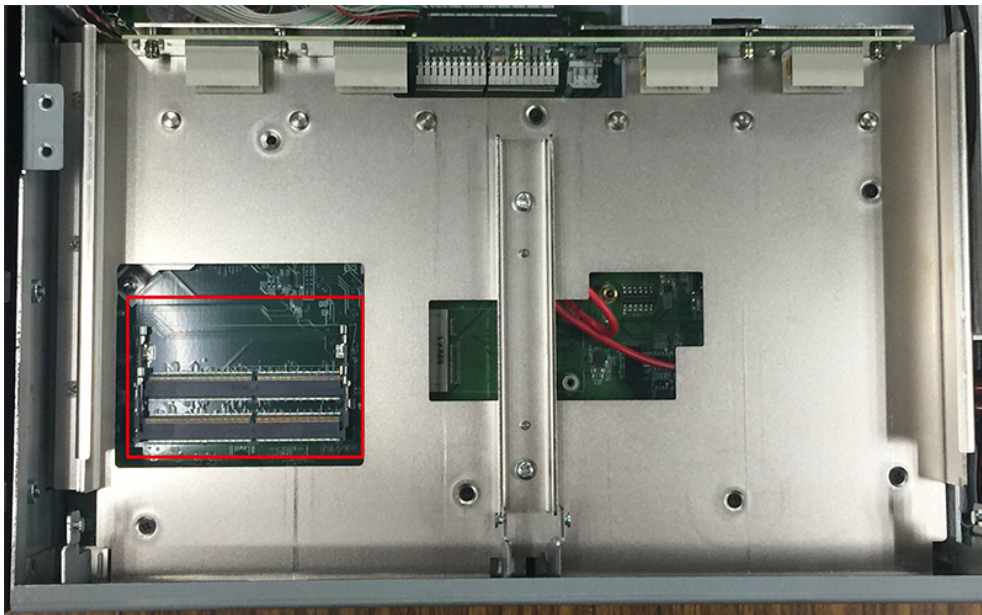

If a memory module is already installed in the socket, push the two fasteners to free and then remove the module.

4. Insert the new memory module into the socket, making sure you insert the SDRAM in the correct direction. Push down the memory module, making sure that the two fasteners snap in place and are holding the module firmly.

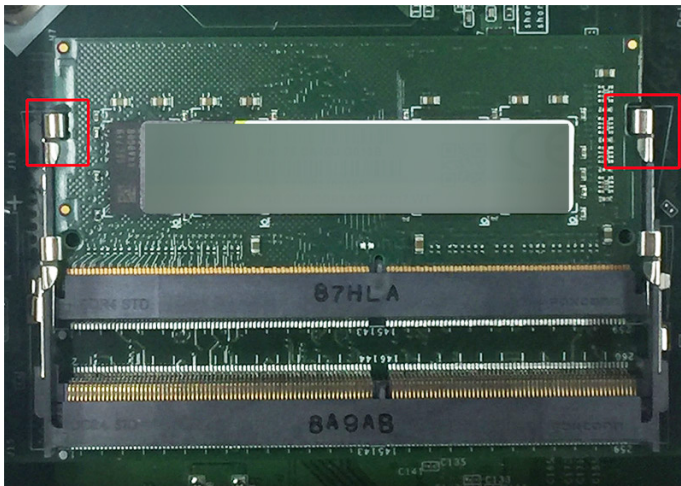

5. When finished, replace the upper cover of the computer and fasten the screws.

Installing an mSATA Storage Card

The DA-682C embedded computer comes with an mSATA socket. To insert an mSATA storage card, follow these instructions.

1. Disconnect the DA-682C from its power source.
2. Unfasten the screws on the back of the computer, and then take off the upper cover.

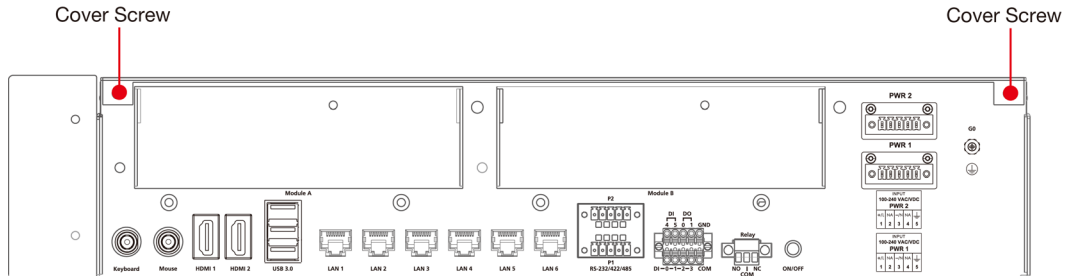

3. Unfasten the two screws on the metal bar in the middle of the cabinet. The mSATA socket is located below.

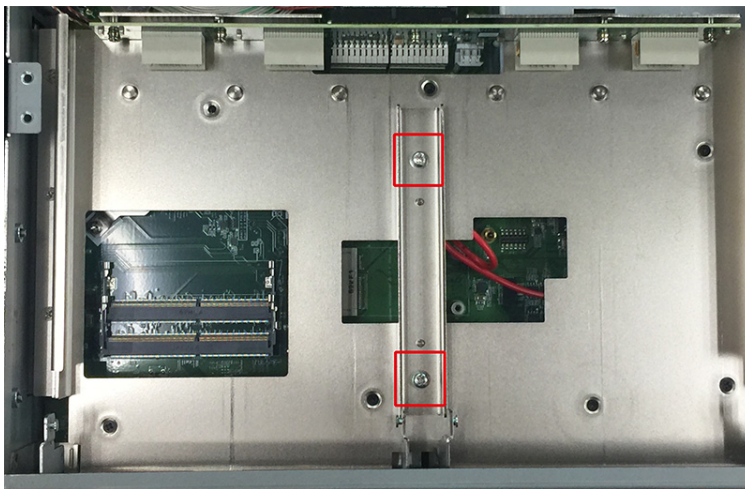

4. Insert the mSATA storage card into the socket, and fasten the two screws to fix the card.

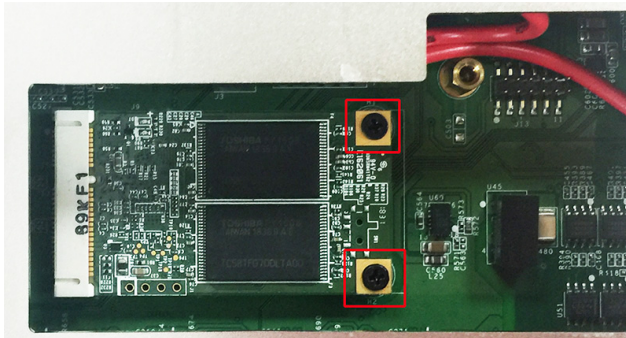

5. When finished, restore the metal bar, the upper cover of the computer and fasten the screws.



ATTENTION

The DA-682C rackmount computer does not support the mSATA storage card hot swap and PnP (Plug and Play) functions. It is necessary to remove power source first before inserting or removing the mSATA storage card.

Installing SATA Hard Disks

The DA-682C comes with two SATA slots that allow users to install two 2.5" SATA HDD/SSD in the computer. Follow these steps to install a SATA disk.

1. Unfasten the screw on the storage disk tray, and pull down the tray door.

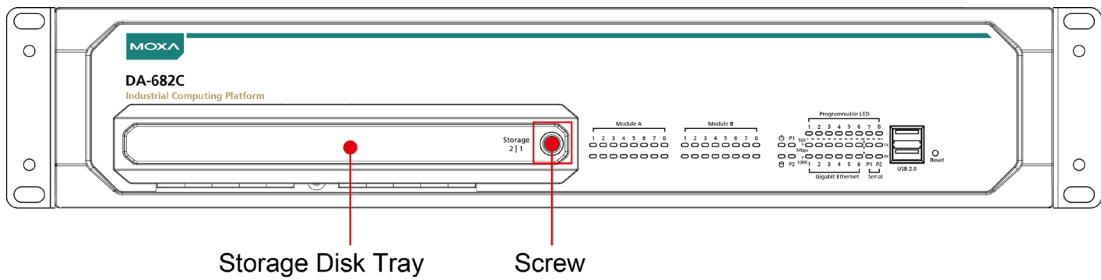

2. There are two disk trays available. The right tray is Storage 1, while the left one is Storage 2. To take out the disk tray, push the clutch to the left.

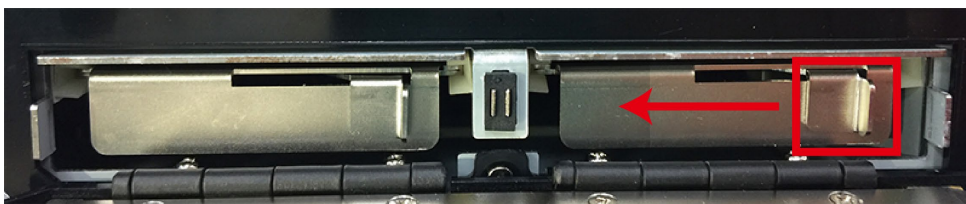

3. Place the SATA disk on the tray.

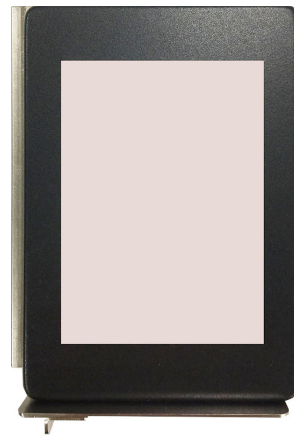

4. Turn back to the rear side of the tray, and fasten four screws. See the following diagram for details.



- There are two plastic rails inside the slot. Make sure to insert the storage tray into the rails.

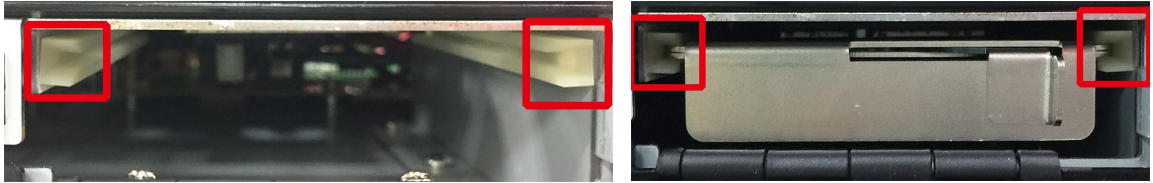

- Push the disk tray into the computer; make sure the storage tray has been successfully inserted. Use the same method to install another disk if necessary.
- Restore the storage tray door to complete.

Installing the Expansion Module

The DA-682C comes with two expansion sockets, allowing users to install various expansion modules such as Gigabit Ethernet module and serial communication module. Follow these steps.

- Unfasten the two screws on each module plate, and then remove the plate.

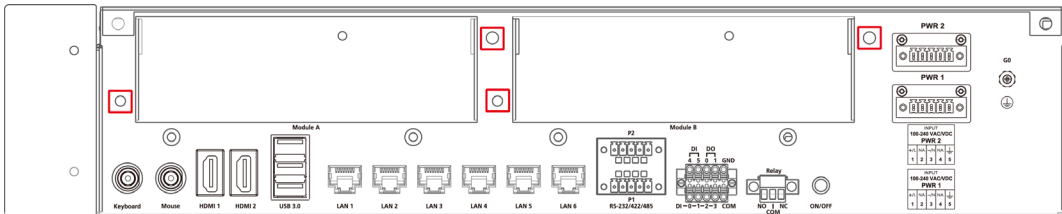

- Insert the expansion module into the slot.

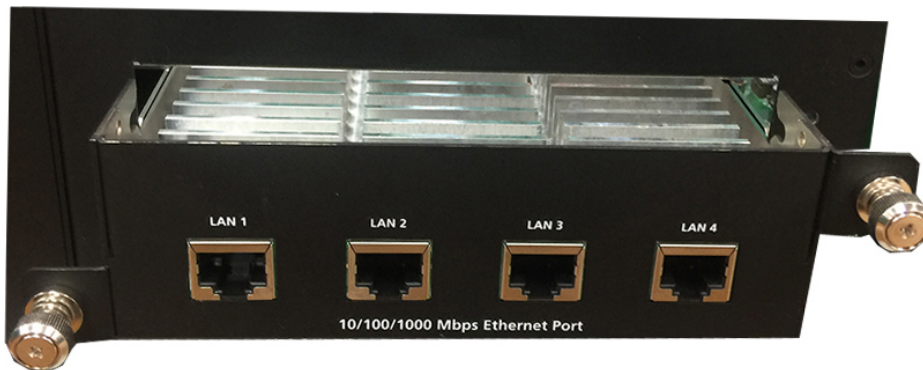

- Make sure the module has been successfully inserted. Fasten the screws to complete.

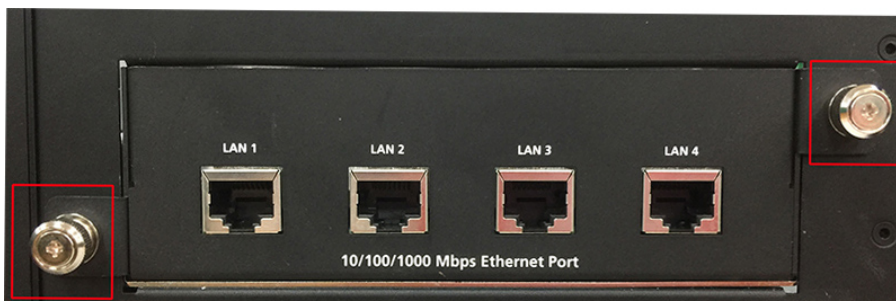

ATTENTION

Please ensure to power off the computer first and then install/remove the expansion modules.

BIOS Setup

This chapter describes the BIOS settings of the DA-682C computer. The BIOS is a set of input/output control routines for peripherals, and is used to initialize system peripherals before the operating system is loaded. The BIOS setup allows the user to modify the system configurations of these peripherals' basic input/output.

The following topics are covered in this chapter:

❑ Entering the BIOS Setup

❑ Main Page

❑ Advanced Settings

- Boot Configuration
- SATA Configuration
- Intel® Rapid Storage Technology
- CPU Configuration
- Active Management Technology Support
- Video Configuration
- Chipset Configuration
- SIO ITE8786E
- Console Redirection

❑ Security Settings

- Current TPM Device
- TPM State
- Clear TPM
- Set Supervisor Password

❑ Power Settings

- Wake On LAN
- Auto Wake On S5
- Power On USB3 (rear panel)
- Power On USB2 (front panel)
- Power On USB2 (built-i
- PS/2 Keyboard Power-up

❑ Boot Settings

- Boot Type
- Network Stack
- PXE Boot capability
- USB Boot
- Timeout
- EFI

❑ Exit Settings

- Exit Saving Changes
- Save Change Without Exit
- Exit Discarding Changes
- Load Optimal Defaults
- Load Custom Defaults
- Save Custom Defaults
- Discard Changes

❑ Enable AMT

❑ Use AMT

❑ Upgrading the BIOS

Entering the BIOS Setup

To enter the BIOS setup utility, press the **F2** while the system is booting up. The main **BIOS Setup** screen will appear. Five options will be available:

- **Continue:** Continue to boot up
- **Boot Manager:** Select the device for booting up
- **Device Management:** Enter the device configuration menu
- **Boot From File:** Select the UEFI boot up file
- **Setup Utility:** Enter the BIOS configuration menu
- **Intel® Management Engine BIOS Extension:** Enter the AMT configuration menu

Select **F2** to enter the **BIOS configuration**.

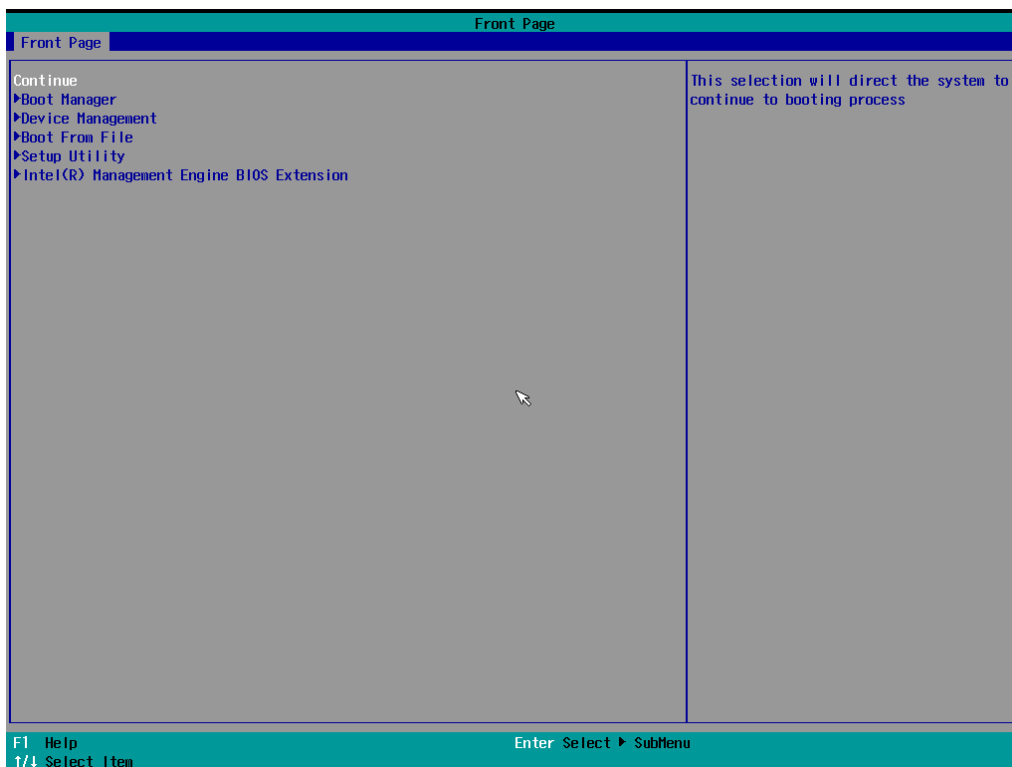

When you enter **Setup Utility**, a basic description of each function key is listed at the bottom of the screen. Refer to these descriptions to learn how to use them.

F1	General Help	↑/↓.	Select Item
F5/ F6	Change Values	←/→	Select Menu
F9	Setup Defaults	ESC	Exit
F10	Save and Exit	ENTER	Select or go to Submenu.

The BIOS configuration screen will be shown when you enter the **Setup Utility** option, as shown in the following figure.

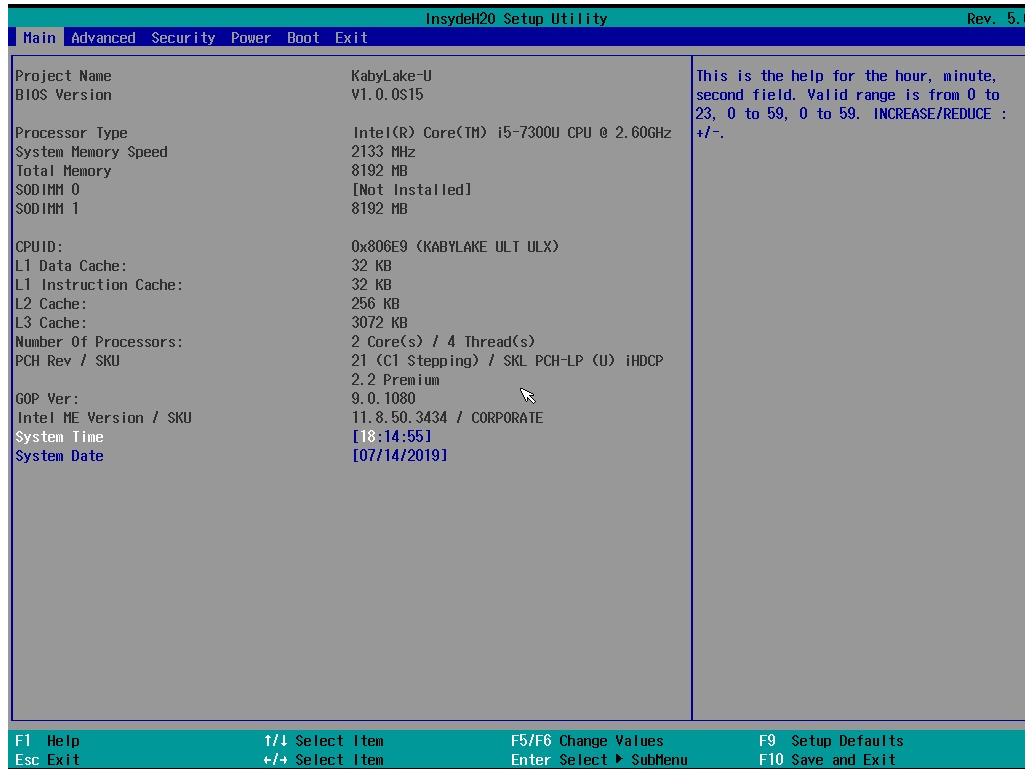

Note that the **Processor Type** information for will vary depending on which model you purchased.

Main Page

The **Main** page displays basic system hardware information, such as model name, BIOS version, and CPU type.

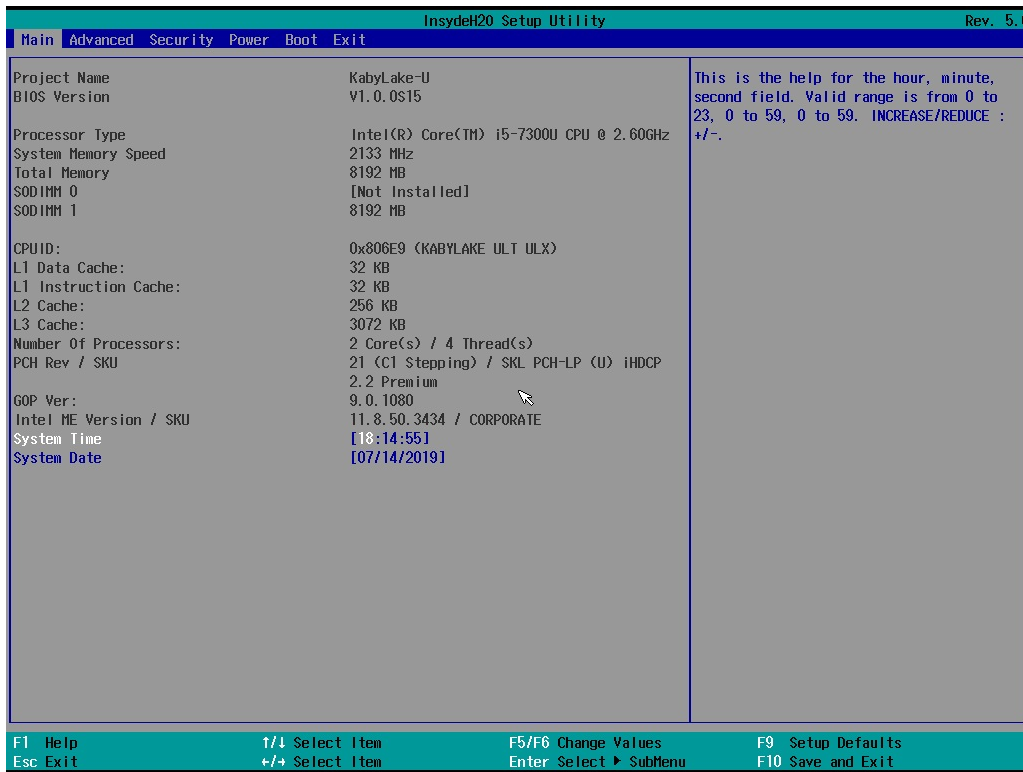

Advanced Settings

Select the "Advanced" option in the main menu to open the "Advanced Features" screen.

NOTE The Active Management Technology is not supported in the DA-682C-KL1 and DA-682C-KL3 models.

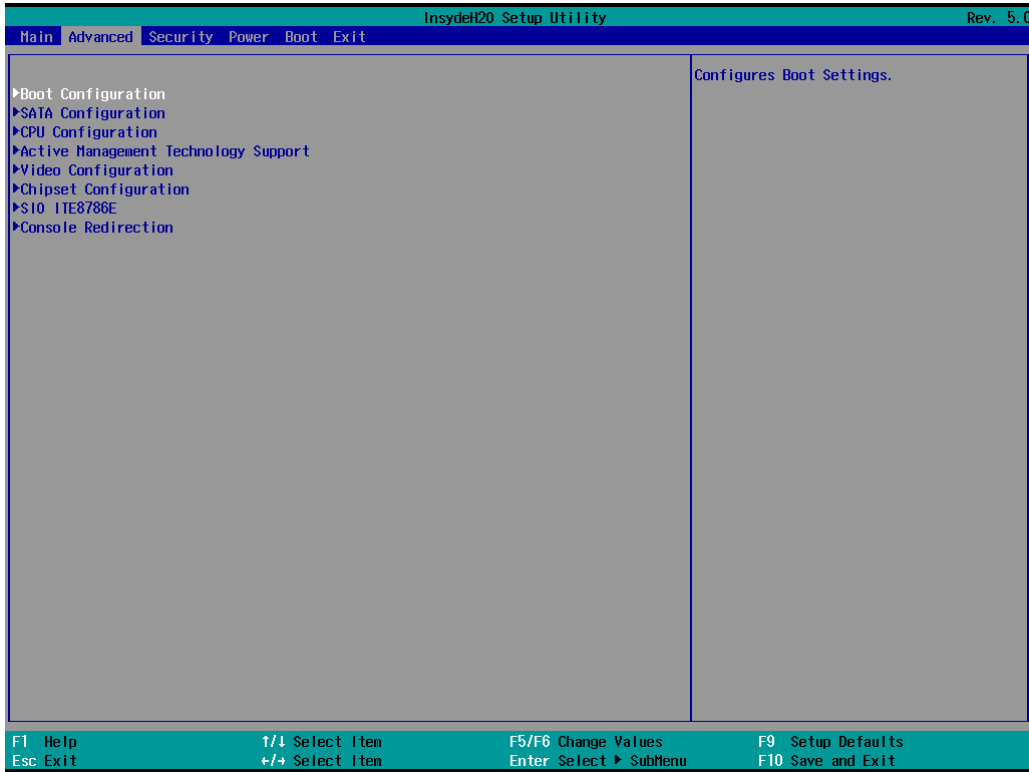

Boot Configuration

This item allows users to configure the default value of Numlock.

Options: On (default), Off.

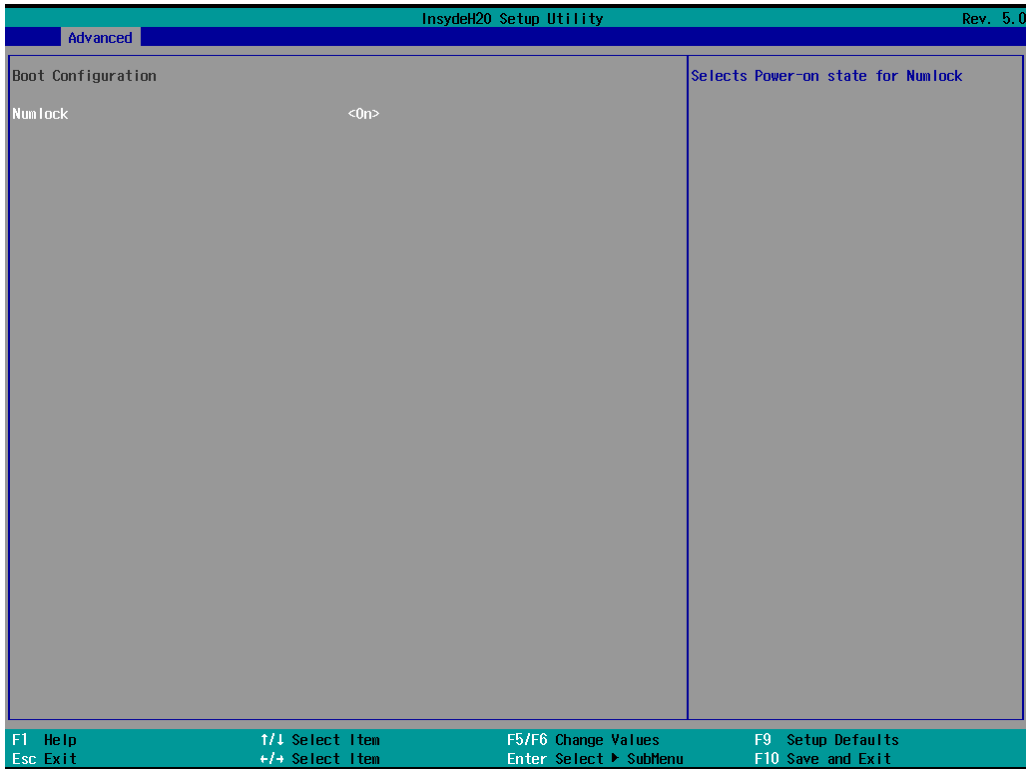

SATA Configuration

The host drive controller can be configured for AHCI (default) or Intel RST Premium mode.

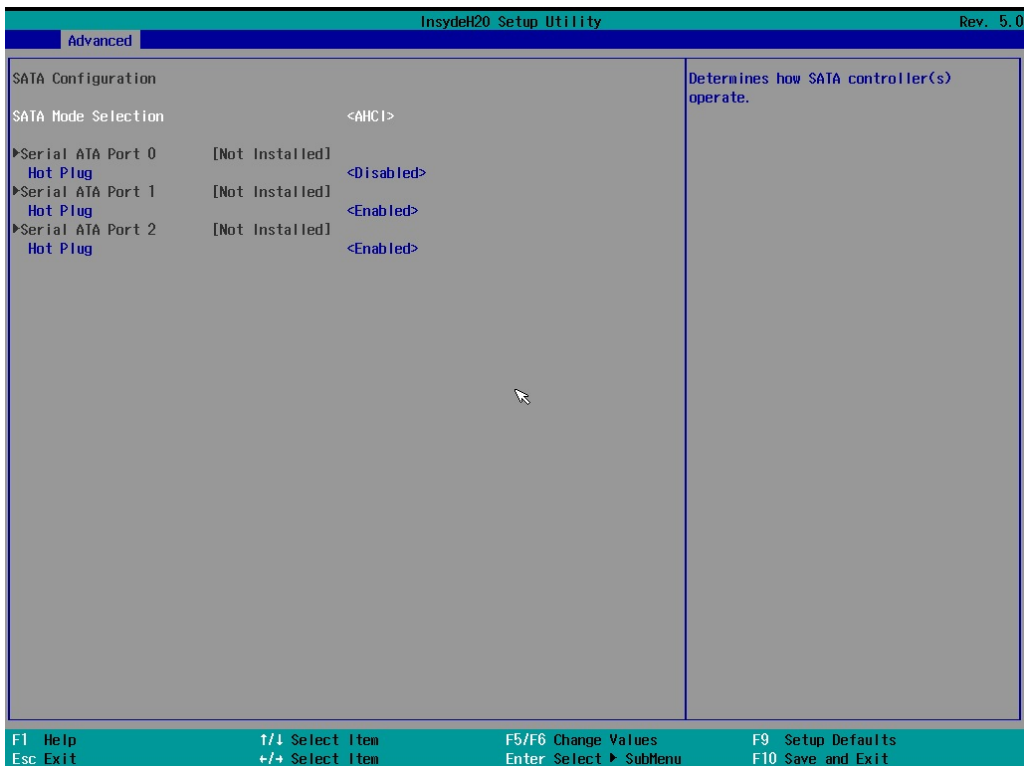

Serial ATA Port

This setting displays the information about the installed drives.

SATA Port—HotPlug

This item allows you to enable/disable hot-plugging capabilities (the ability to remove the drive while the computer is running) for installed storage drives.

Options: Disabled (default for Port 0), Enabled (default for Port 1 and Port 2)

RAID

Set HDC configuration as "Intel RST Premium" to enable **redundant array of inexpensive disks** technology. The DA-682C has three SATA interfaces, which only supports RAID levels 0, 1, and Recovery.

Recovery utilizes RAID 1 (mirroring) functionality to copy data from a designated master drive to a designated recovery drive. The master drive data can be copied to the recovery drive either continuously or on request.

When using the continuous update policy, changes made to the data on the master drive while the system is not docked are automatically copied to the recovery drive when the system is re-docked. When using the on request update policy, the master drive data can be restored to a previous state by copying the data on the recovery drive back to the master drive.

Source: http://en.wikipedia.org/wiki/Standard_RAID_levels for details.

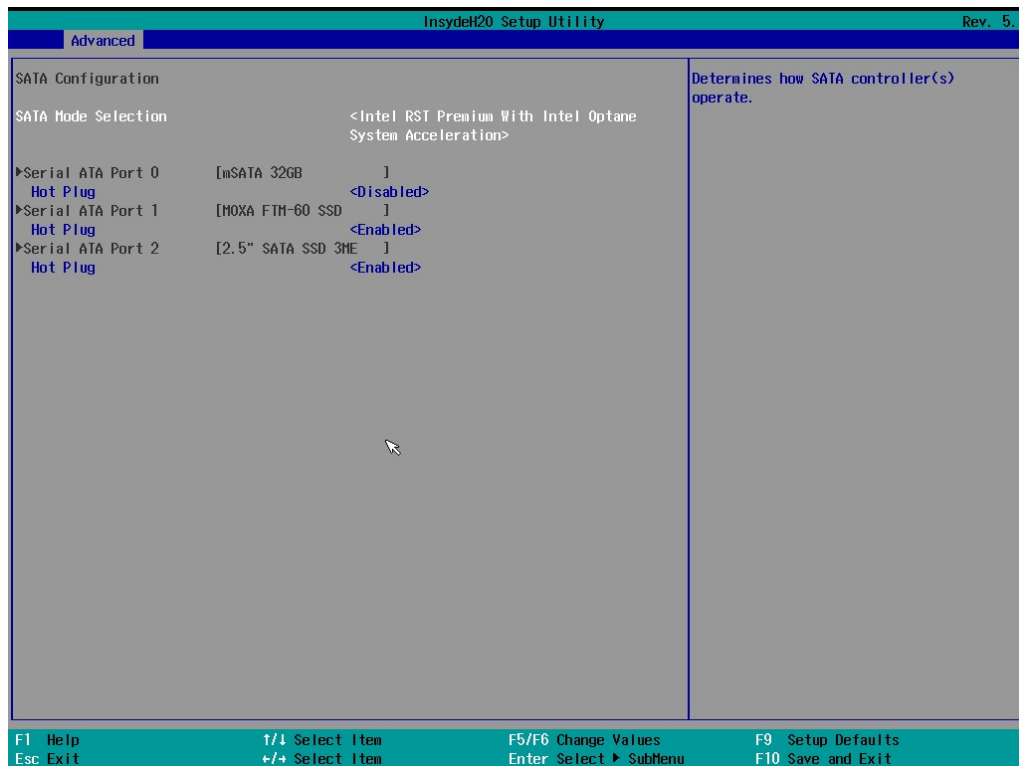

When setting the Intel RST Premium mode, or saving changes and reboot, you can select **Device Management** to configure the following Intel Rapid Storage Technology.

Intel® Rapid Storage Technology

Select **Device Management** on the BIOS main page and then select the **Intel® Rapid Storage Technology** option.

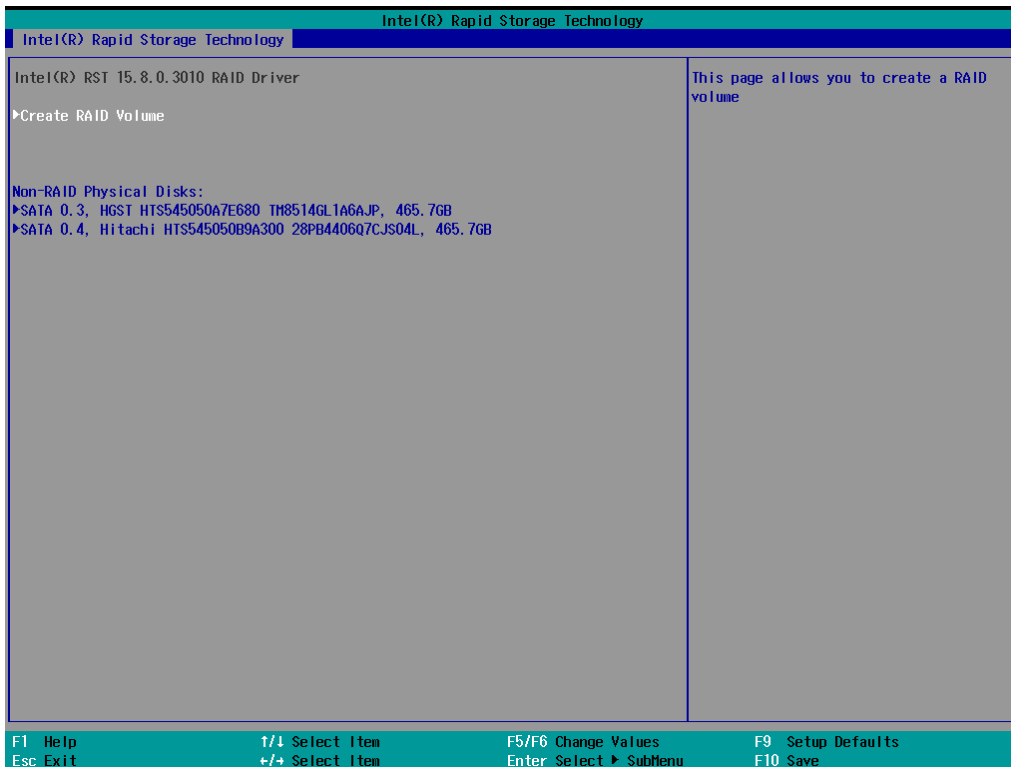
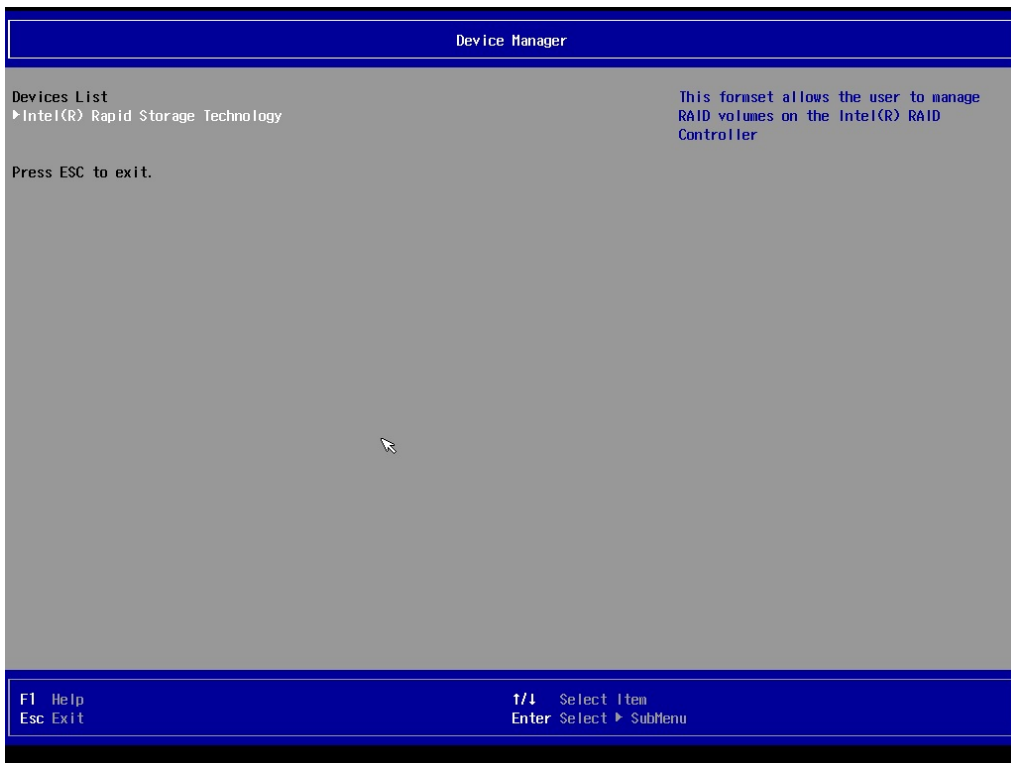

CPU Configuration

NOTE Hyper-Threading is not supported in the DA-682C-KL1 and DA-682C-KL3 models.

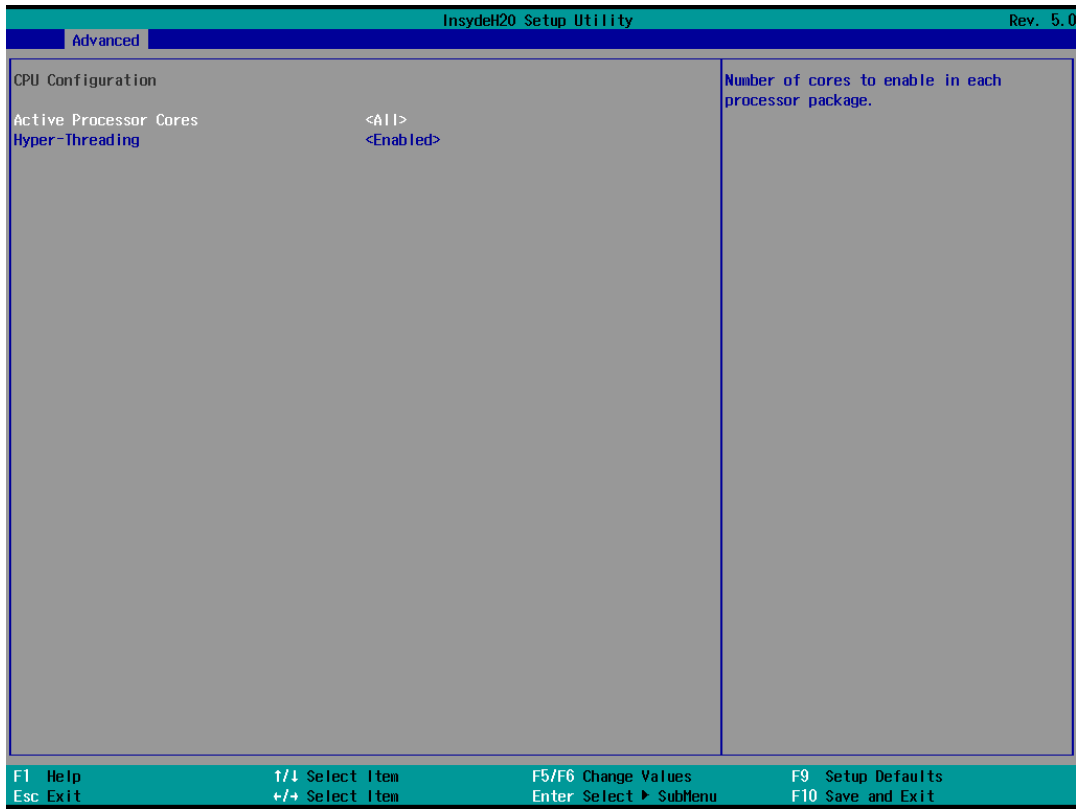

Active Processor Cores

This item indicates the number of cores to enable in each processor package.

Hyper-threading

This feature makes the processor resources work more efficiently, enabling multiple threads to run on each core. It also increases processor throughput, improving overall performance on threaded software.

Options: Disabled, Enabled (default)

Active Management Technology Support

This item allows you to configure the Intel® Active Management Technology.

NOTE The DA-682C-KL3 model does not support this function.

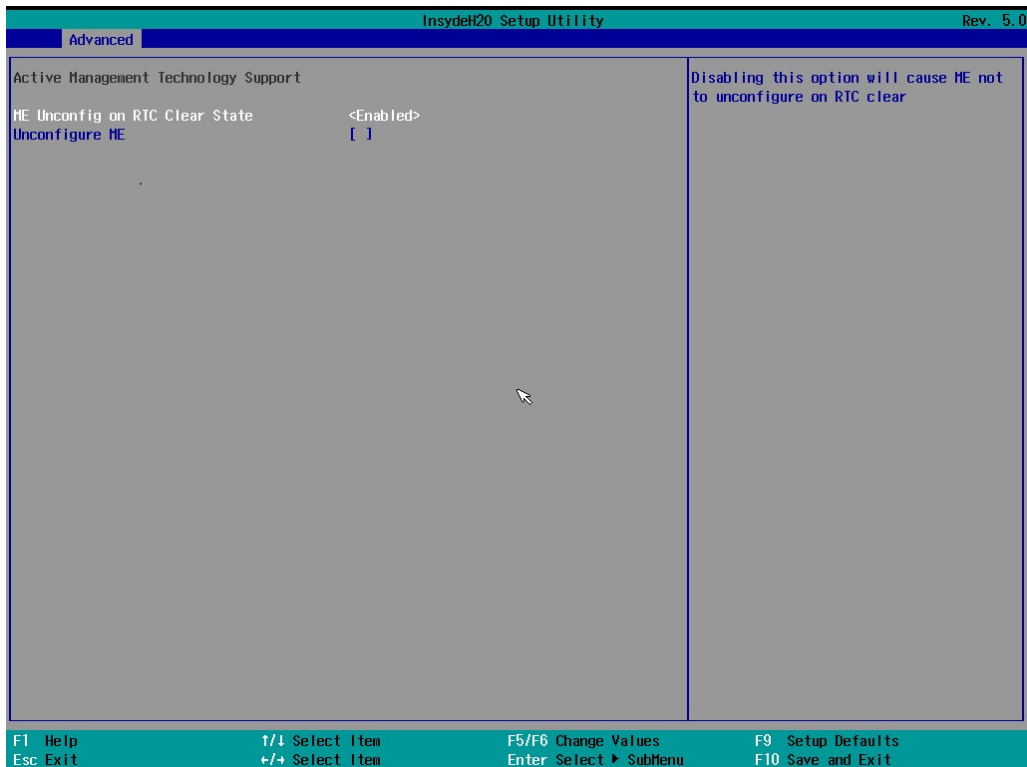

ME Unconfig on RTC Clear State

Disabling this option will cause ME not to unconfigure on RTC clear.

Options: Disabled, Enabled (default)

Unconfigure ME

Unconfigure ME with resetting MEBx password to default.

Video Configuration

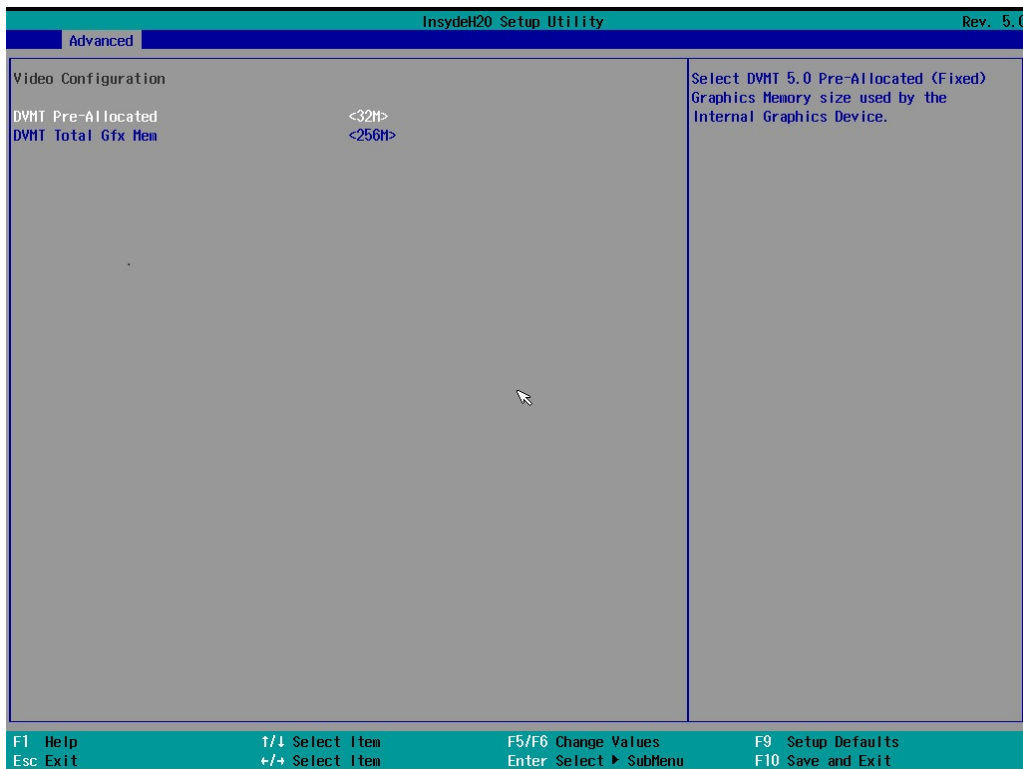

DVMT Pre-Allocated

This item allows you to configure pre-allocated memory capacity for the IGD. Pre-allocated graphics memory is invisible to the operating system.

Options: 12 M, 16M, 20M, 24M, 28M, 32M (default), 36M, 40M, 44M, 48M, 52M, 56M, 60M, 64M

DVMT: The amount of video memory your computer has is dependent on the amount of pre-allocated memory set for your system plus the Dynamic Video Memory Technology (DVMT). DVMT dynamically allocates system memory for use as video memory creating the most efficient use of available resources for maximum 2D/3D graphics performance.

DVMT Total Gfx Memory Size

This item allows you to configure the maximum amount of memory DVMT will use when allocating additional memory for the internal graphics device.

Options: 256 MB (default), 128 MB, Max.

Chipset Configuration

This item allows you to configure the chipset settings.

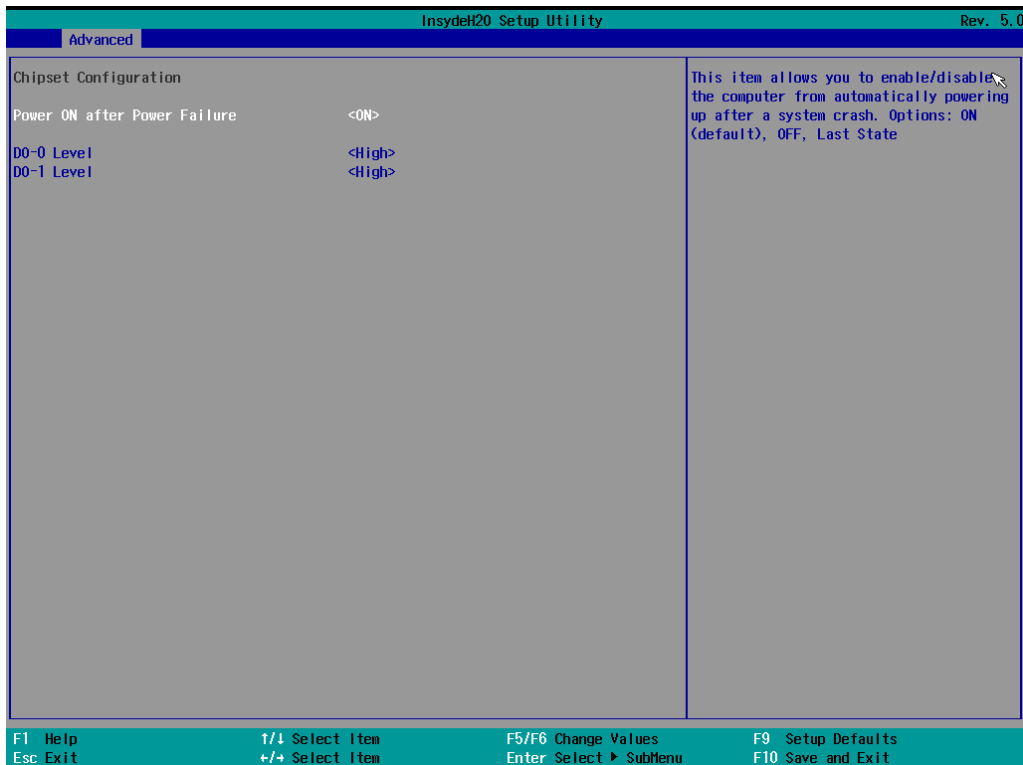

Power ON after Power Failure

This item allows you to enable/disable the computer from automatically powering up after system power is re-enabled.

Options: ON (default), OFF, Last State

DO-0 Level

This item allows users to set the DO 0 as high or low.

Options: High (default), Low

DO-1 Level

This item allows users to set the DO 1 as high or low.

Options: High (default), Low

SIO ITE8786E

This section allows users to configure serial port settings.

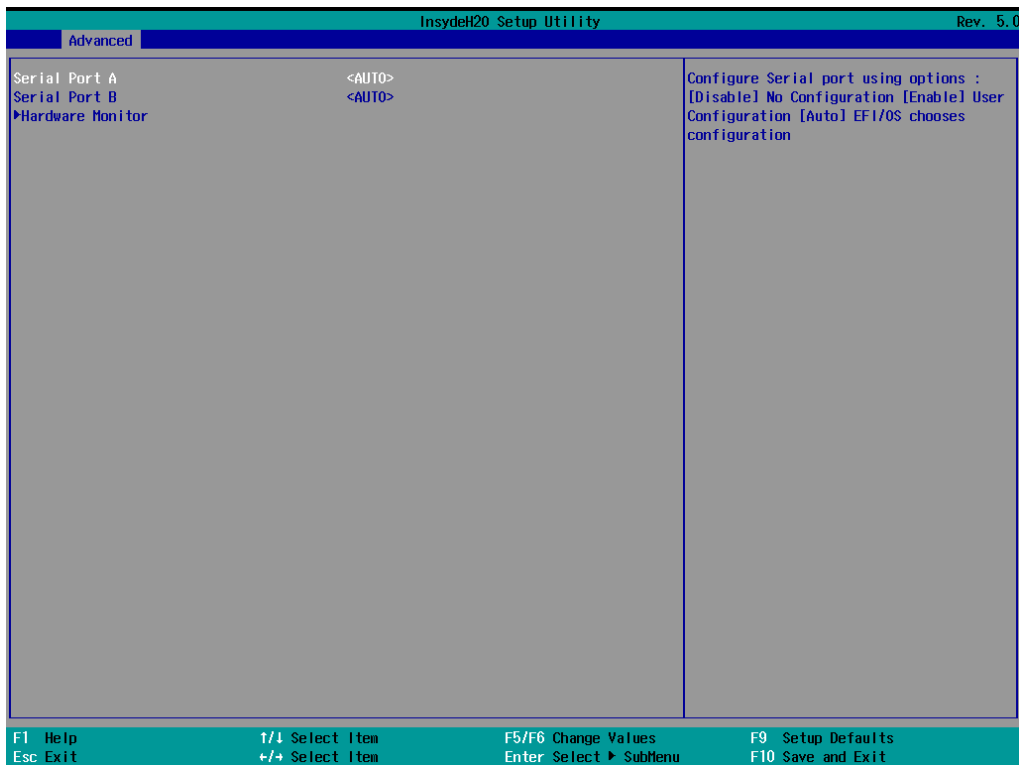

Serial Port A

This function allows users to configure the resources for serial port A.

Disable: No resources

Enable: User configures the resources

Auto (default): EFI/OS chooses the resources

Serial Port B

This function allows users to configure the resources for serial port B.

Disable: No resources

Enable: User configures the resources

Auto (default): EFI/OS chooses the resources

Hardware Monitor

This item allows you to view stats such as CPU and system temperature, voltage levels, and other chipset information.

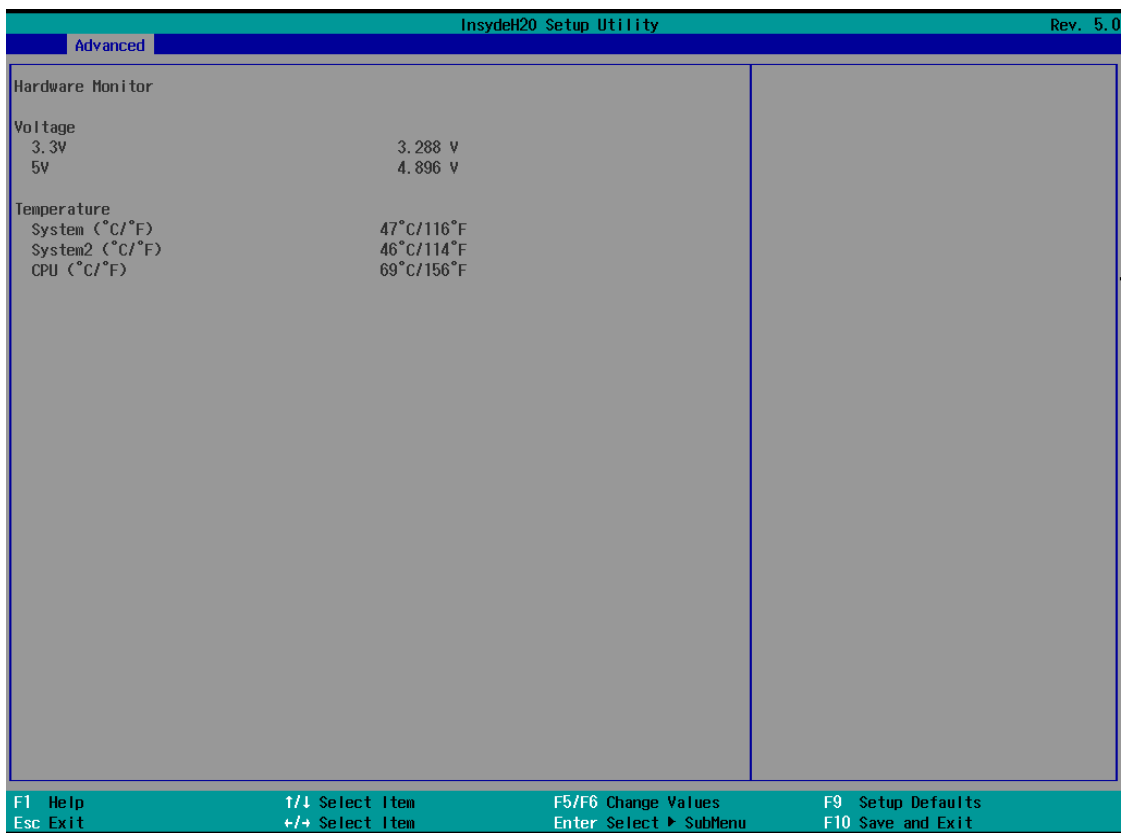

Console Redirection

When the Console Redirection Function is enabled, the console information will be output to both the HDMI monitor and through the serial port.

Options: Disabled (default), Enabled

Security Settings

This section allows users to configure security-related settings with a supervisor password and user password.

NOTE These settings will only appear in computers that have the TPM module.

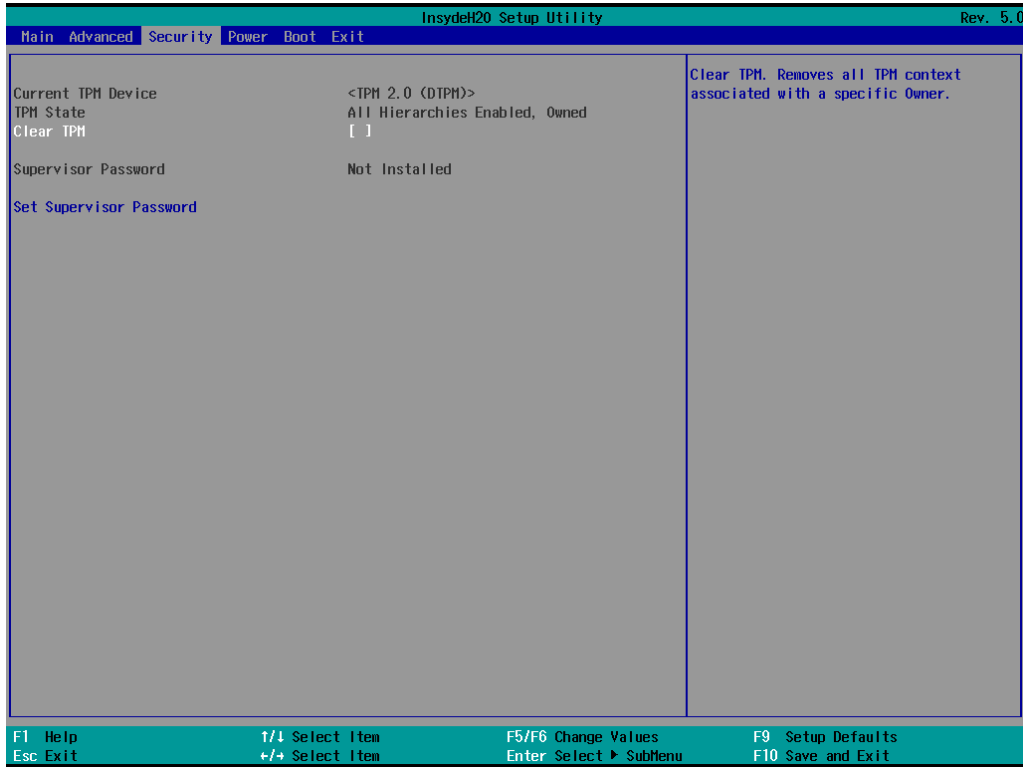

Current TPM Device

This item shows if the system has TPM device and its type.

TPM State

This item allows you view the status of current TPM settings.

Clear TPM

This item allows users to remove all TPM context associated with a specific owner.

Set Supervisor Password

This item allows you to set the supervisor password. Select the **Set Supervisor Password** option and enter the password and confirm the password again.

To delete the password, select the **Set Supervisor Password** option and enter the old password; leave the new password fields blank, and then press enter.

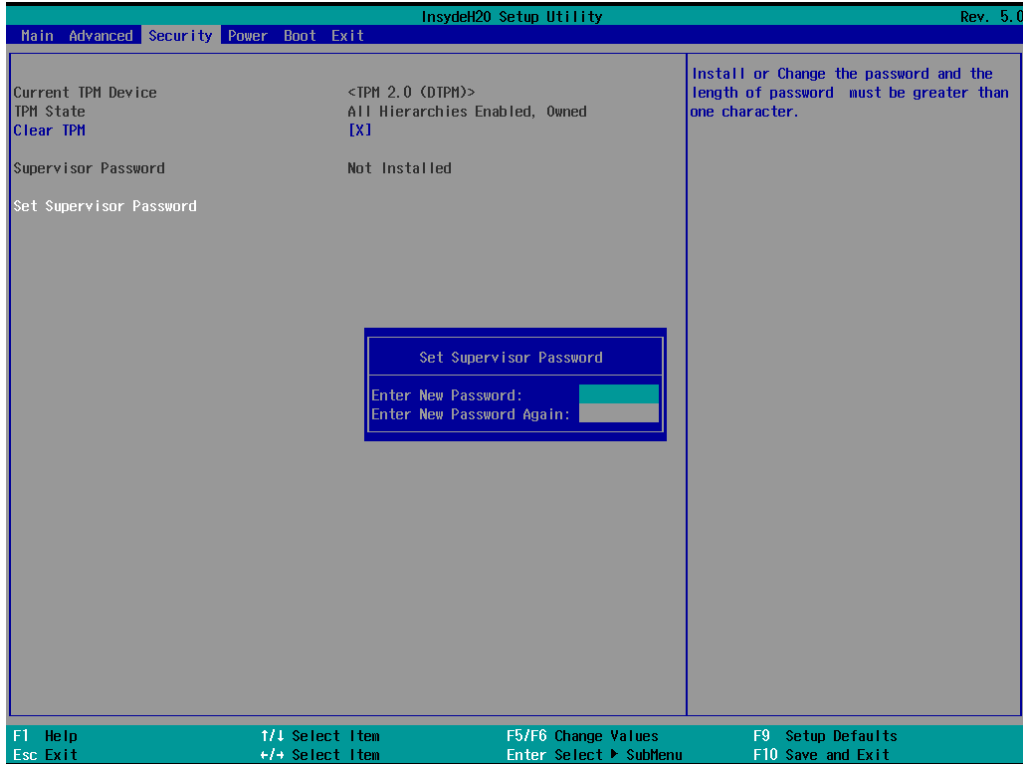

After setting the supervisor password, users can choose when asking input password screen will pop up.

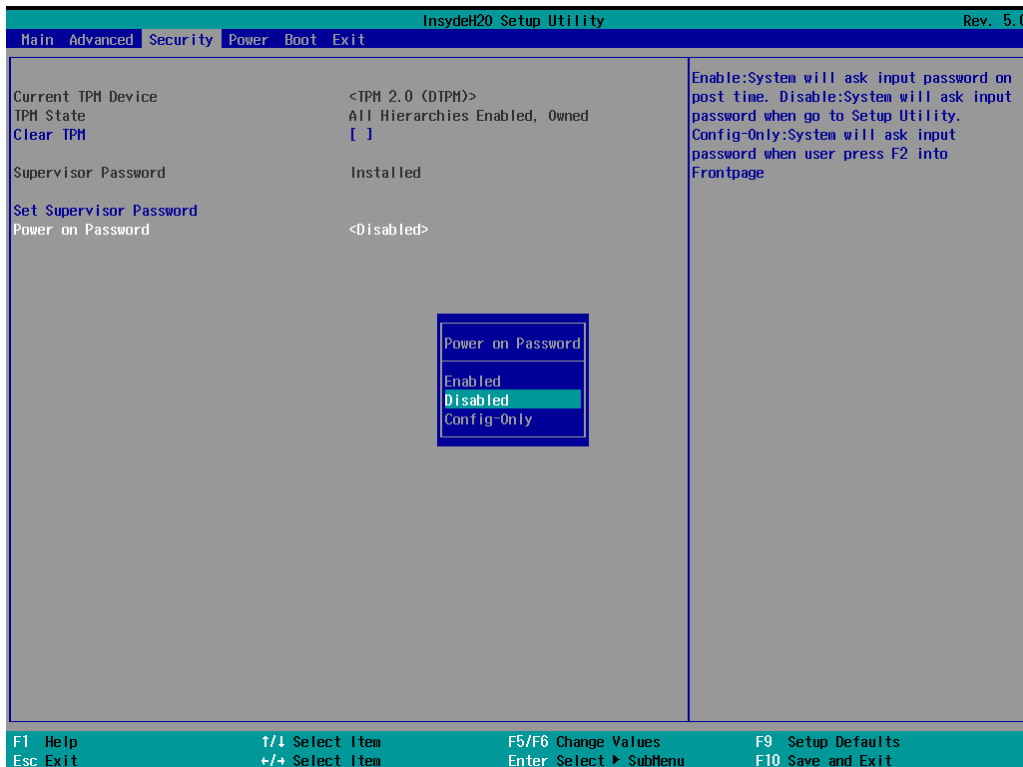

Enable: System will ask input password on post time.

Disable: System will ask for the password to go to the setup utility.

Config-Only: System will only ask for the password when you select the config (F2) option

Power Settings

The section allows users to configure power settings.

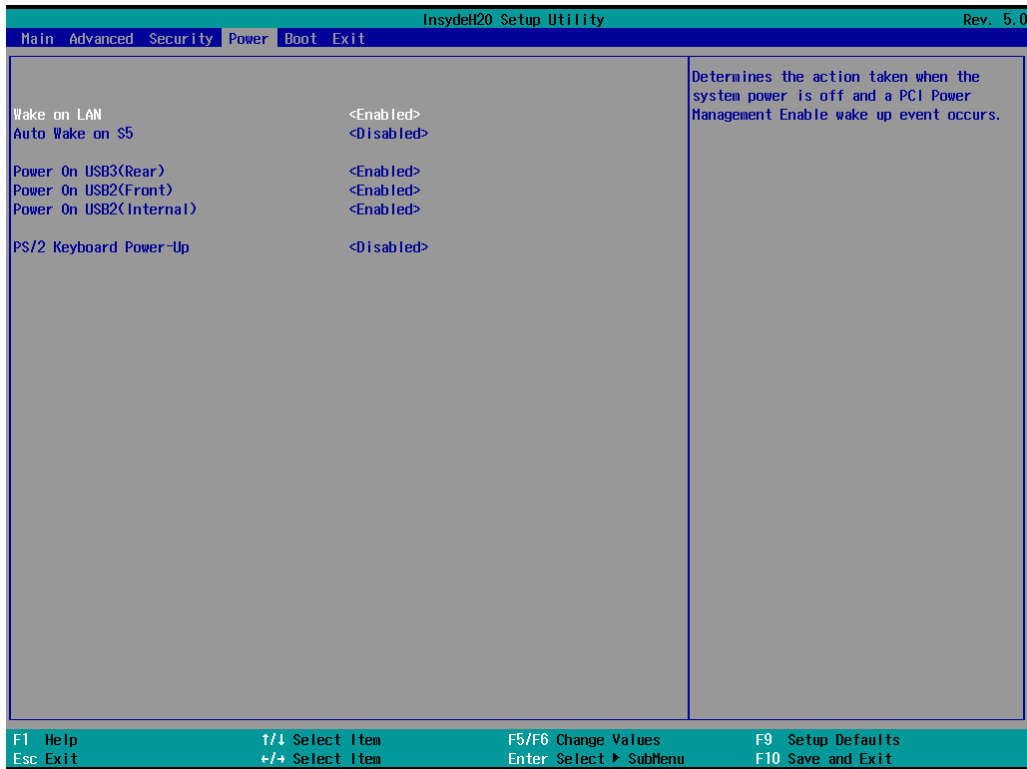

Wake On LAN

This feature is used to wake the system by a LAN device from a remote host.

Options: Disabled, Enabled (default)

Auto Wake On S5

This item allows you to configure the computer to wake from S5 status. S5 stands for Soft Off, where the PSU remains engaged but power to all other parts of the system is cut. Auto-wake on S5 schedules a soft-reboot at certain periodic times that may be specified in the BIOS.

Options: Disabled (default); By Every Day (user specifies a regular daily time when the computer will power up); By Day of Month (user specifies a regular day each month when the computer will power up)

Power On USB3 (rear panel)

This item allows users to power on or power off the USB ports on the rear panel.

Options: Disabled, Enabled (default)

Power On USB2 (front panel)

This item allows users to power on or power off the USB ports on the front panel.

Options: Disabled, Enabled (default)

Power On USB2 (built-in)

This item allows user to powers on or power off the internal USB port inside the computer.

Options: Disabled, Enabled (default)

PS/2 Keyboard Power-up

This item allows users to press CTRL+P to wake up the system that PSU remains engaged but power to all other parts of the system is cut.

Options: Disabled (default), Enabled

Boot Settings

The section allows users to configure boot settings.

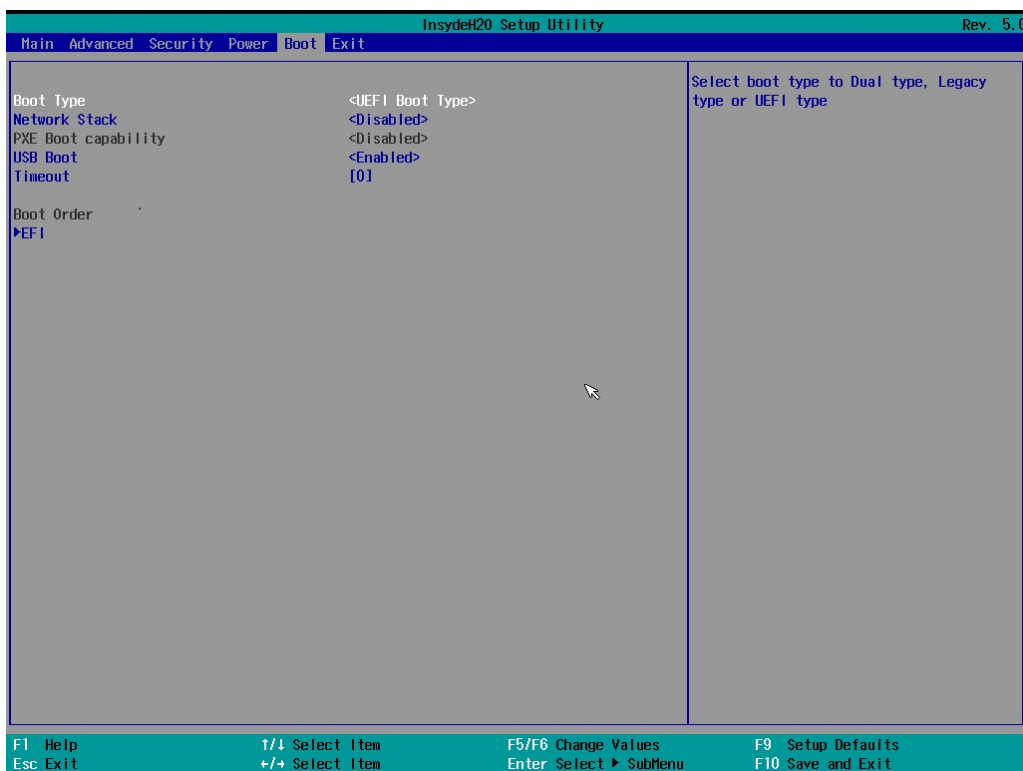

NOTE If you do not add any storage, you will not see the EFI option.

Boot Type

This item allows you to enable/disable the quick boot function.

Options: Dual Boot Type, Legacy Boot Type, UEFI Boot Type (default)

Network Stack

It deploys an Internet Protocol (IP) stack. The IP stack provides an application library to open/close connections to remote devices and send/receive data between the remote devices.

Options: Disabled (default), Enabled

PXE Boot capability

PXE Booting is booting a system over a network. This item allows users to start PXE over IPv4 or IPv6

Options: Disabled (default), UEFI: IPv4, UEFI: IPv6, UEFI: IPv4/IPv6

USB Boot

Set booting to USB boot devices capability.

Options: Enabled (Default), Disabled

Timeout

This item allows users to set the number of second that the firmware will wait before booting the original default boot selection.

EFI

This item allows users to select the boot order. Use F5 (move down) or F6 (move up) to change the value.

Exit Settings

The section allows users to exit the BIOS environment.

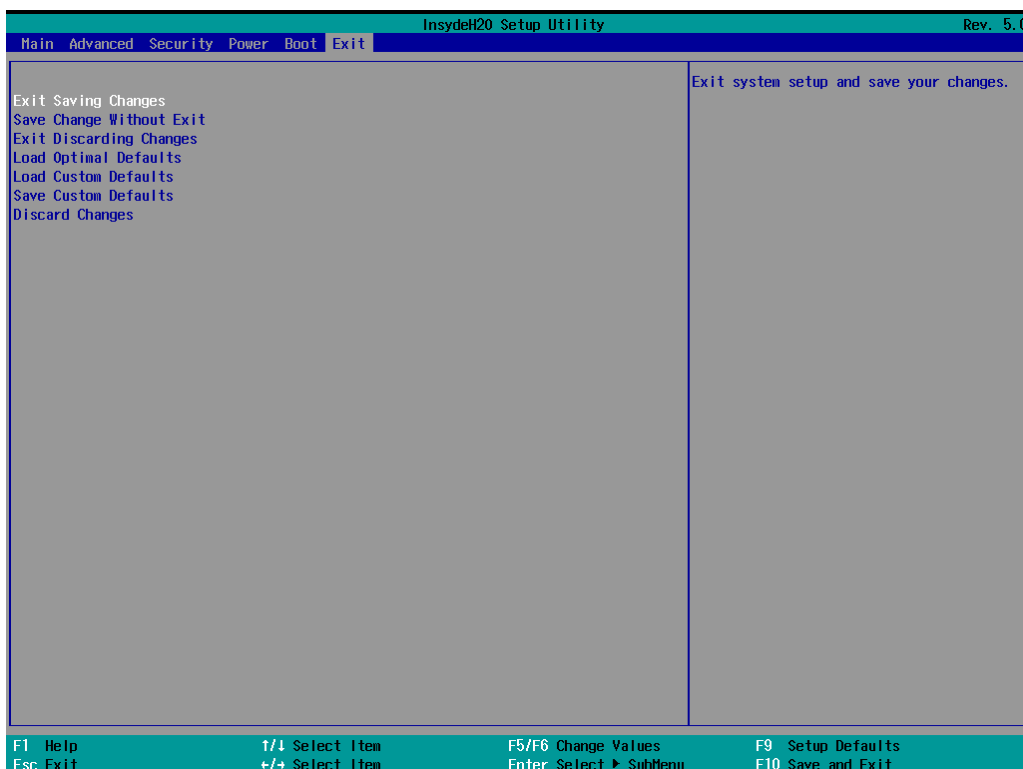

Exit Saving Changes

This item allows you to exit the BIOS environment and save the values you have just configured.

Options: Yes (default), No

Save Change Without Exit

This item allows you to save changes without exiting the BIOS environment.

Options: Yes (default), No

Exit Discarding Changes

This item allows you to exit without saving any changes that might have been made to the BIOS.

Options: Yes (default), No

Load Optimal Defaults

This item allows you to revert to the factory default BIOS values.

Options: Yes (default), No

Load Custom Defaults

This item allows you to load custom default values for the BIOS settings.

Options: Yes (default), No

Save Custom Defaults

This item allows you to save the current BIOS values as a "custom default" that may be reverted to at any time by the "load custom defaults" selection just above.

Options: Yes (default), No

Discard Changes

This item allows you to discard all settings you have just configured.

Options: Yes (default), No

Enable AMT

NOTE The AMT function is not supported for DA-682C-KL1 and DA-682C-KL3 models.

To enter the BIOS setup utility, press the **F2** while the system is booting up. The main **BIOS Setup** screen will appear. Five options will be available:

1. Select **Intel® Management Engine BIOS Extension** to enter the **AMT configuration**.

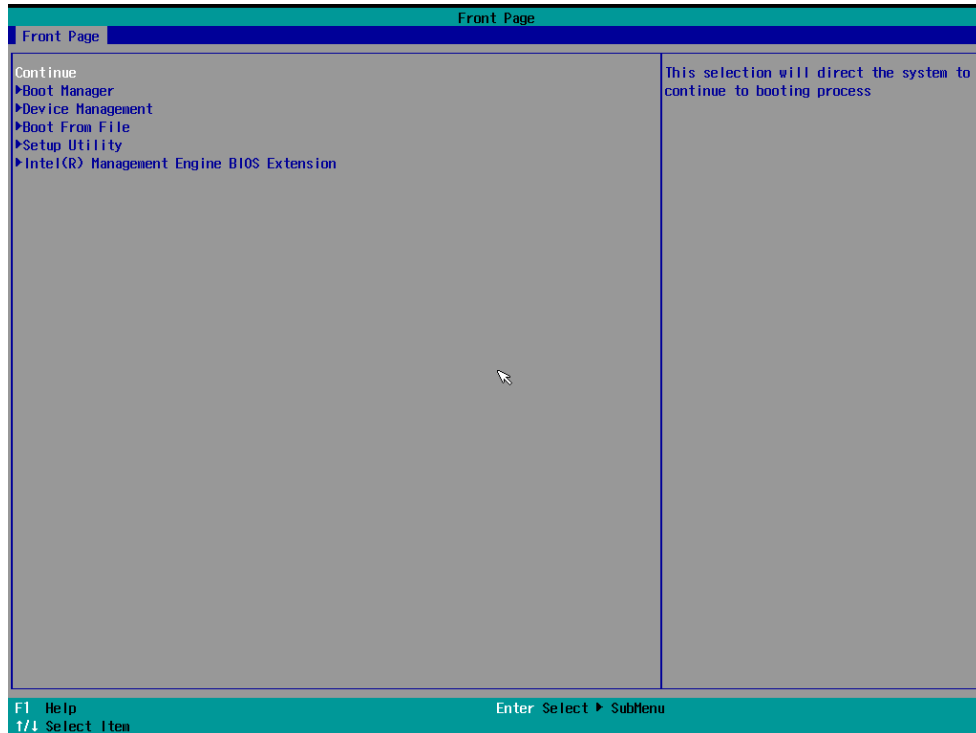

2. Press **<Enter>** to start the login procedure.

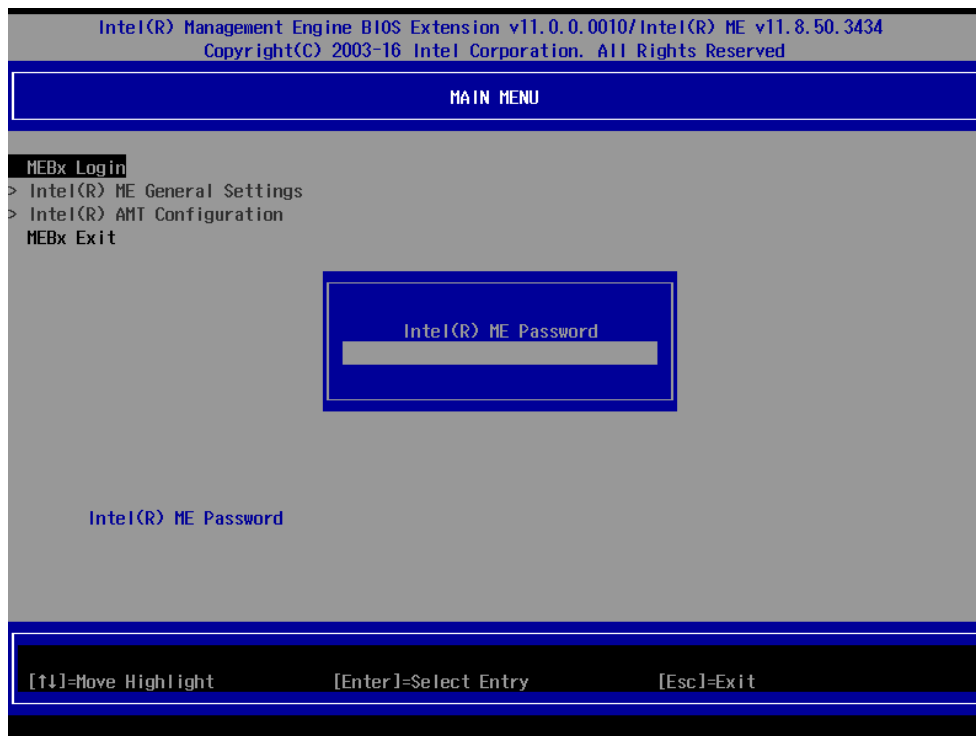

3. Type the default password: **admin**

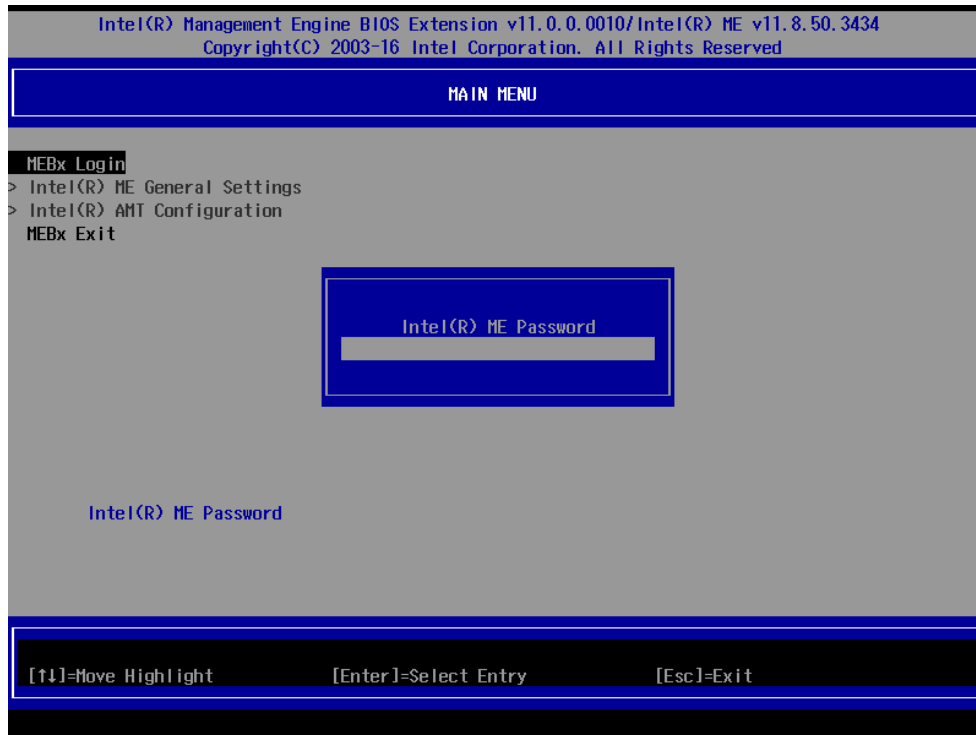

4. Type the new password. It must include both upper-case and lower-case characters, numbers, and special symbols. E.g., **Admin'12**.

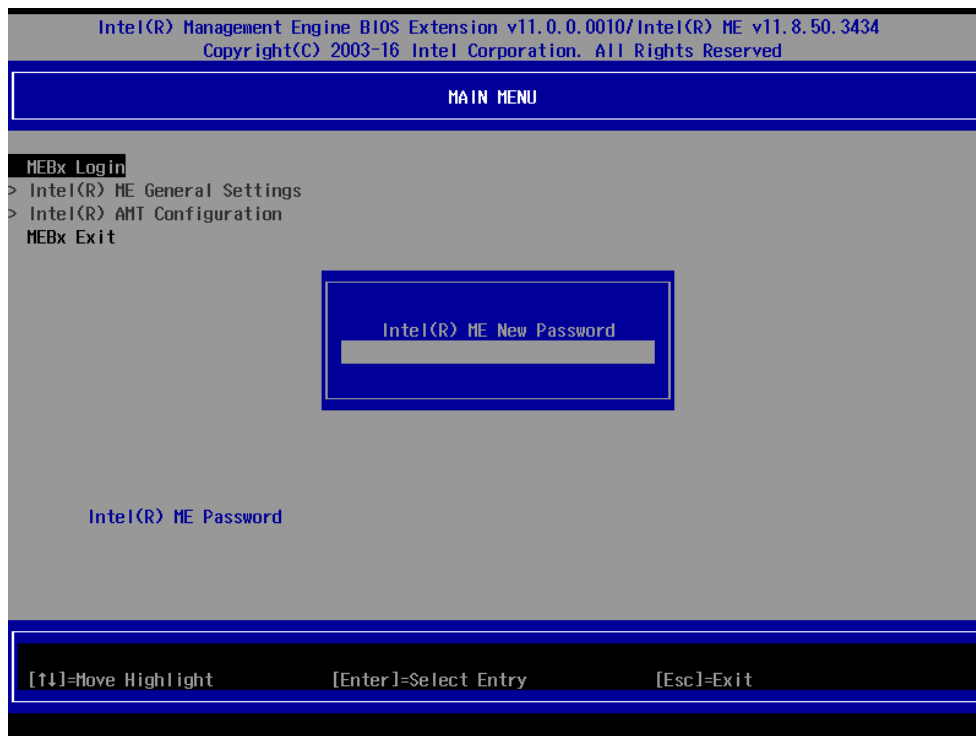

5. Select **Intel® AMT Configuration** to enable remote access without a local user present for consent, select **User Consent**, and then select **User Opt-in** and change the value to **None**.

- Set static IP or DHCP by request.

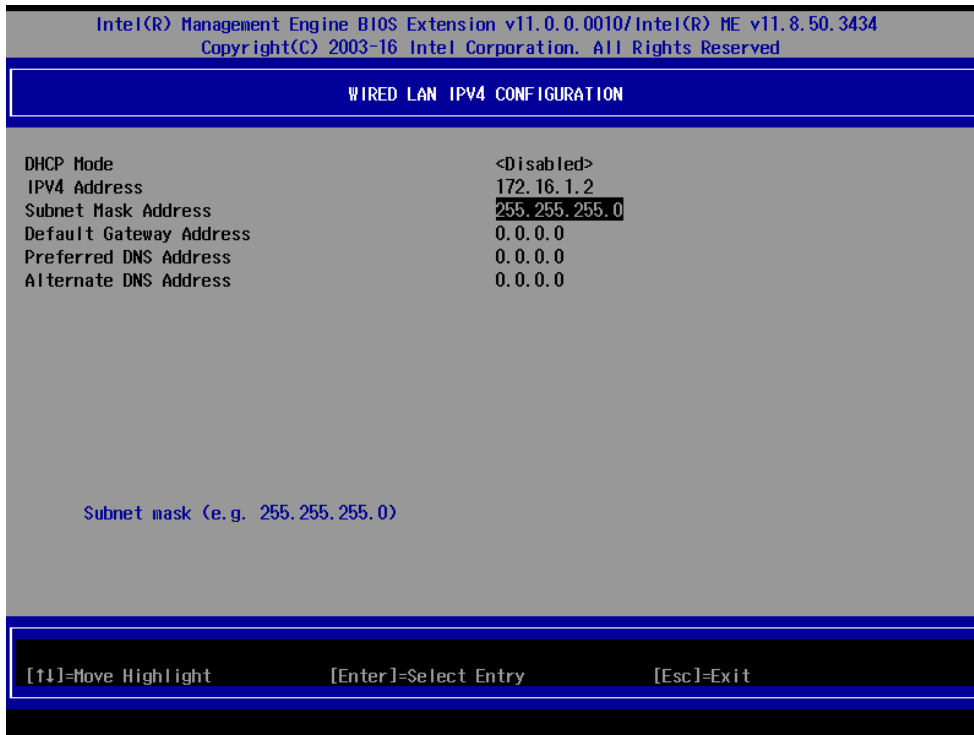

- Set **Activate Network Access** to enable remote access capability.

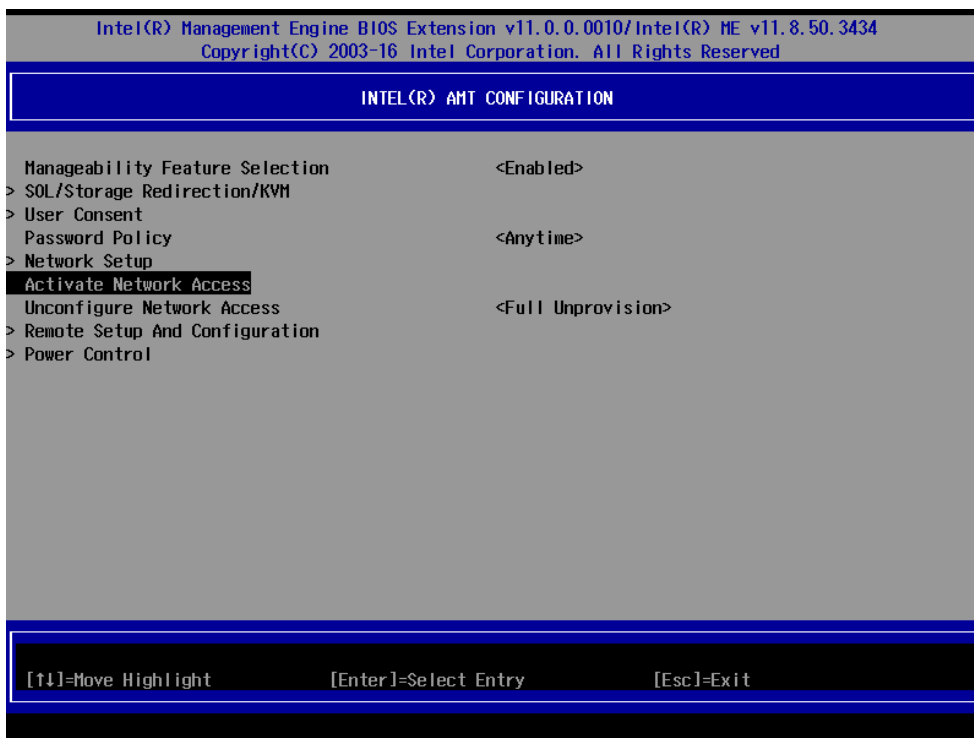

Use AMT

The DA-682C's AMT port is LAN1. You can use any of the available AMT tools to execute the remote management function. The easiest method is using a web browser.

1. Type the IP for your DA-682C that was configured in the AMT configuration with port **16992**. The AMT logon screen will appear.



2. Click on "Log On" and type the username (**admin**) and password to log in and control the DA-682C remotely.

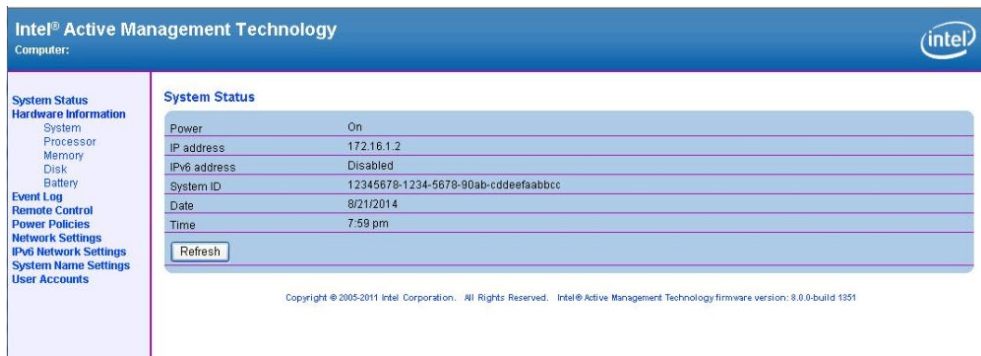

NOTE Refer to the Intel AMT Implementation and Reference Guide for details:

https://software.intel.com/sites/manageability/AMT_Implementation_and_Reference_Guide/default.htm?turl=WordDocuments%2Faccessingintelamtviathewebuiinterface.htm

Upgrading the BIOS

This section describes how to upgrade the BIOS. However, note that it is easy to permanently damage the computer when upgrading the BIOS. We strongly recommend that you contact Moxa's technical support staff for assistance in order to obtain all the necessary tools and the most current advice before attempting to upgrade the BIOS on any Moxa device.

Step 1: Create a Bootable USB Disk

Before upgrading the BIOS, every user should first create a bootable USB drive as a system boot device.

1. Search "format", then select **Create and format hard disk partitions**.

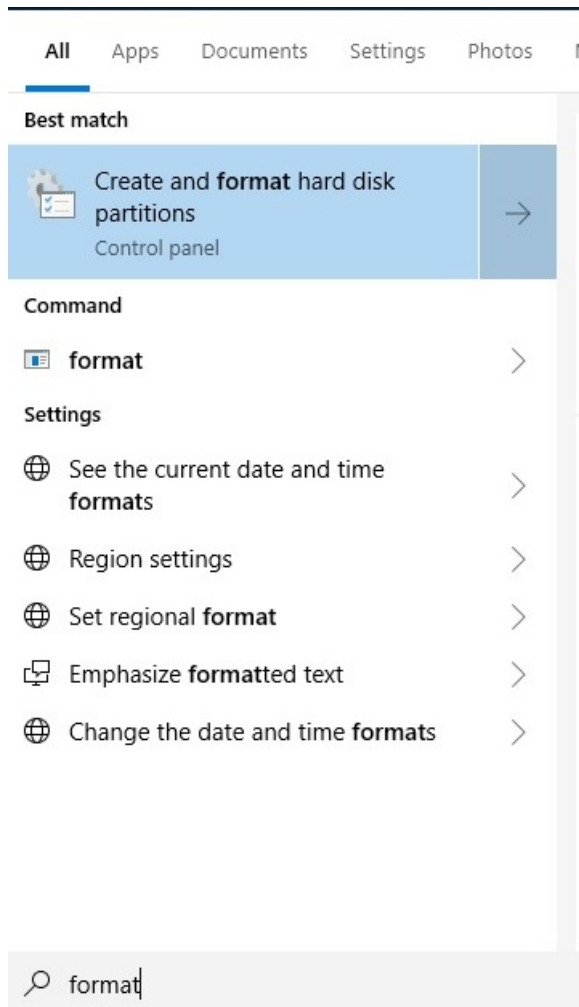

2. Right click on the USB disk then select "Format".

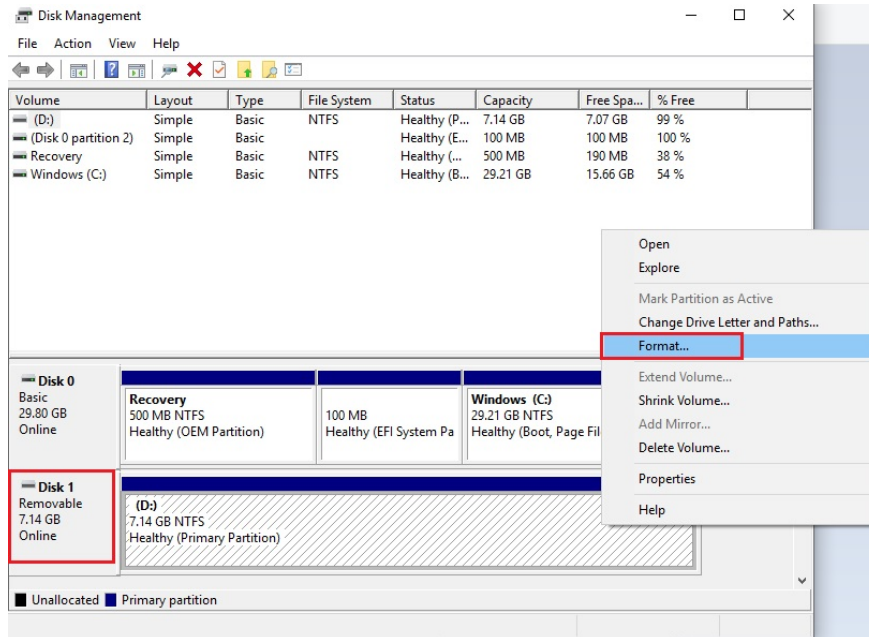

3. Select "FAT32", and click OK to start formatting.

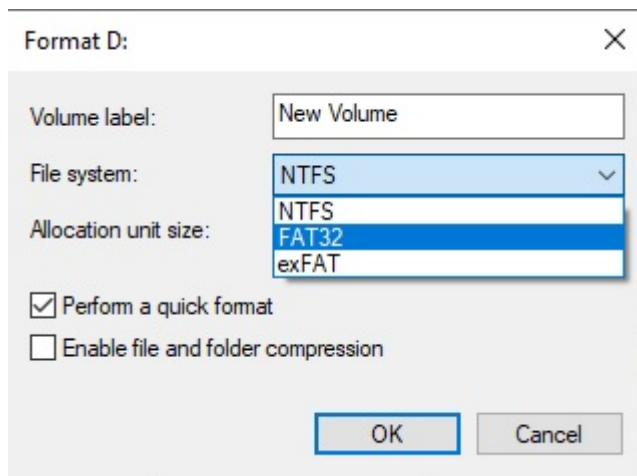

Step 2: Prepare the Upgrade File

You must use the BIOS upgrade installation file to upgrade the BIOS. Contact Moxa's technical department for assistance.

1. Get the BIOS upgrade file; it includes an **efi** folder and a file **xxxx.efi**.
2. Copy **efi** folder and **xxxx.efi** file to the Bootable USB Disk.

Step 3: Run the upgrade program on the Computer

1. Reboot the computer, and press F2 while booting up to go to the Boot Manager. If BIOS cannot recognize the USB drive as the boot devices, the USB drive could have no partition table. Use windows command line tool **diskpart** to rebuild the partition table.
2. Select the USB Disk



3. Screen will be going into the SHELL environment, type **fs0:** then, go to the directory where the upgrade file is located, type **:xxxxxx.efi** (the name is based on the upgrade file you get from Moxa).

```
Device mapping table
fs0      :Removable HardDisk - Alias hd24s0b blk0
         PciRoot(0x0)/Pci(0x14, 0x0)/USB(0x12, 0x0)/HD(1, MBR, 0x00DD3D80, 0x3F, 0xEB5FC1)
blk0     :Removable HardDisk - Alias hd24s0b fs0
         PciRoot(0x0)/Pci(0x14, 0x0)/USB(0x12, 0x0)/HD(1, MBR, 0x00DD3D80, 0x3F, 0xEB5FC1)
blk1     :Removable BlockDevice - Alias (null)
         PciRoot(0x0)/Pci(0x14, 0x0)/USB(0x12, 0x0)
hd24s0b  :Removable HardDisk - Alias fs0 blk0
         PciRoot(0x0)/Pci(0x14, 0x0)/USB(0x12, 0x0)/HD(1, MBR, 0x00DD3D80, 0x3F, 0xEB5FC1)

Shell> fs0:
fs0:\> xxxxxxx.efi
```

4. The upgrade program will run automatically. Wait patiently until the procedure is finished.

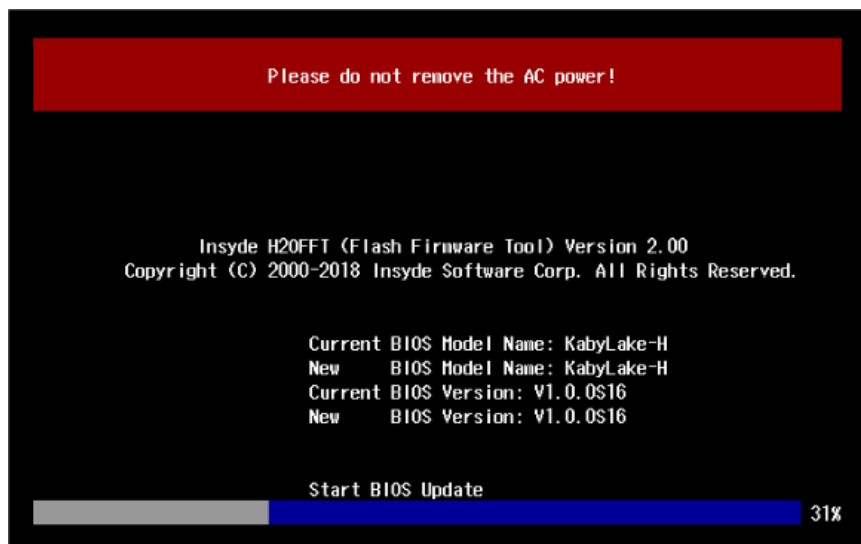

5. When the upgrade is finished, the computer will automatically reboot. You may check BIOS version on the Main page

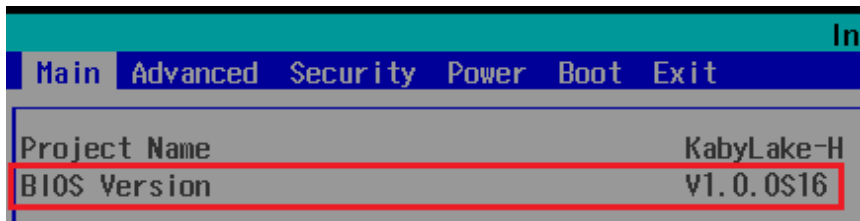

6. If the system have more than one boot device, you will see more than one fsx (x means number)

```
EFI Shell version 2.50 [22281.4149]
Current running mode 1.1.2
Device mapping table
fs0 :HardDisk - Alias hd33e0a2 blk0
      :PciRoot(0x0)/Pci(0x17,0x0)/Sata(0x4,0x0,0x0)/HD(2,GPT,0AC3B829-99B0-4FDE-844D-8A10C1D55C6C,0xFA000,0x32000)
fs1 :Removable HardDisk - Alias hd25r0b blk1
      :PciRoot(0x0)/Pci(0x14,0x0)/USB(0x11,0x0)/HD(1,HBR,0x00DD3D80,0x3F,0xEB5FC1)
fs2 :Removable BlockDevice - Alias f25s0 blk2
      :PciRoot(0x0)/Pci(0x14,0x0)/USB(0x12,0x0)
blk0 :HardDisk - Alias hd33e0a2 fs0
      :PciRoot(0x0)/Pci(0x17,0x0)/Sata(0x4,0x0,0x0)/HD(2,GPT,0AC3B829-99B0-4FDE-844D-8A10C1D55C6C,0xFA000,0x32000)
blk1 :Removable HardDisk - Alias hd25r0b fs1
      :PciRoot(0x0)/Pci(0x14,0x0)/USB(0x11,0x0)/HD(1,HBR,0x00DD3D80,0x3F,0xEB5FC1)
blk2 :Removable BlockDevice - Alias f25s0 fs2
      :PciRoot(0x0)/Pci(0x14,0x0)/USB(0x12,0x0)
blk3 :HardDisk - Alias (null)
      :PciRoot(0x0)/Pci(0x17,0x0)/Sata(0x4,0x0,0x0)/HD(1,GPT,5796BAEF-EC3F-447E-B4F1-21EB08DC5D57,0x800,0xF9800)
blk4 :HardDisk - Alias (null)
      :PciRoot(0x0)/Pci(0x17,0x0)/Sata(0x4,0x0,0x0)/HD(3,GPT,7C8FF3C6-53E8-4CF9-8141-65DF7EF04399,0x12C000,0x8000)
blk5 :HardDisk - Alias (null)
      :PciRoot(0x0)/Pci(0x17,0x0)/Sata(0x4,0x0,0x0)/HD(4,GPT,1AABAECE-BE17-AC27-AF60-E6C6997AC02,0x134000,0x3A6E800)
blk6 :BlockDevice - Alias (null)
      :PciRoot(0x0)/Pci(0x17,0x0)/Sata(0x4,0x0,0x0)
blk7 :Removable BlockDevice - Alias (null)
      :PciRoot(0x0)/Pci(0x14,0x0)/USB(0x11,0x0)
```

7. Go each **fsx** (x means number), then type **ls** to view the content of the boot device. If find the upgrade file, execute it

```
fs0:\> fs1:
fs1:\> ls
Directory of: fs1:\
06/27/19 11:43a <DIR>          16,384 efi
06/13/19 11:10a              17,974,704 820C100S16 efi
1 File(s) 17,974,704 bytes
1 Dir(s)
```



ATTENTION

Do NOT switch off the power supply during the BIOS upgrade, since doing so may cause the system to crash.

Safety Installation Instructions

1. RTC Battery Warning



ATTENTION

There is a risk of explosion if the wrong type of battery is used. To avoid this potential danger, always be sure to use the correct type of battery. Contact the Moxa RMA service team if you need to replace your battery.

Caution

There is a risk of explosion if the battery is replaced by an incorrect type. Dispose of used batteries according to the instructions on the battery.

2. Fuse Warning

CAUTION: For continued protection against fire, replace only with the same type and rating of fuse.

3. Rackmount Warning

The following or similar rackmount instructions are included with the installation instructions:

(1) Elevated Operating Ambient: If installed in a closed or multi-unit rack assembly, the operating ambient temperature of the rack environment may be greater than the room ambient temperature. Therefore, consideration should be given to installing the equipment in an environment compatible with the maximum ambient temperature (T_{ma}) specified by the manufacturer.

(2) Reduced Air Flow: Installation of the equipment in a rack should be such that the amount of air flow required for safe operation of the equipment is not compromised.

(3) Mechanical Loading: Mounting of the equipment in the rack should be such that a hazardous condition is not achieved due to uneven mechanical loading.

(4) Circuit Overloading: Consideration should be given to the connection of the equipment to the supply circuit and the effect that overloading of the circuits might have on overcurrent protection and supply wiring. Appropriate consideration of equipment nameplate ratings should be used when addressing this concern.

(5) Reliable Grounding: Reliable grounding of rack-mounted equipment should be maintained. Particular attention should be given to supply connections other than direct connections to the branch circuit (e.g., by using power strips).